



SERVICE CATALOG

PARTS, RETROFITS AND ACCESSORIES
TEILE, NACHRÜSTUNGEN UND ZUBEHÖR

SENEBOGEN

FOREWORD

We are pleased to provide you with an even more comprehensive reference work of the SENNEBOGEN service world with this edition of the service catalog, which contains many adjustments and additions across all chapters.

In particular, the first chapter in the area of service has been fundamentally restructured and, in addition to the previous contents, also contains the retrofit kits available for our machines as well as the common options for our cabins. In addition, a new chapter has been created for exhaust after-treatment and the chapter for equipment and attachments has been expanded to include new parts and accessories.

While browsing through this catalog you will surely find many more additions that we have included for you.

Your team from the
SENNEBOGEN Customer Service Center

VORWORT

Wir freuen uns, Ihnen mit dieser Ausgabe des Service Katalogs ein noch umfangreicheres Nachschlagewerk der SENNEBOGEN Service-Welt liefern zu können, das viele Anpassungen und Ergänzungen über alle Kapitel hinweg enthält.

Insbesondere das erste Kapitel im Bereich Service wurde grundlegend neu strukturiert und enthält zusätzlich zu den bisherigen Inhalten auch die für unsere Maschinen verfügbaren Nachrüstsätze sowie die gängigen Optionen für unsere Kabinen. Außerdem wurde ein neues Kapitel für die Abgasnachbehandlung geschaffen sowie die Anbaugeräte um neue Teile und Zubehör erweitert.

Beim Blättern in diesem Katalog werden Sie zudem sicherlich noch viele weitere Ergänzungen finden, die wir für Sie aufgenommen haben.

Ihr Team aus dem
SENNEBOGEN Customer Service Center



This Service Catalog is available online for download and in print.













Dieser Service-Katalog steht Ihnen auch online als Download und als Blätterkatalog zur Verfügung.

 www.sennebogen.com

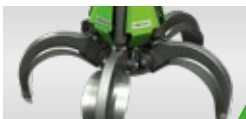
presented by / überreicht durch

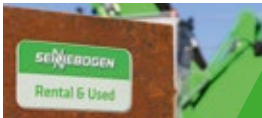
Impressum:

SENNEBOGEN
Maschinenfabrik GmbH
Hebbelstraße 30
94315 Straubing
Tel. +49 94 21/540-0
Fax +49 94 21/43882
www.sennebogen.de

1	SERVICE <i>SERVICE</i>		8
2	HYDRAULIC <i>HYDRAULIK</i>		152
3	ELECTRIC <i>ELEKTRIK</i>		163
4	ENGINE <i>MOTOR</i>		191
5	HEATER / AC SYSTEM <i>HEIZUNG / KLIMAAANLAGE</i>		196
6	REMANUFACTURED PARTS <i>AUSTAUSCHTEILE</i>		202
7	EXHAUST AFTERTREATMENT <i>ABGASNACHBEHANDLUNG</i>		208
8	EQUIPMENTS / ATTACHMENTS <i>AUSRÜSTUNGEN / ANBAUGERÄTE</i>		214
9	TOOLS <i>WERKZEUGE</i>		242
10	LACQUERS <i>LACKE</i>		243
11	SENNEBOGEN SVG <i>SENNEBOGEN SVG</i>		244
12	TRAINING <i>TRAININGSANGEBOTE</i>		246
13	SENNEBOGEN AFTER SALES <i>SENNEBOGEN AFTER SALES</i>		250
14	PARTS LISTS <i>STÜCKLISTEN</i>		256

CONTENT INHALT

1 Service Service



1.1	Service & Retrofit Kits <i>Service- & Nachrüstsätze</i>	8
1.2	Cameras: Spare Parts and Options <i>Kameras: Ersatzteile und Optionen</i>	104
1.3	Cabins: Spare Parts and Options <i>Kabinen: Ersatzteile und Optionen</i>	112
1.4	Climatic-Comfort-Seats <i>Klima-Komfort-Sitze</i>	120
1.5	Hydraulic <i>Hydraulik</i>	121
1.6	Engine <i>Motor</i>	124
1.7	Fuel System <i>Kraftstoffsystem</i>	126
1.8	Cooling System <i>Kühlsystem</i>	130
1.9	Air Filters <i>Luftfilter</i>	131
1.10	AdBlue Filters <i>AdBlue-Filter</i>	134
1.11	Heater / AC System <i>Heizung / Klimaanlage</i>	134
1.12	V-Belts <i>Keilriemen</i>	136
1.13	Gas Springs <i>Gasfedern</i>	140
1.14	Lubricants <i>Schmierstoffe</i>	143
1.15	Coolant Antifreeze <i>Kühlerfrostschutz</i>	148
1.16	DIN-Screws <i>DIN-Schrauben</i>	149
1.17	DIN Small Components <i>DIN-Kleinteile</i>	149
1.18	Central Lubrication System <i>Zentralschmierung</i>	150
1.19	O-Ring Kit <i>O-Ring-Set</i>	150
1.20	O-Rings (single pieces) <i>O-Ringe (einzeln)</i>	151
1.21	Seals for Gear Pumps <i>Dichtungen für Zahnradpumpen</i>	151

2 Hydraulic Hydraulik



2.1	Valves <i>Ventile</i>	152
2.2	Quick Lock Couplings <i>Schnellverschlusskupplungen</i>	157
2.3	SAE Flange Kit <i>SAE-Flansch-Set</i>	159
2.4	Fitting Kit <i>Verschraubungen-Set</i>	159
2.5	Vario Tool-Tool Kit <i>Vario Tool-Werkzeugsatz</i>	160
2.6	Vacuum Pump <i>Vakuumpumpe</i>	160
2.7	Hydraulic Measuring Box <i>Hydraulik-Messkoffer</i>	161
2.8	Measuring Turbine <i>Messturbine</i>	161
2.9	Measuring Box-Starter Kit <i>Messkoffer-Starterkit</i>	162
2.10	Oil Pressure Manometer Set <i>Öldruck-Manometer-Set</i>	162
2.11	Diagnostic Tool Kit FPT <i>Diagnosekoffer FPT</i>	162

3 Electric Elektrik



3.1	Switches <i>Schalter</i>	163
3.2	Pressure Switches <i>Druckschalter</i>	167
3.3	Limit Switches <i>Endschalter</i>	169

3.4	Solenoid Coils <i>Magnetspulen</i>	170
3.5	Sensors <i>Sensoren</i>	171
3.6	Connectors DT, DRC, HD <i>Steckverbinder DT, DRC, HD</i>	174
3.7	Connectors ILME <i>Steckverbinder ILME</i>	177
3.8	Connectors Harting <i>Steckverbinder Harting</i>	182
3.9	Adapter Cables <i>Adapterkabel</i>	186
3.10	Valve Connectors <i>Ventilstecker</i>	187
3.11	Electric Boxes Green Line <i>Elektrik-Koffer Green Line</i>	188
3.12	Electric Box Crane Line <i>Elektrik-Koffer Crane Line</i>	188
3.13	Relay Kit Telescopic Cranes <i>Relais-Kit Telekrane</i>	189
3.14	Connector Box <i>Steckverbinder-Koffer</i>	189
3.15	Electric Measuring Box <i>Elektrik-Messkoffer</i>	190
3.16	Electric Measuring Box 400 V <i>Elektrik-Messkoffer 400 V</i>	190

4 Engine Motor



4.1	Starter Motors <i>Anlasser</i>	191
4.2	Alternators <i>Lichtmaschinen</i>	192
4.3	Fuel Injectors <i>Einspritzdüsen</i>	193
4.4	Valve Cover Gaskets <i>Ventildeckeldichtungen</i>	194
4.5	Water Pumps and Thermostats <i>Wasserpumpen und Thermostate</i>	195
4.6	Turbo Chargers <i>Turbolader</i>	196

5 Heater / AC System Heizung / Klimaanlage



5.1	AC Compressors <i>Klimakompressoren</i>	196
5.2	Spare Parts <i>Ersatzteile</i>	197

6 Remanufactured Parts Austauschteile



6.1	Reman Program <i>AT-Programm</i>	202
6.2	Reman Program Overview <i>AT-Programm Übersicht</i>	204
6.3	Diesel Particulate Filters <i>Dieselpartikelfilter</i>	206

7 Exhaust Aftertreatment
Abgasnachbehandlung



- 7.1 Exhaust Aftertreatment – Overview
Abgasnachbehandlung – Übersicht 208
- 7.2 DOC Modules
DOC-Module 209
- 7.3 SCR Modules
SCR-Module 210
- 7.4 DRT Modules
DRT-Module 212
- 7.5 DPF Modules
DPF-Module 213

8 Equipments / Attachments
Ausrüstungen / Anbaugeräte



- 8.1 Multi Line Accessory Equipment
Multi Line Anbaugeräte 214
- 8.2 Orange Peel Grab SGM – Overview
Mehrschalengreifer SGM – Übersicht..... 216
- 8.3 Orange Peel Grab SGM (4 shells)
Mehrschalengreifer SGM (4 Schalen)..... 218
- 8.4 Orange Peel Grab SGM (5/6 shells)
Mehrschalengreifer SGM (5/6 Schalen) 220
- 8.5 Clamshell SGZ – Overview
Zweischalengreifer SGZ – Übersicht 222

- 8.6 Clamshell SGZ
Zweischalengreifer SGZ 224
- 8.7 Timber Grab SGH
Holzgreifer SGH 228
- 8.8 Sorting Grab SGR
Sortiergreifer SGR 230
- 8.9 Loading Hooks
Lasthaken 231
- 8.10 Scrap Magnets
Schrottmagnete 232
- 8.11 Maintenance Packages
Wartungspakete 233
- 8.12 Grab Accessories
Greifer Zubehör 235
- 8.13 Wear Parts
Verschleißteile 236
- 8.14 Grab Mounting Kits
Greiferanbausätze 238
- 8.15 Heavy-Duty Rope Sheaves
Heavy-Duty Seilrollen 239
- 8.16 Standard Rope Sheaves
Standard Seilrollen 240
- 8.17 Sliding Block – Repair Kits
Gleitstück – Reparatursätze 241

9 Tools
Werkzeuge



- 9.1 Service Box
Servicekoffer 242
- 9.2 Tool Box
Werkzeugkasten 242

10 Lacquers Lacke



10.1	Aerosol Paints <i>Sprühlacke</i>	243
10.2	Lacquers <i>Lacke</i>	243

11 SENNEBOGEN SVG SENNEBOGEN SVG

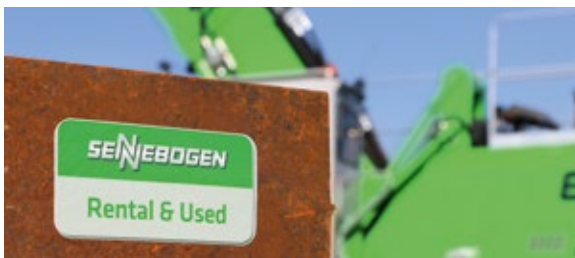

11.1	SENNEBOGEN SVG - Rebuild, Rental & Used Services <i>SENNEBOGEN SVG - Rebuild, Rental & Used Services</i>	244
------	--	-----

12 Training Trainingsangebote



12.1	Training <i>Trainingsangebote</i>	246
12.2	Operator Training <i>Bedienerschulungen</i>	247
12.3	Technical Training for Customers <i>Technisches Training für Endkunden</i>	248
12.4	Operator Licences <i>Fahrausweise</i>	249

13 SENNEBOGEN After Sales SENNEBOGEN After Sales



13.1	Sennebogen Customer Service Center <i>SENNEBOGEN Customer Service Center</i>	250
13.2	Dealer Information Center <i>Dealer Information Center</i>	252
13.3	Parts Catalog Online <i>ETK-Online</i>	253
13.4	Extended Warranty <i>Erweiterte Gewährleistung</i>	254

14 Parts Lists Stücklisten

Description / Beschreibung	Qty. / St.	No. / Nr.	Description / Beschreibung	Qty. / St.	No. / Nr.
245564 service package (250 h) / Service-Paket (250 h)	1	228568	HydroClean	1	168309
SSSE (FFT M45 Tier 4f, VPT)	1	043580	HydroClean	1	154547
return flow filter	1	043580	line filter	1	154547
straw filter	1	236336	254316 service package (250 h) / Service-Paket (250 h)	1	153950
leakage oil filter	1	228567	7266 (Q24 3 Tier 3a, VPT)	1	153950
Leckölfilter	1	228567	ventilation filter	1	150308
ventilation filter	1	168306	Bollwulfffilter	1	150308
Belebungsfilter	1	168306	auxiliary control filter	1	027376
auxiliary control filter	1	204076	Versteuertfilter	1	027376
Versteuertfilter	1	204076	leakage oil filter	1	164947
breather filter	1	103142	Leckölfilter	1	164947
Erdbefugnisfilter	1	103142	line filter	2	160307
engine oil filter	1	176434	Spezialschlammfilter	1	168306
Motorölfilter	1	176434	return flow filter	1	168306
Fuel Filter	1	176434	Backlauffilter	1	168306
Erdbefugnisfilter	1	176434	breather filter	1	168306
filter water separator	1	176434	Erdbefugnisfilter	1	168306

14.1	Service Packages (250 h) <i>Service-Pakete (250 h)</i>	256
14.2	Service Packages (500 h) <i>Service-Pakete (500 h)</i>	261
14.3	Service Packages (1000 h) <i>Service-Pakete (1000 h)</i>	263
14.4	Service Packages (2000 h) <i>Service-Pakete (2000 h)</i>	268
14.5	Inspection Sets (2000 h) <i>Inspektionssätze (2000 h)</i>	284
14.6	Service Boxes <i>Servicekoffer</i>	300
14.7	Hydraulic Boxes <i>Hydraulikkoffer</i>	307
14.8	Electric Boxes <i>Elektrikkoffer</i>	309
14.9	Tool Boxes <i>Werkzeugkoffer</i>	317

1.1 SERVICE & RETROFIT KITS

SERVICE & NACHRÜSTSÄTZE

Service Packages / Service-Pakete

SENNEBOGEN service packages include all* maintenance parts needed to carry out services in accordance with the maintenance plan.

- All maintenance parts in one package
- Easy ordering and handling
- Flexible service planning
- 7.0 % price advantage
- Low service costs

SENNEBOGEN Service-Pakete enthalten alle* Wartungsteile, die Sie für die Durchführung fachgerechter Services gemäß Wartungsplan benötigen.

- Alle Wartungsteile in einem Paket
- Einfache Bestellung und Handhabung
- Flexible Service-Planung
- 7,0 % Preisvorteil
- Niedrige Service-Kosten

Service Packages Type A Service-Pakete Typ A

A

The packages include all* maintenance parts for the first service after 250 operating hours.
Beinhaltet alle* Wartungsteile für den ersten Service nach 250 Betriebsstunden.

Service Packages Type 1 Service-Pakete Typ 1

1

The packages include all* maintenance parts for services after 500, 1500, 2500 ... operating hours.
Beinhaltet alle* Wartungsteile für Services nach 500, 1500, 2500 ... Betriebsstunden.

7,0%
Price Advantage
Preisvorteil



7,0%
Price Advantage
Preisvorteil



Service Packages Type 2 Service-Pakete Typ 2

2

The packages include all* maintenance parts for services after 1000, 3000, 5000 ... operating hours.
Beinhaltet alle* Wartungsteile für Services nach 1000, 3000, 5000 ... Betriebsstunden.

Service Packages Type 3 Service-Pakete Typ 3

3

The packages include all* maintenance parts for services after 2000, 4000, 6000 ... operating hours.
Beinhaltet alle* Wartungsteile für Services nach 2000, 4000, 6000 ... Betriebsstunden.

7,0%
Price Advantage
Preisvorteil



7,0%
Price Advantage
Preisvorteil



1.1 SERVICE & RETROFIT KITS / SERVICE & NACHRÜSTSÄTZE

Inspection Sets / Inspektionssätze



Inspection sets include all* maintenance parts needed to carry out all services during the first 2000 hours of operation.

- Maximum economic efficiency
- The sets fulfill the conditions of the SENNEBOGEN warranty through the use of genuine parts
- All standard maintenance parts in one package
- Increased flexibility during service planning
- Can be ordered with new machines
- 20 % price advantage

Inspektionssätze beinhalten alle Wartungsteile, die für die fachgerechte Durchführung aller Services während der ersten 2000 Betriebsstunden benötigt werden.*

- Maximale Wirtschaftlichkeit
- Erhalt des SENNEBOGEN Garantieanspruchs durch Verwendung von Original-Teilen
- Alle Standard-Wartungsteile in einem Paket
- Erhöhte Flexibilität bei Serviceplanung
- Mit Neumaschine bestellbar
- 20 % Preisvorteil



Retrofit Kits / Nachrüstätze

SENNEBOGEN offers a large number of standardized retrofit kits*, which are custom-built and fit the various machine types.

- Extension of the application area of the machine
- Coverage of individual requirements to the local conditions
- Coverage of industry-specific requirements
- All retrofit kits available for order with article number

SENNEBOGEN bietet eine Vielzahl standardisierter Nachrüstätze an, welche auf die verschiedenen Maschinentypen zugeschnitten sind.*

- Erweiterung des Einsatzbereichs der Maschine
- Deckung individueller Anforderungen an die lokalen Gegebenheiten
- Deckung branchenspezifischer Anforderungen
- Alle angebotenen Nachrüstätze direkt mit Artikelnummer bestellbar

1.1 SERVICE & RETROFIT KITS / SERVICE & NACHRÜSTSÄTZE

355E

Service Packages / Inspections Sets / Retrofit Kits
 Service-Pakete / Inspektionssätze / Nachrüstätze

Service Intervals
 Serviceintervalle

6000	3
5500	1
5000	2
4500	1
4000	3
3500	1
3000	2
2500	1
2000	3
1500	1
1000	2
500	1
250	A

Operating hours / Betriebsstunden



Service Packages
 Service-Pakete

	A	1	2	3
Service Packages / Service-Pakete				
Model / Modell				
Emission Standard / Abgasnorm				
Configuration / Ausstattung				
No. Nr.	245654	245655	245657	245661

Hydraulic Oil Filtration
 Hydraulikölfiltration

VF: standard HC: HydroClean
 VF: Standard HC: HydroClean

Water Separator
 Wasserabscheider

WA: standard WAH: heatable
 WA: Standard WAH: beheizbar



Inspection Sets
 Inspektionssätze

	VF	VF	HC	HC
	WA	WAH	WA	WAH
Inspection Sets / Inspektionssätze				
Model / Modell				
Emission Standard / Abgasnorm				
No. Nr.	245663			

1.1 SERVICE & RETROFIT KITS / SERVICE & NACHRÜSTSÄTZE

355E Under- and Uppercarriage / Unter- und Oberwagen

Model Modell	PLN PLN	Description Bezeichnung	No. Nr.
355E	PLN 15162	460/70 R 24 Camso MPT753 <i>460/70 R 24 Camso MPT753</i>	238794
355E	PLN 14711	500/70 R 24 Nokian TRI Steel - Recycling, steel reinforced <i>500/70 R 24 Nokian TRI Steel - Recycling, stahlverstärkt</i>	259686
355E	PLN 14029	460/70 R 24 Alliance MPT - Traction Profile for Agriculture and Forestry <i>460/70 R 24 Alliance MPT - Traktionsprofil Agrar- und Forstwirtschaft</i>	229349
355E	PLN 14714	460/70 R 24 Alliance Multiuse - Agriculture and Municipality (winter conditions) <i>460/70 R 24 Alliance Multiuse - Agrar- und Kommunaleinsatz (Wintereinsatz)</i>	229350
355E	PLN 14715	460/70 R 24 Michelin Bibload Hard Surface - Construction (aggressive conditions) <i>460/70 R 24 Michelin Bibload Hard Surface - Baustelle (aggressive Untergründe)</i>	223163
355E	PLN 14716	500/70 R 24 Michelin Bibload Hard Surface - Construction (aggressive conditions) <i>500/70 R 24 Michelin Bibload Hard Surface - Baustelle (aggressive Untergründe)</i>	233969
355E	PLN 14717	375/85 - 24 Camso MPT solid tires <i>375/85 - 24 Camso MPT Vollgummireifen</i>	259685
355E	PLN 16388	15,5 R 25 Bridgestone VSDL D2A <i>15,5 R 25 Bridgestone VSDL D2A</i>	252901
355E	PLN 14042	Automatic trailer coupling, height-adjustable, towing capacity max. 15 t <i>Anhängerzugvorrichtung mit automatischer Kupplung, höhenverstellbar, Anhängelast max. 15 t</i>	259691
355E	PLN 14043	Air brake system for towing operation <i>Druckluftbremsanlage für Anhängerbetrieb</i>	259692
355E	PLN 14037	Crawling mode function and speed limiter <i>Langsamfahreinrichtung und Geschwindigkeitsbegrenzung</i>	259698
355E	PLN 15614	Oscillating axle interlock rear <i>Pendelachssperre Hinterachse</i>	258279
355E	PLN 7172	ZH2 - Supplemental hydraulic circuit at rear end <i>ZH2 - Zusatzhydraulikkreis am Heck</i>	267203

355E Boom / Ausleger

Model Modell	PLN PLN	Description Bezeichnung	No. Nr.
355E	PLN 14054	Boom damping - Machines 355.0.1001 - 1137 <i>Auslegerdämpfung - Maschinen 355.0.1001 - 1137</i>	258283
355E	PLN 14054	Boom damping - from Machine 355.0.1138 <i>Auslegerdämpfung - ab Maschine 355.0.1138</i>	265439
355E	PLN 14056	Dirt scraper for telescopic arm <i>Schmutzabstreifer Teleskoparm</i>	258284
355E	PLN 14724	ZH1 - Continuous operation <i>ZH1 - Dauerfunktion</i>	259699
355E	PLN 1848	ZH3 - Supplemental hydraulic circuit on boom head - until machine 355.0.1117 <i>ZH3 - Zusatzhydraulikkreis am Auslegerkopf - bis Maschine 355.0.1117</i>	259710
355E	PLN 1848	ZH3 - Supplemental hydraulic circuit on boom head - from machine 355.0.1118 <i>ZH3 - Zusatzhydraulikkreis am Auslegerkopf - ab Maschine 355.0.1118</i>	259705
355E	PLN 14058	Power socket for front attachments <i>Steckdose für Frontanbaugeräte</i>	259697

1.1 SERVICE & RETROFIT KITS / SERVICE & NACHRÜSTSÄTZE

355E Lights & Travel Alarm / Beleuchtung & Fahralarm

Model Modell	PLN PLN	Description Bezeichnung	No. Nr.
355E	PLN 14059	2 LED headlights mounted on the basic boom: 1 piece on left side, 1 piece on right side <i>2 LED Scheinwerfer am Grundausleger: je 1 Stück links und 1 Stück rechts</i>	258280
355E	PLN 14733	All-round lighting package (incl. road traffic regulation lighting) <i>All-round Beleuchtungspaket (inkl. StVZO Beleuchtung)</i>	259695
355E	PLN 16096	Protective guards for headlights <i>Schutzgitter für StVZO-Scheinwerferbeleuchtung vorne</i>	259696
355E	PLN 10748	1 rotating beacon at the cab <i>1 Rundumleuchte an der Kabine</i>	259700

355E Camera Packages / Kamerapakete

Model Modell	PLN PLN	Description Bezeichnung	No. Nr.
355E	PLN 14047	Camera system – base package with 1 camera <i>Kamerasystem – Basispaket mit 1 Kamera</i>	258282

355E Functions / Funktionen

Model Modell	PLN PLN	Description Bezeichnung	No. Nr.
355E	PLN n/a	Central lubrication system telescopic arm – from machine 355.0.1118 <i>Zentralschmieranlage Teleskoparm – ab Maschine 355.0.1118</i>	259694
355E	PLN n/a	End position detection telescopic arm <i>Endlagenerkennung Teleskoparm</i>	259713
355E	PLN 16228	Automatic bucket repositioning <i>Automatische Schaufelrückführung</i>	260905
355E	PLN 14237	Air filter pre-cleaner, precleans approx. 98 % of abrasive smut <i>Vorabscheider für Luftfilter, Grobschmutz Abscheidegrad ca. 98 %</i>	259693
355E	PLN 14065	Certification for road traffic up to 20 km/h <i>Zulassung für Straßenverkehr nach StVZO bis 20 km/h</i>	259687
355E	PLN 14725	Certification for road traffic up to 30 km/h <i>Zulassung für Straßenverkehr nach StVZO bis 30 km/h</i>	259688
355E	PLN 14064	Certification for road traffic up to 40 km/h <i>Zulassung für Straßenverkehr nach StVZO bis 40 km/h</i>	259689
355E	PLN n/a	Joystick Height Extension <i>Joystick Erhöhung</i>	266045
355E	PLN 15319	SENtrack DS (Diesel, E-Series) <i>SENtrack DS (Diesel, E-Serie)</i>	260254

1.1 SERVICE & RETROFIT KITS / SERVICE & NACHRÜSTSÄTZE

718E Service Packages / Inspections Sets / Retrofit Kits Service-Pakete / Inspektionssätze / Nachrüstätze

Service Intervals Serviceintervalle

Operating hours / Betriebsstunden	6000	3
	5500	1
	5000	2
	4500	1
	4000	3
	3500	1
	3000	2
	2500	1
	2000	3
	1500	1
	1000	2
	500	1
	250	A



7,0%
Price Advantage
Preisvorteil

Service Packages Service-Pakete

Model Modell	Emission Standard Abgasnorm	Configuration Ausstattung	No. Nr.	No. Nr.	No. Nr.	No. Nr.
718E	EU Stage IV / Tier 4f	VF	227804	227806	227808	227810
		HC	227805	227806	227808	227811

Hydraulic Oil Filtration Hydraulikölfiltration

VF: standard HC: HydroClean
VF: Standard HC: HydroClean

Water Separator Wasserabscheider

WA: standard WAH: heatable
WA: Standard WAH: beheizbar

Inspection Sets Inspektionssätze

Model Modell	Emission Standard Abgasnorm	No. Nr.	No. Nr.	No. Nr.	No. Nr.
718E	EU Stage IV / Tier 4f	VF WA	VF WAH	HC WA	HC WAH
		227812	227812	227812	227813

20%
Price Advantage
Preisvorteil

1.1 SERVICE & RETROFIT KITS / SERVICE & NACHRÜSTSÄTZE

718E Undercarriage / Unterwagen

Model Modell	PLN PLN	Description Bezeichnung	No. Nr.
718E	PLN 13156	Cover plate with standard drill pattern for trailer coupling (MP18D, MP21E) <i>Konsole mit Standardbohrbild für Anhängerkupplung (MP18D, MP21E)</i>	184868
718E	PLN 11345	Protection for drive train, MP21E <i>Schutz für den Fahrtrieb, MP21E</i>	259490
718E	PLN 16279	Protection for drive train, MP21E, reinforced version <i>Schutz für den Fahrtrieb, MP21E, verstärkte Version</i>	271191

718E Uppercarriage / Oberwagen

Model Modell	PLN PLN	Description Bezeichnung	No. Nr.
718E	PLN 10694	Grated step on side of cab with hand rail (bolted) <i>Trittrost neben Kabine mit Geländer (geschraubt)</i>	261187
718E	PLN 13187	Low temperature package, diesel engine with electric preheating devices <i>Tiefemperatur-Paket, Dieselmotor mit elektrischen Vorheizgeräten</i>	271192
718E	PLN 13190	Electric preheating for hydraulic tank, 230 V / 400 V <i>Elektr. Hydrauliktankvorwärmung, 230 V / 400 V</i>	271195
718E	PLN 10687	Diesel refuelling pump (50 l/min) <i>Diesel-Betankungspumpe (50 l/min)</i>	255219
718E	PLN 13162	SENNEBOGEN Hydro Clean <i>SENNEBOGEN Hydro Clean</i>	269736
718E	PLN 12115	Hand rail at the upper structure, tiltable for transportation, diesel engine (EU Stage III A, IV / Tier 3, 4f) <i>Geländer am Oberwagen, abklappbar für Transport Dieselmotor (EU Stufe III A, IV / Tier 3, 4f)</i>	259277
718E	PLN 11166	Jump start connection (positive pole) <i>Fremdstart (Pluspol)</i>	260169
718E	PLN 15683	Cyclone air pre-cleaner – diesel engine EU Stage III A / Tier 3 <i>Zyklon-Vorabscheider – Dieselmotor EU Stufe III A / Tier 3</i>	259341
718E	PLN 15684	Cyclone air pre-cleaner – diesel engine EU Stage V / Tier 4f <i>Zyklon-Vorabscheider – Dieselmotor EU Stufe V / Tier 4f</i>	259342

718E Boom / Ausleger

Model Modell	PLN PLN	Description Bezeichnung	No. Nr.
718E	PLN 13702	Pressure indicator (boom cylinder) with Bargraph display (SENCON) and acoustical warning <i>Bargraph Druck-Anzeige (Hubzylinder) im SENCON mit akustischer Warnung</i>	260172
718E	PLN 16266	Tool Control – programmable for operation of various working tools <i>Tool Control – programmierbar für den Betrieb unterschiedlicher Arbeitsgeräte</i>	263627
718E	PLN 16021	Boom damping system 718E <i>Auslegerdämpfung 718E</i>	271190

1.1 SERVICE & RETROFIT KITS / SERVICE & NACHRÜSTSÄTZE

718E Lights & Travel Alarm / Beleuchtung & Fahralarm

Model Modell	PLN PLN	Description Bezeichnung	No. Nr.
718E	PLN 13175	2 LED headlight mounted on the basic boom <i>2 LED Scheinwerfer am Grundausleger</i>	259290
718E	PLN 16014	2 LED headlights for illumination at the side <i>2 LED Scheinwerfer für seitliche Ausleuchtung</i>	259348
718E	PLN 13932	1 LED headlight mounted on the counterweight heading backwards <i>1 LED Scheinwerfer auf dem Gegengewicht nach hinten gerichtet</i>	259321
718E	PLN 10749	2 rotating beacons at rear of machine with intermittent horn <i>2 Rundumleuchten am Heck des Gerätes mit Intervallhupe</i>	259261
718E	PLN 16500	2 rotating beacons at rear of machine with intermittent horn <i>2 Rundumleuchten am Heck des Gerätes mit Intervallhupe</i>	259364
718E	PLN 13183	Protection guard for integrated H4 headlight <i>Schutzgitter für H4 Einbauscheinwerfer</i>	259291
718E	PLN 13288	1 LED headlight mounted on the cab roof heading forwards <i>1 LED Scheinwerfer auf dem Kabinendach vorn</i>	259298
718E	PLN 10747	1 LED headlight mounted on the cab roof heading backwards <i>1 LED Scheinwerfer auf dem Kabinendach nach hinten</i>	255209
718E	PLN 10748	1 rotating beacon at the cab <i>1 Rundumleuchte an der Kabine</i>	256761
718E	PLN 5222	Intermittent horn for driving (travel alarm) <i>Intervallhupe für Fahren (Fahralarm)</i>	256762

718E Camera Packages / Kamerapakete

Model Modell	PLN PLN	Description Bezeichnung	No. Nr.
718E	---	---	---

718E Functions / Funktionen

Model Modell	PLN PLN	Description Bezeichnung	No. Nr.
718E	PLN 15319	SENtrack DS (Diesel, E-Series) <i>SENtrack DS (Diesel, E-Serie)</i>	265784

1.1 SERVICE & RETROFIT KITS / SERVICE & NACHRÜSTSÄTZE

723E Service Packages / Inspections Sets / Retrofit Kits Service-Pakete / Inspektionssätze / Nachrüstätze

Service Intervals
Serviceintervalle

Operating hours / Betriebsstunden	6000	3
	5500	1
	5000	2
	4500	1
	4000	3
	3500	1
	3000	2
	2500	1
	2000	3
	1500	1
	1000	2
	500	1
	250	A



Service Packages
Service-Pakete

Model Modell	Emission Standard Abgasnorm	Configuration Ausstattung	A	1	2	3
723E	EU Stage IV / Tier 4f	VF	231014	227806	227808	231015
		HC	224400	227806	227808	224403

Hydraulic Oil Filtration
Hydraulikölfiltration

VF: standard HC: HydroClean
VF: Standard HC: HydroClean

Water Separator
Wasserabscheider

WA: standard WAH: heatable
WA: Standard WAH: beheizbar



Inspection Sets
Inspektionssätze

Model Modell	Emission Standard Abgasnorm	VF WA	VF WAH	HC WA	HC WAH
723E	EU Stage IV / Tier 4f	231016	224404		

1.1 SERVICE & RETROFIT KITS / SERVICE & NACHRÜSTSÄTZE

723E Undercarriage / Unterwagen

Model Modell	PLN PLN	Description Bezeichnung	No. Nr.
723E	PLN 12608	Air tires 12.00-20 (8 units), Solideal Hauler <i>Luftreifen 12.00-20 (8-fach), Solideal Hauler</i>	271203
723E	PLN 14551	Tyre pressure monitoring <i>Reifendruck-Kontrollsystem</i>	271204
723E	PLN 12609	Fender (4 pieces) <i>Kotflügel (4 Stück)</i>	255414
723E	PLN 2239	Hitch (up to 200 kN pulling force, no vertical load) for wheeled machine (MF33E, MF36E, MF37E) <i>Rangierkupplung (bis max. 200 kN Zugkraft, keine Stützlast) für Mobilgerät (MF33E, MF36E, MF37E)</i>	271196

723E Uppercarriage / Oberwagen

Model Modell	PLN PLN	Description Bezeichnung	No. Nr.
723E	PLN 12824	Low temperature package, diesel engine with electric preheating devices <i>Tieftemperatur-Paket, Dieselmotor mit elektrischen Vorheizgeräten</i>	271205
723E	PLN 13281	Electric preheating for hydraulic tank, 230 V, diesel machine <i>Elektr. Hydrauliktankvorwärmung, 230 V für Dieselmotoren</i>	271195
723E	PLN 12615	SENNEBOGEN Hydro Clean <i>SENNEBOGEN Hydro Clean</i>	269738
723E	PLN 12635	Platform next to the cabin <i>Podest neben Kabine</i>	255820
723E	PLN 12620	Hand rail at the upper structure, removable for transportation (EU Stage IV / Tier 4f) <i>Geländer am Oberwagen, abschraubbar für Transport (EU Stufe IV / Tier 4f)</i>	255415
723E	PLN 10687	Diesel refuelling pump (50 l/min) <i>Diesel-Betankungspumpe (50 l/min)</i>	255219
723E	PLN 11166	Jump start connection (positive pole) <i>Fremdstart (Pluspol)</i>	260169
723E	PLN 15683	Cyclone air pre-cleaner - diesel engine EU Stage III A / Tier 3 <i>Zyklon-Vorabscheider - Dieselmotor EU Stufe III A / Tier 3</i>	259341
723E	PLN 15684	Cyclone air pre-cleaner - diesel engine EU Stage V / Tier 4f <i>Zyklon-Vorabscheider - Dieselmotor EU Stufe V / Tier 4f</i>	259342

723E Boom / Ausleger

Model Modell	PLN PLN	Description Bezeichnung	No. Nr.
723E	PLN 13702	Pressure indicator (boom cylinder) with Bargraph display (SENCON) and acoustical warning <i>Bargraph Druck-Anzeige (Hubzylinder) im SENCON mit akustischer Warnung</i>	261667
723E	PLN 12613	Boom damping system <i>Auslegerdämpfung</i>	238383
723E	PLN 15705 + 15706	Hoist limit switch for loading boom - function hoist up / stick out <i>Hubbegrenzung für Kompaktausleger und Greiferstiel</i>	271197
723E	PLN 11813	Ball valves for hydraulic piping grab open/close and grab rotating <i>Kugelhähne für die Hydraulikleitungen Greifer auf/zu und Greifer drehen</i>	700041

1.1 SERVICE & RETROFIT KITS / SERVICE & NACHRÜSTSÄTZE

723E Lights & Travel Alarm / Beleuchtung & Fahralarm

Model Modell	PLN PLN	Description Bezeichnung	No. Nr.
723E	PLN 10747	1 LED headlight mounted on the cab roof heading backwards <i>1 LED Scheinwerfer auf dem Kabinendach nach hinten</i>	259254
723E	PLN 13928	2 LED headlights mounted on the stick: 1 piece on left side, 1 piece on right side <i>2 LED Scheinwerfer am Stiel: je 1 Stück links und 1 Stück rechts</i>	259310
723E	PLN 12637	2 LED headlight mounted on the compact boom <i>2 LED Scheinwerfer am Kompaktausleger</i>	259282
723E	PLN 13930	1 LED headlight mounted on the compact boom upper side <i>1 LED Scheinwerfer am Kompaktausleger oben</i>	259315
723E	PLN 13288	1 LED headlight mounted on the cab roof heading forwards <i>1 LED Scheinwerfer auf dem Kabinendach vorn</i>	259300
723E	PLN 13931	2 LED headlights mounted on the sides of the upper-carriage: 1 piece on left side, 1 piece on right side <i>2 LED Scheinwerfer seitlich auf dem Oberwagen: je 1 Stück links und 1 Stück rechts</i>	259319
723E	PLN 13932	1 LED headlight mounted on the counterweight heading backwards <i>1 LED Scheinwerfer auf dem Gegengewicht nach hinten gerichtet</i>	259321
723E	PLN 10749	2 rotating beacons at rear of machine with intermittent horn <i>2 Rundumleuchten am Heck des Gerätes mit Intervallhupe</i>	257768
723E	PLN 16500	2 rotating beacons at rear of machine with intermittent horn <i>2 Rundumleuchten am Heck des Gerätes mit Intervallhupe</i>	258261
723E	PLN 10748	1 rotating beacon at the cab <i>1 Rundumleuchte an der Kabine</i>	259259
723E	PLN 5222	Intermittent horn for driving (travel alarm) <i>Intervallhupe für Fahren (Fahralarm)</i>	259241

723E Camera Packages / Kamerapakete

Model Modell	PLN PLN	Description Bezeichnung	No. Nr.
723E	---	---	---

723E Functions / Funktionen

Model Modell	PLN PLN	Description Bezeichnung	No. Nr.
723E	PLN 15319	SENtrack DS (Diesel, E-Series) <i>SENtrack DS (Diesel, E-Serie)</i>	265784

1.1 SERVICE & RETROFIT KITS / SERVICE & NACHRÜSTSÄTZE

730E Service Packages / Inspections Sets / Retrofit Kits Service-Pakete / Inspektionssätze / Nachrüstätze

Service Intervals Serviceintervalle

Operating hours / Betriebsstunden	6000	3
	5500	1
	5000	2
	4500	1
	4000	3
	3500	1
	3000	2
	2500	1
	2000	3
	1500	1
	1000	2
	500	1
	250	A



7,0%
Price Advantage
Preisvorteil

Service Packages Service-Pakete

Model Modell	Emission Standard Abgasnorm	Configuration Ausstattung	No. Nr.	No. Nr.	No. Nr.	No. Nr.
730E	EU Stage IV / Tier 4f	VF	231017	227806	224544	231018
		HC	224542	227806	224544	224545
	EU Stage V / Tier 4f	VF	231017	227806	224544	282031
		HC	224542	227806	224544	282030

Hydraulic Oil Filtration Hydraulikölfiltration

VF: standard HC: HydroClean
VF: Standard HC: HydroClean

Water Separator Wasserabscheider

WA: standard WAH: heatable
WA: Standard WAH: beheizbar

Inspection Sets Inspektionssätze

20%
Price Advantage
Preisvorteil

Model Modell	Emission Standard Abgasnorm	No. Nr.	No. Nr.	No. Nr.	No. Nr.
730E	EU Stage IV / Tier 4f		231019		224546
	EU Stage V / Tier 4f		282029		282028

1.1 SERVICE & RETROFIT KITS / SERVICE & NACHRÜSTSÄTZE

730E Undercarriage / Unterwagen

Model Modell	PLN PLN	Description Bezeichnung	No. Nr.
730E	PLN 12608	Air tires 12.00-20 (8 units), Solideal Hauler <i>Luftreifen 12.00-20 (8-fach), Solideal Hauler</i>	271203
730E	PLN 14551	Tyre pressure monitoring <i>Reifendruck-Kontrollsystem</i>	271204
730E	PLN 12976	Fender (4 pieces) <i>Kotflügel (4 Stück)</i>	271208
730E	PLN 2239	Hitch (up to 200 kN pulling force, no vertical load) for wheeled machine (MF33E, MF36E, MF37E) <i>Rangierkupplung (bis max. 200 kN Zugkraft, keine Stützlast) für Mobilgerät (MF33E, MF36E, MF37E)</i>	271196

730E Uppercarriage / Oberwagen

Model Modell	PLN PLN	Description Bezeichnung	No. Nr.
730E	PLN 12982	Hand rail at the upper structure, removable for transportation <i>Geländer am Oberwagen, abschraubbar für Transport</i>	259285
730E	PLN 12997	Low temperature package, diesel engine with electric preheating devices <i>Tieftemperatur-Paket, Dieselmotor mit elektrischen Vorheizgeräten</i>	271211
730E	PLN 10517	Electric preheating for hydraulic tank, 230 V, diesel machine <i>Elektr. Hydrauliktankvorwärmung, 230 V für Dieselmotoren</i>	271195
730E	PLN 10687	Diesel refuelling pump (50 l/min) <i>Diesel-Betankungspumpe (50 l/min)</i>	269740
730E	PLN 13162	SENNEBOGEN Hydro Clean <i>SENNEBOGEN Hydro Clean</i>	269742
730E	PLN 11166	Jump start connection (positive pole) <i>Fremdstart (Pluspol)</i>	260169
730E	PLN 16056	Cyclone air pre-cleaner - diesel engine EU Stage III A, V / Tier 3, 4f <i>Zyklon-Vorabscheider - Dieselmotor EU Stufe III A, V / Tier 3, 4f</i>	259351

730E Boom / Ausleger

Model Modell	PLN PLN	Description Bezeichnung	No. Nr.
730E	PLN 12979	Boom Damping System <i>Auslegerdämpfung</i>	265442
730E	PLN 15705 + 15706	Hoist limit switch for loading boom - function hoist up/stick out <i>Hubbegrenzung für Kompaktausleger und Greiferstiel</i>	271214
730E	PLN 13920	Pressure indicator (boom cylinder) with Bargraph display (SENCON) and acoustical warning <i>Bargraph Druck-Anzeige (Hubzylinder) im SENCON mit akustischer Warnung</i>	260182
730E	PLN 11813	Ball valves for hydraulic piping grab open/close and grab rotating <i>Kugelhähne für die Hydraulikleitungen Greifer auf/zu und Greifer drehen</i>	260171

1.1 SERVICE & RETROFIT KITS / SERVICE & NACHRÜSTSÄTZE

730E Lights & Travel Alarm / Beleuchtung & Fahralarm

Model Modell	PLN PLN	Description Bezeichnung	No. Nr.
730E	PLN 10747	1 LED headlight mounted on the cab roof heading backwards <i>1 LED Scheinwerfer auf dem Kabinendach nach hinten</i>	259254
730E	PLN 13928	2 LED headlights mounted on the stick: 1 piece on left side, 1 piece on right side <i>2 LED Scheinwerfer am Stiel: je 1 Stück links und 1 Stück rechts</i>	259310
730E	PLN 12637	2 LED headlight mounted on the compact boom <i>2 LED Scheinwerfer am Kompaktausleger</i>	259282
730E	PLN 13930	1 LED headlight mounted on the compact boom upper side <i>1 LED Scheinwerfer am Kompaktausleger oben</i>	259315
730E	PLN 13288	1 LED headlight mounted on the cab roof heading forwards <i>1 LED Scheinwerfer auf dem Kabinendach vorn</i>	259300
730E	PLN 13931	2 LED headlights mounted on the sides of the upper-carriage: 1 piece on left side, 1 piece on right side <i>2 LED Scheinwerfer seitlich auf dem Oberwagen: je 1 Stück links und 1 Stück rechts</i>	259319
730E	PLN 13932	1 LED headlight mounted on the counterweight heading backwards <i>1 LED Scheinwerfer auf dem Gegengewicht nach hinten gerichtet</i>	259323
730E	PLN 16500	2 rotating beacons at rear of machine with intermittent horn <i>2 Rundumleuchten am Heck des Gerätes mit Intervallhupe</i>	259261
730E	PLN 10748	1 rotating beacon at the cab <i>1 Rundumleuchte an der Kabine</i>	259259
730E	PLN 10749	2 rotating beacons at rear of machine with intermittent horn <i>2 Rundumleuchten am Heck des Gerätes mit Intervallhupe</i>	257768
730E	PLN 5222	Intermittent horn for driving (travel alarm) <i>Intervallhupe für Fahren (Fahralarm)</i>	259241

730E Camera Packages / Kamerapakete

Model Modell	PLN PLN	Description Bezeichnung	No. Nr.
730E	---	---	---

730E Functions / Funktionen

Model Modell	PLN PLN	Description Bezeichnung	No. Nr.
730E	PLN 15319	SENtrack DS (Diesel, E-Series) <i>SENtrack DS (Diesel, E-Serie)</i>	265782

1.1 SERVICE & RETROFIT KITS / SERVICE & NACHRÜSTSÄTZE

735E

Service Packages / Inspections Sets / Retrofit Kits
 Service-Pakete / Inspektionssätze / Nachrüstätze

Service Intervals
 Serviceintervalle

6000	3
5500	1
5000	2
4500	1
4000	3
3500	1
3000	2
2500	1
2000	3
1500	1
1000	2
500	1
250	A

Operating hours / Betriebsstunden



Service Packages
 Service-Pakete

	A	1	2	3
Model Modell				
Emission Standard Abgasnorm				
Configuration Ausstattung				
No. Nr.				
735E				

Hydraulic Oil Filtration
 Hydraulikölfiltration

VF: standard HC: HydroClean
 VF: Standard HC: HydroClean

Water Separator
 Wasserabscheider

WA: standard WAH: heatable
 WA: Standard WAH: beheizbar



Inspection Sets
 Inspektionssätze

	VF	VF	HC	HC
	WA	WAH	WA	WAH
Model Modell				
Emission Standard Abgasnorm				
No. Nr.				
735E				

1.1 SERVICE & RETROFIT KITS / SERVICE & NACHRÜSTSÄTZE

735E Undercarriage / Unterwagen

Model Modell	PLN PLN	Description Bezeichnung	No. Nr.
735E	PLN 12042	Air tires 14.00-24 (8 units), Michelin XZM <i>Luftrreifen 14.00-24 (8-fach), Michelin XZM</i>	271401
735E	PLN 14551	Tyre pressure monitoring <i>Reifendruck-Kontrollsystem</i>	271204
735E	PLN 12043	Fender (4 pieces) <i>Kotflügel (4 Stück)</i>	271398
735E	PLN 2239	Hitch (up to 200 kN pulling force, no vertical load) for wheeled machine (MF33E, MF36E, MF37E) <i>Rangierkupplung (bis max. 200 kN Zugkraft, keine Stützlast) für Mobilgerät (MF33E, MF36E, MF37E)</i>	271196

735E Uppercarriage / Oberwagen

Model Modell	PLN PLN	Description Bezeichnung	No. Nr.
735E	PLN 12828	Low temperature package, diesel engine with electric preheating devices <i>Tieftemperatur-Paket, Dieselmotor mit elektrischen Vorheizgeräten</i>	271402
735E	PLN 10517	Electric preheating for hydraulic tank, 230 V, diesel machine (EU Stage III A / Tier 4i) <i>Elektr. Hydrauliktankvorwärmung, 230 V für Dieselmotoren (EU Stufe III A / Tier 4i)</i>	271410
735E	PLN 10517	Electric preheating for hydraulic tank, 230 V, diesel machine (EU Stage IV / Tier 4f) <i>Elektr. Hydrauliktankvorwärmung, 230 V für Dieselmotoren (EU Stufe IV / Tier 4f)</i>	271195
735E	PLN 10687	Diesel refuelling pump (50 l/min) <i>Diesel-Betankungspumpe (50 l/min)</i>	269740
735E	PLN 12049	SENNEBOGEN Hydro Clean <i>SENNEBOGEN Hydro Clean</i>	269744
735E	PLN 16057	Cyclone air pre-cleaner – diesel engine EU Stage III A / Tier 3 and EU Stage V / Tier 4 final <i>Zyklon-Vorabscheider – Dieselmotor EU Stufe III A / Tier 3 und EU Stufe V / Tier 4 final</i>	259352
735E	PLN 12635	Platform next to the cabin <i>Podest neben Kabine</i>	255820
735E	PLN 11166	Jump start connection (positive pole) <i>Fremdstart (Pluspol)</i>	260169

735E Boom / Ausleger

Model Modell	PLN PLN	Description Bezeichnung	No. Nr.
735E	PLN 12448	Boom Damping System <i>Auslegerdämpfung</i>	265272
735E	PLN 15705 + 15706	Hoist limit switch for loading boom – function hoist up/stick out <i>Hubbegrenzung für Kompaktausleger und Greiferstiel</i>	271406
735E	PLN 13920	Pressure indicator (boom cylinder) with Bargraph display (SENCON) and acoustical warning <i>Bargraph Druck-Anzeige (Hubzylinder) im SENCON mit akustischer Warnung</i>	260182
735E	PLN 11813	Ball valves for hydraulic piping grab open/close and grab rotating <i>Kugelhähne für die Hydraulikleitungen Greifer auf/zu und Greifer drehen</i>	260181
735E	PLN 12222	Floating position for equipment <i>Schwimmstellung für Ausrüstung</i>	271408

1.1 SERVICE & RETROFIT KITS / SERVICE & NACHRÜSTSÄTZE

735E Lights & Travel Alarm / Beleuchtung & Fahralarm

Model Modell	PLN PLN	Description Bezeichnung	No. Nr.
735E	PLN 10747	1 LED headlight mounted on the cab roof heading backwards <i>1 LED Scheinwerfer auf dem Kabinendach nach hinten</i>	259254
735E	PLN 13928	2 LED headlights mounted on the stick: 1 piece on left side, 1 piece on right side <i>2 LED Scheinwerfer am Stiel: je 1 Stück links und 1 Stück rechts</i>	259310
735E	PLN 12637	2 LED headlight mounted on the compact boom <i>2 LED Scheinwerfer am Kompaktausleger</i>	259282
735E	PLN 13930	1 LED headlight mounted on the compact boom upper side <i>1 LED Scheinwerfer am Kompaktausleger oben</i>	259315
735E	PLN 13288	1 LED headlight mounted on the cab roof heading forwards <i>1 LED Scheinwerfer auf dem Kabinendach vorn</i>	259300
735E	PLN 13931	2 LED headlights mounted on the sides of the upper-carriage: 1 piece on left side, 1 piece on right side <i>2 LED Scheinwerfer seitlich auf dem Oberwagen: je 1 Stück links und 1 Stück rechts</i>	259319
735E	PLN 13932	1 LED headlight mounted on the counterweight heading backwards <i>1 LED Scheinwerfer auf dem Gegengewicht nach hinten gerichtet</i>	259323
735E	PLN 10749	2 rotating beacons at rear of machine with intermittent horn for travel and swing <i>2 Rundumleuchten am Heck des Gerätes mit Intervallhupe für Fahren und Drehen</i>	257768
735E	PLN 16500	2 rotating beacons at rear of machine with intermittent horn <i>2 Rundumleuchten am Heck des Gerätes mit Intervallhupe</i>	258261
735E	PLN 10748	1 rotating beacon at the cab <i>1 Rundumleuchte an der Kabine</i>	259259
735E	PLN 5222	Intermittent horn for driving (travel alarm) <i>Intervallhupe für Fahren (Fahralarm)</i>	259241

735E Camera Packages / Kamerapakete

Model Modell	PLN PLN	Description Bezeichnung	No. Nr.
735E	---	---	---

735E Functions / Funktionen

Model Modell	PLN PLN	Description Bezeichnung	No. Nr.
735E	PLN 15319	SENtrack DS (Diesel, E-Series) <i>SENtrack DS (Diesel, E-Serie)</i>	265782

1.1 SERVICE & RETROFIT KITS / SERVICE & NACHRÜSTSÄTZE

817E Service Packages / Inspections Sets / Retrofit Kits Service-Pakete / Inspektionssätze / Nachrüstätze

Service Intervals Serviceintervalle

Operating hours / Betriebsstunden	6000	3
	5500	1
	5000	2
	4500	1
	4000	3
	3500	1
	3000	2
	2500	1
	2000	3
	1500	1
	1000	2
	500	1
	250	A



7,0%
Price Advantage
Preisvorteil

Service Packages Service-Pakete

Model Modell	Emission Standard Abgasnorm	Configuration Ausstattung	A	1	2	3
817E	EU Stage IV / Tier 4f	VF	238770	238772	238773	238774
		HC	238771	238772	238773	238775

Hydraulic Oil Filtration Hydraulikölfiltration

VF: standard HC: HydroClean
VF: Standard HC: HydroClean

Water Separator Wasserabscheider

WA: standard WAH: heatable
WA: Standard WAH: beheizbar

Inspection Sets Inspektionssätze

Model Modell	Emission Standard Abgasnorm	VF WA	VF WAH	HC WA	HC WAH
817E	EU Stage IV / Tier 4f	No. Nr. 238777	No. Nr. 238777	No. Nr. 238776	No. Nr. 238776

20%
Price Advantage
Preisvorteil

1.1 SERVICE & RETROFIT KITS / SERVICE & NACHRÜSTSÄTZE

817E Undercarriage / Unterwagen

Model Modell	PLN PLN	Description Bezeichnung	No. Nr.
817E	PLN 13717	Grading blade light version front, MP17E <i>Schiebeschild leichte Ausführung vorne, MP17E</i>	259305
817E	PLN 13718	Grading blade light version rear, MP17E <i>Schiebeschild leichte Ausführung hinten, MP17E</i>	259306
817E	PLN 13724	Protection for drive train, MP17E <i>Schutz für den Fahrtrieb, MP17E</i>	271413
817E	PLN 13720	Solid rubber tires, 10.00-20 (8 units) <i>Vollgummireifen 10.00-20 (8-fach)</i>	271417

817E Uppercarriage / Oberwagen

Model Modell	PLN PLN	Description Bezeichnung	No. Nr.
817E	PLN 13764	Low temperature package, diesel machine with electric preheating devices <i>Tiefemperatur-Paket, Dieselmachine mit elektrischen Vorheizgeräten</i>	271422
817E	PLN 13766	Electric preheating for hydraulic tank, 230 V, diesel machine <i>Elektr. Hydrauliktankvorwärmung, 230 V für Dieselmachines</i>	271420
817E	PLN 13727	Automatic central lubrication for equipment and slewing ring raceway <i>Automatische Zentralschmierung für Ausrüstung und Drehkranzlaufbahn</i>	271414
817E	PLN 13725	Access steps including tool box <i>Aufstieg mit Werkzeugkasten</i>	255180
817E	PLN 13754	Hand rail at the upper structure, tiltable for transportation, diesel engine (EU Stage III A, IV / Tier 3, 4f) <i>Geländer am Oberwagen, abklappbar für Transport Dieselmachine (EU Stufe III A, IV / Tier 3, 4f)</i>	255217
817E	PLN 13755	Hand rail at the upper structure, tiltable for transportation, electric engine <i>Geländer am Oberwagen, abklappbar für Transport, Elektromachine</i>	255218
817E	PLN 13733	Additional counterweight 0.5 t integrated in counterweight <i>Zusatzballast 0,5 t im Gegengewicht integriert</i>	252248
817E	PLN 10687	Diesel refuelling pump (50 l/min) <i>Diesel-Betankungspumpe (50 l/min)</i>	255219
817E	PLN 13731	Cyclone air pre-cleaner – diesel engine EU Stage V / Tier 4f <i>Zyklon-Vorabscheider – Dieselmotor EU Stufe V / Tier 4f</i>	255220
817E	PLN 14776	SENNEBOGEN HydroClean <i>SENNEBOGEN HydroClean</i>	255221

1.1 SERVICE & RETROFIT KITS / SERVICE & NACHRÜSTSÄTZE

817E Boom / Ausleger

Model Modell	PLN PLN	Description Bezeichnung	No. Nr.
817E	PLN 15808 + 13789 + 13790	K7 materials handling boom - 4.3 m + 3.3 m <i>K7 Arbeitsausrüstung - 4,3 m + 3,3 m</i>	255194
817E	PLN 13771 + 13789 + 13790	K9 materials handling boom - 5.3 m + 3.8 m <i>K9 Arbeitsausrüstung - 5,3 m + 3,8 m</i>	255196
817E	PLN 16198	K7 ULM materials handling boom - 4.3 m + 3.3 m <i>K7 ULM Arbeitsausrüstung - 4,3 m + 3,3 m</i>	255197
817E	PLN 13772	K8 ULM materials handling boom - 4.8 m + 3.3 m <i>K8 ULM Arbeitsausrüstung - 4,8 m + 3,3 m</i>	255198
817E	PLN 13773	K9 ULM materials handling boom - 5.3 m + 3.8 m <i>K9 ULM Arbeitsausrüstung - 5,3 m + 3,8 m</i>	255199
817E	PLN 14427	Pressure indicator (boom cylinder) with Bargraph display (SENCON) and acoustical warning <i>Bargraph Druck-Anzeige (Hubzylinder) im SENCON mit akustischer Warnung</i>	255200
817E	PLN 16397	Pressure indicator (boom cylinder) with Bargraph display in the SENCON and acoustical warning, deactivation possible, bridgeable <i>Bargraph Druck-Anzeige (Hubzylinder) im SENCON mit akustischer Warnung, abschaltbar, überbrückbar</i>	255201
817E	PLN 13781	ULM hydraulics - operate bucket cylinder and standard grab <i>ULM-Hydraulik - Betätigung Löffelzylinder und Standard Greifer</i>	255203
817E	PLN 14647	9 kW Magnet system with hydraulically driven generator (diesel machine) <i>9 kW Magnetanlage mit hydraulisch angetriebenem Generator (nur für Dieselmotoren)</i>	255204
817E	PLN 11813	Ball valves for hydraulic piping grab open/close and grab rotating <i>Kugelhähne für die Hydraulikleitungen Greifer auf/zu und Greifer drehen</i>	260171
817E	PLN 13778 + 13779	Hoist limit switch for grab stick and loading boom <i>Hubbegrenzung für Greiferstiel und Kompaktausleger</i>	254410

817E Lights & Travel Alarm / Beleuchtung & Fahralarm

Model Modell	PLN PLN	Description Bezeichnung	No. Nr.
817E	PLN 13789	2 LED headlights mounted on the stick: 1 piece on left side, 1 piece on right side <i>2 LED Scheinwerfer am Stiel: je 1 Stück links und 1 Stück rechts</i>	255206
817E	PLN 13790	1 LED headlight mounted on the compact boom down side <i>1 LED Scheinwerfer am Kompaktausleger unten</i>	255207
817E	PLN 13791	1 LED headlight mounted on the compact boom upper side <i>1 LED Scheinwerfer am Kompaktausleger oben</i>	255208
817E	PLN 10747	1 LED headlight mounted on the cab roof heading backwards <i>1 LED Scheinwerfer auf dem Kabinendach nach hinten</i>	255209
817E	PLN 13288	1 LED headlight mounted on the cab roof heading forwards <i>1 LED Scheinwerfer auf dem Kabinendach vorn</i>	255210
817E	PLN 13794	1 LED headlight mounted on the uppercarriage right side heading forwards <i>1 LED Scheinwerfer auf dem Oberwagen rechts vorne</i>	255211

1.1 SERVICE & RETROFIT KITS / SERVICE & NACHRÜSTSÄTZE

Model Modell	PLN PLN	Description Bezeichnung	No. Nr.
817E	PLN 13795	2 LED headlights mounted on the sides of the upper-carriage: 1 piece on left side, 1 piece on right side <i>2 LED Scheinwerfer seitlich auf dem Oberwagen: je 1 Stück links und 1 Stück rechts</i>	255212
817E	PLN 13796	1 LED headlight mounted on the counterweight heading backwards <i>1 LED Scheinwerfer auf dem Gegengewicht nach hinten gerichtet</i>	255213
817E	PLN 10749	2 rotating beacons at rear of machine with intermittent horn for travel and swing <i>2 Rundumleuchten am Heck des Gerätes mit Intervallhupe für Fahren und Drehen</i>	255214
817E	PLN 16500	2 rotating beacons at rear of machine with intermittent horn <i>2 Rundumleuchten am Heck des Gerätes mit Intervallhupe</i>	271418
817E	PLN 10748	1 rotating beacon at the cab <i>1 Rundumleuchte an der Kabine</i>	255222
817E	PLN 10751	Protection guard for integrated H4 headlight <i>Schutzgitter für H4 Einbauscheinwerfer</i>	255225
817E	PLN 5222	Intermittent horn for driving (travel alarm) <i>Intervallhupe für Fahren (Fahralarm)</i>	255223
817E	PLN 14683	Intermittent horn for driving (travel alarm), deactivation possible <i>Intervallhupe für Fahren (Fahralarm), abschaltbar</i>	255224

817E Camera Packages / Kamerapakete

Model Modell	PLN PLN	Description Bezeichnung	No. Nr.
817E	PLN 13729	Camera system instead of rear view mirrors <i>Kamerasystem anstelle der Spiegel</i>	254655
817E	PLN 10689	Camera system – add-on camera (1 piece) on the equipment <i>Kamerasystem – Erweiterung mit 1 Kamera an der Ausrüstung</i>	255202

817E Functions / Funktionen

Model Modell	PLN PLN	Description Bezeichnung	No. Nr.
817E	PLN 15319	SENtrack DS (Diesel, E-Series) <i>SENtrack DS (Diesel, E-Serie)</i>	265785

1.1 SERVICE & RETROFIT KITS / SERVICE & NACHRÜSTSÄTZE

818D Service Packages / Inspections Sets

Service-Pakete / Inspektionssätze

Service Intervals Serviceintervalle

Operating hours / Betriebsstunden	6000	3
	5500	1
	5000	2
	4500	1
	4000	3
	3500	1
	3000	2
	2500	1
	2000	3
	1500	1
	1000	2
	500	1
	250	A



7,0%
Price Advantage
Preisvorteil

Service Packages Service-Pakete

Model Modell	Emission Standard Abgasnorm	Configuration Ausstattung	No. Nr.	No. Nr.	No. Nr.	No. Nr.
818D	EU Stage III A / Tier 3	VF WA	164548	180857	180928	181054
		VF WAH	164548	180858	180929	181055
		HC WA	164549	180857	180928	181056
		HC WAH	164549	180858	180929	181057

Hydraulic Oil Filtration Hydraulikölfiltration

VF: standard HC: HydroClean
VF: Standard HC: HydroClean

Water Separator Wasserabscheider

WA: standard WAH: heatable
WA: Standard WAH: beheizbar

Inspection Sets Inspektionssätze

Model Modell	Emission Standard Abgasnorm	No. Nr.	No. Nr.	No. Nr.	No. Nr.
818D	EU Stage III A / Tier 3	162235	162236	162237	162238

20%
Price Advantage
Preisvorteil

1.1 SERVICE & RETROFIT KITS / SERVICE & NACHRÜSTSÄTZE

818E Service Packages / Inspections Sets / Retrofit Kits Service-Pakete / Inspektionssätze / Nachrüstätze

Service Intervals Serviceintervalle

Operating hours / Betriebsstunden	6000	3
	5500	1
	5000	2
	4500	1
	4000	3
	3500	1
	3000	2
	2500	1
	2000	3
	1500	1
	1000	2
	500	1
	250	A



Service Packages Service-Pakete

			A	1	2	3
Model Modell	Emission Standard Abgasnorm	Configuration Ausstattung	No. Nr.	No. Nr.	No. Nr.	No. Nr.
818E	EU Stage III A / Tier 3	VF	180832	180864	180947	180990
		HC	180833	180864	180947	180991
	EU Stage III B / Tier 4i	VF	180832	180863	180946	180988
		HC	180833	180863	180946	180989
	EU Stage IV / Tier 4f	VF	180832	219475	219476	219477
		HC	180833	219475	219476	219478

Hydraulic Oil Filtration Hydraulikölfiltration

VF: standard HC: HydroClean
VF: Standard HC: HydroClean

Water Separator Wasserabscheider

WA: standard WAH: heatable
WA: Standard WAH: beheizbar



Inspection Sets Inspektionssätze

		VF WA	VF WAH	HC WA	HC WAH
Model Modell	Emission Standard Abgasnorm	No. Nr.	No. Nr.	No. Nr.	No. Nr.
818E	EU Stage III A / Tier 3		180487		180488
	EU Stage III B / Tier 4i		180485		180486
	EU Stage IV / Tier 4f		219479		219480

1.1 SERVICE & RETROFIT KITS / SERVICE & NACHRÜSTSÄTZE

818E Undercarriage / Unterwagen

Model Modell	PLN PLN	Description Bezeichnung	No. Nr.
818E	PLN 13717	Grading blade light version front, MP21E (PAH4 required) <i>Schiebeschild leichte Ausführung vorne, MP21E (PAH4 notwendig)</i>	218109
818E	PLN 10622	Air tires 10.00-20 (8 units) <i>Luftreifen 10.00-20 (8-fach)</i>	271424
818E	PLN 10630	Hitch (up to 200 kN pulling force, no vertical load) for wheeled machine <i>Rangierkupplung (bis max. 200 kN Zugkraft, keine Stützlast) für Mobilgerät</i>	260159
818E	PLN 11345	Protection for drive train, MP21E <i>Schutz für den Fahrantrieb, MP21E</i>	259490

818E Uppercarriage / Oberwagen

Model Modell	PLN PLN	Description Bezeichnung	No. Nr.
818E	PLN 10694	Grated step on side of cab with hand rail (bolted) <i>Trittrost neben Kabine mit Geländer (geschraubt)</i>	261187
818E	PLN 12115	Hand rail at the upper structure, tiltable for transportation, diesel engine (EU Stage III A, III B, IV / Tier 3, 4i, 4f) <i>Geländer am Oberwagen, abklappbar für Transport, Dieselmachine (EU Stufe III A, III B, IV / Tier 3, 4i, 4f)</i>	259277
818E	PLN 12116	Hand rail at the upper structure, tiltable for transportation, electric engine <i>Geländer am Oberwagen, abklappbar für Transport, Elektromachine</i>	259278
818E	PLN 12172	Additional counterweight 0.6 t integrated in counterweight <i>Zusatzballast 0,6 t im Gegengewicht integriert</i>	259491
818E	PLN 12463	Additional counterweight 1.5 t + 0.6 t <i>Zusatzballast 1,5 t + 0,6 t</i>	257095
818E	PLN 12799	Low temperature package, diesel machine with electric preheating devices (EU Stage III A / Tier 3) <i>Tiefemperatur-Paket, Dieselmachine mit elektrischen Vorheizgeräten (EU Stufe III A / Tier 3)</i>	271441
818E	PLN 12799	Low temperature package, diesel machine with electric preheating devices (EU Stage IV / Tier 4f) <i>Tiefemperatur-Paket, Dieselmachine mit elektrischen Vorheizgeräten (EU Stufe IV / Tier 4f)</i>	271440
818E	PLN 13281	Electric preheating for hydraulic tank, 230 V, diesel machine (EU Stage III A / Tier 3) <i>Elektr. Hydrauliktankvorwärmung, 230 V für Dieselmachines (EU Stufe III A / Tier 3)</i>	271410
818E	PLN 13281	Electric preheating for hydraulic tank, 230 V, diesel machine (EU Stage IV / Tier 4f) <i>Elektr. Hydrauliktankvorwärmung, 230 V für Dieselmachines (EU Stufe IV / Tier 4f)</i>	271195
818E	PLN 10687	Diesel refuelling pump (50 l/min) <i>Diesel-Betankungspumpe (50 l/min)</i>	255219
818E	PLN 13075	End muffler for tailpipe - EU Stage IV / Tier 4f engines <i>Endrohrschalldämpfer für EU Stufe IV / Tier 4f Motoren</i>	260168

1.1 SERVICE & RETROFIT KITS / SERVICE & NACHRÜSTSÄTZE

Model Modell	PLN PLN	Description Bezeichnung	No. Nr.
818E	PLN 15683	Cyclone air pre-cleaner – diesel engine EU Stage III A / Tier 3 <i>Zyklon-Vorabscheider – Dieselmotor EU Stufe III A / Tier 3</i>	259341
818E	PLN 15684	Cyclone air pre-cleaner – diesel engine EU Stage V / Tier 4f <i>Zyklon-Vorabscheider – Dieselmotor EU Stufe V / Tier 4f Fremdstart (Pluspol)</i>	259342
818E	PLN 11166	Jump start connection (positive pole) <i>Fremdstart (Pluspol)</i>	260169
818E	PLN 10686	SENNEBOGEN HydroClean <i>SENNEBOGEN HydroClean</i>	257100

818E Boom / Ausleger

Model Modell	PLN PLN	Description Bezeichnung	No. Nr.
818E	PLN 11813	Ball valves for hydraulic piping grab open/close and grab rotating <i>Kugelhähne für die Hydraulikleitungen Greifer auf/zu und Greifer drehen Auslegerdämpfung 818E</i>	260171
818E	PLN 13473	Boom damping system 818E <i>Auslegerdämpfung 818E</i>	238382
818E	PLN 11633 + 11634	Hoist limit switch for grab stick and loading boom <i>Hubbegrenzung für Greiferstiel und Kompaktausleger</i>	217397
818E	PLN 13702	Pressure indicator (boom cylinder) with Bargraph display (SENCON) and acoustical warning <i>Bargraph Druck-Anzeige (Hubzylinder) im SENCON mit akustischer Warnung</i>	260172
818E	PLN 14548	Pressure indicator (boom cylinder) with Bargraph display in the SENCON and acoustical warning, deactivation possible, bridgeable <i>Bargraph Druck-Anzeige (Hubzylinder) im SENCON mit akustischer Warnung, abschaltbar, überbrückbar</i>	260174
818E	PLN 10739	9 kW Magnet system with hydraulically driven generator (diesel machine) <i>9 kW Magnetanlage mit hydraulisch angetriebenem Generator (nur für Dieselmotoren)</i>	208393
818E	PLN 14105	15 kW Magnet system with hydraulically driven generator (diesel machine) <i>15 kW Magnetanlage mit hydraulisch angetriebenem Generator (nur für Dieselmotoren)</i>	242584

818E Lights & Travel Alarm / Beleuchtung & Fahralarm

Model Modell	PLN PLN	Description Bezeichnung	No. Nr.
818E	PLN 10747	1 LED headlight mounted on the cab roof heading backwards <i>1 LED Scheinwerfer auf dem Kabinendach nach hinten</i>	259255
818E	PLN 13836	2 LED headlights mounted on the stick: 1 piece on left side, 1 piece on right side <i>2 LED Scheinwerfer am Stiel: je 1 Stück links und 1 Stück rechts</i>	259294
818E	PLN 13837	1 LED headlight mounted on the compact boom down side <i>1 LED Scheinwerfer am Kompaktausleger unten</i>	259295
818E	PLN 13838	1 LED headlight mounted on the compact boom upper side <i>1 LED Scheinwerfer am Kompaktausleger oben</i>	259296
818E	PLN 13288	1 LED headlight mounted on the cab roof heading forwards <i>1 LED Scheinwerfer auf dem Kabinendach vorn</i>	259298

1.1 SERVICE & RETROFIT KITS / SERVICE & NACHRÜSTSÄTZE

Model Modell	PLN PLN	Description Bezeichnung	No. Nr.
818E	PLN 13289	2 LED headlights mounted on the sides of the upper-carriage: 1 piece on left side, 1 piece on right side <i>2 LED Scheinwerfer seitlich auf dem Oberwagen: je 1 Stück links und 1 Stück rechts</i>	259302
818E	PLN 13290	1 LED headlight mounted on the counterweight heading backwards <i>1 LED Scheinwerfer auf dem Gegengewicht nach hinten gerichtet</i>	259303
818E	PLN 10751	Protection guard for integrated H4 headlight <i>Schutzgitter für H4 Einbauscheinwerfer</i>	259265
818E	PLN 10748	1 rotating beacon at the cab <i>1 Rundumleuchte an der Kabine</i>	256761
818E	PLN 10749	2 rotating beacons at rear of machine with intermittent horn for travel and swing <i>2 Rundumleuchten am Heck des Gerätes mit Intervallhupe für Fahren und Drehen</i>	256225
818E	PLN 16500	2 rotating beacons at rear of machine with intermittent horn <i>2 Rundumleuchten am Heck des Gerätes mit Intervallhupe</i>	271443
818E	PLN 5222	Intermittent horn for driving (travel alarm) <i>Intervallhupe für Fahren (Fahralarm)</i>	256762
818E	PLN 14683	Intermittent horn for driving (travel alarm), deactivation possible <i>Intervallhupe für Fahren (Fahralarm), abschaltbar</i>	259332

818E Camera Packages / Kamerapakete

Model Modell	PLN PLN	Description Bezeichnung	No. Nr.
818E	PLN 14661	Camera system – view under cabin <i>Kamerasystem für Kabinenunterbodenüberwachung</i>	260160
818E	PLN 10689	Camera system – add-on camera (1 piece) on the equipment <i>Kamerasystem – Erweiterung mit 1 Kamera an der Ausrüstung</i>	255202

818E Functions / Funktionen

Model Modell	PLN PLN	Description Bezeichnung	No. Nr.
818E	PLN 10613	Joystick-steering (only wheeled machines) <i>Joystick-Lenkung anstelle Lenkradlenkung</i>	254105
818E	PLN 15319	SENtrack DS (Diesel, E-Series) for SENCON 1 <i>SENtrack DS (Diesel, E-Serie) für SENCON 1</i>	265784

1.1 SERVICE & RETROFIT KITS / SERVICE & NACHRÜSTSÄTZE

821E

Service Packages / Inspections Sets / Retrofit Kits
 Service-Pakete / Inspektionssätze / Nachrüstätze

Service Intervals
 Serviceintervalle

6000	3
5500	1
5000	2
4500	1
4000	3
3500	1
3000	2
2500	1
2000	3
1500	1
1000	2
500	1
250	A

Operating hours / Betriebsstunden



Service Packages
 Service-Pakete

			A	1	2	3
Model Modell	Emission Standard Abgasnorm	Configuration Ausstattung	No. Nr.	No. Nr.	No. Nr.	No. Nr.
821E	EU Stage III A / Tier 3	VF	180832	180864	180947	180990
		HC	180833	180864	180947	180991
	EU Stage III B / Tier 4i	VF	180832	180863	180946	180988
		HC	180833	180863	180946	180989
	EU Stage IV / Tier 4f	VF	180832	219475	219476	219477
		HC	180833	219475	219476	219478

Hydraulic Oil Filtration
 Hydraulikölfiltration

VF: standard HC: HydroClean
 VF: Standard HC: HydroClean

Water Separator
 Wasserabscheider

WA: standard WAH: heatable
 WA: Standard WAH: beheizbar



Inspection Sets
 Inspektionssätze

		VF WA	VF WAH	HC WA	HC WAH
Model Modell	Emission Standard Abgasnorm	No. Nr.	No. Nr.	No. Nr.	No. Nr.
821E	EU Stage III A / Tier 3		180487		180488
	EU Stage III B / Tier 4i		180485		180486
	EU Stage IV / Tier 4f		219479		219480

1.1 SERVICE & RETROFIT KITS / SERVICE & NACHRÜSTSÄTZE

821E Undercarriage / Unterwagen

Model Modell	PLN PLN	Description Bezeichnung	No. Nr.
821E	PLN 13464	Grading blade light version front, MP21E (PAH4 required) <i>Schiebeschild leichte Ausführung vorne, MP21E (PAH4 notwendig)</i>	218109
821E	PLN 10622	Air tires 10.00-20 (8 units) <i>Luftreifen 10.00-20 (8-fach)</i>	271424
821E	PLN 10630	Hitch (up to 200 kN pulling force, no vertical load) for wheeled machine <i>Rangierkupplung (bis max. 200 kN Zugkraft, keine Stützlast) für Mobilgerät</i>	260159
821E	PLN 11345	Protection for drive train, MP21E <i>Schutz für den Fahrtrieb, MP21E</i>	259490
821E	PLN 11015	Protection for drive train, MP26E <i>Schutz für den Fahrtrieb, MP26E</i>	260176

821E Uppercarriage / Oberwagen

Model Modell	PLN PLN	Description Bezeichnung	No. Nr.
821E	PLN 12115	Hand rail at the upper structure, tiltable for transportation, diesel engine (EU Stage III A, III B, IV / Tier 3, 4i, 4f) <i>Geländer am Oberwagen, abklappbar für Transport, Dieselmachine (EU Stufe III A, III B, IV / Tier 3, 4i, 4f)</i>	259277
821E	PLN 12116	Hand rail at the upper structure, tiltable for transportation, electric engine <i>Geländer am Oberwagen, abklappbar für Transport, Elektromachine</i>	259278
821E	PLN 10694	Grated step on side of cab with hand rail (bolted) <i>Trittrost neben Kabine mit Geländer (geschraubt)</i>	261187
821E	PLN 12799	Low temperature package, diesel machine with electric preheating devices (EU Stage III A / Tier 3) <i>Tieftemperatur-Paket, Dieselmachine mit elektrischen Vorheizgeräten (EU Stufe III A / Tier 3)</i>	271441
821E	PLN 12799	Low temperature package, diesel machine with electric preheating devices (EU Stage IV / Tier 4f) <i>Tieftemperatur-Paket, Dieselmachine mit elektrischen Vorheizgeräten (EU Stufe IV / Tier 4f)</i>	271440
821E	PLN 13281	Electric preheating for hydraulic tank, 230 V, diesel machine (EU Stage III A / Tier 3) <i>Elektr. Hydrauliktankvorwärmung, 230 V für Dieselmachines (EU Stufe III A / Tier 3)</i>	271410
821E	PLN 13281	Electric preheating for hydraulic tank, 230 V, diesel machine (EU Stage IV / Tier 4f) <i>Elektr. Hydrauliktankvorwärmung, 230 V für Dieselmachines (EU Stufe IV / Tier 4f)</i>	271195
821E	PLN 11664	Additional counterweight 1.5 t on counterweight <i>Zusatzballast 1,5 t am Gegengewicht</i>	256756
821E	PLN 10687	Diesel refuelling pump (50 l/min) <i>Diesel-Betankungspumpe (50 l/min)</i>	255219
821E	PLN 13075	End muffler for tailpipe - EU Stage IV / Tier 4f engines <i>Endrohrschalldämpfer für EU Stufe IV / Tier 4f Motoren</i>	260168

1.1 SERVICE & RETROFIT KITS / SERVICE & NACHRÜSTSÄTZE

Model Modell	PLN PLN	Description Bezeichnung	No. Nr.
821E	PLN 15683	Cyclone air pre-cleaner – diesel engine EU Stage III A / Tier 3 <i>Zyklon-Vorabscheider – Dieselmotor EU Stufe III A / Tier 3</i>	259341
821E	PLN 15684	Cyclone air pre-cleaner – diesel engine EU Stage V / Tier 4f <i>Zyklon-Vorabscheider – Dieselmotor EU Stufe V / Tier 4f</i>	259342
821E	PLN 11166	Jump start connection (positive pole) <i>Fremdstart (Pluspol)</i>	260169
821E	PLN 10686	SENNEBOGEN HydroClean <i>SENNEBOGEN HydroClean</i>	257100

821E Boom / Ausleger

Model Modell	PLN PLN	Description Bezeichnung	No. Nr.
821E	PLN 11665	ULM hydraulics – option hammer + depressurized return line <i>ULM-Hydraulik – Option Hammer + drucklose Rücklaufleitung</i>	259275
821E	PLN 11813	Ball valves for hydraulic piping grab open/close and grab rotating <i>Kugelhähne für die Hydraulikleitungen Greifer auf/zu und Greifer drehen</i>	260171
821E	PLN 13474	Boom damping system 821E <i>Auslegerdämpfung 821E</i>	238383
821E	PLN 10728 + 10729	Hoist limit switch for grab stick and loading boom <i>Hubbegrenzung für Greiferstiel und Kompaktausleger</i>	217397
821E	PLN 13702	Pressure indicator (boom cylinder) with Bargraph display (SENCON) and acoustical warning <i>Bargraph Druck-Anzeige (Hubzylinder) im SENCON mit akustischer Warnung</i>	256760
821E	PLN 14548	Pressure indicator (boom cylinder) with Bargraph display in the SENCON and acoustical warning, deactivation possible, bridgeable <i>Bargraph Druck-Anzeige (Hubzylinder) im SENCON mit akustischer Warnung, abschaltbar, überbrückbar</i>	260174
821E	PLN 10739	9 kW Magnet system with hydraulically driven generator (diesel machine) <i>9 kW Magnetanlage mit hydraulisch angetriebenem Generator (nur für Dieselmotoren)</i>	208393
821E	PLN 10740	15 kW Magnet system with hydraulically driven generator (diesel machine) <i>15 kW Magnetanlage mit hydraulisch angetriebenem Generator (nur für Dieselmotoren)</i>	242584

821E Lights & Travel Alarm / Beleuchtung & Fahralarm

Model Modell	PLN PLN	Description Bezeichnung	No. Nr.
821E	PLN 13288	1 LED headlight mounted on the cab roof heading forwards <i>1 LED Scheinwerfer auf dem Kabinendach vorn</i>	259298
821E	PLN 10747	1 LED headlight mounted on the cab roof heading backwards <i>1 LED Scheinwerfer auf dem Kabinendach nach hinten</i>	259255
821E	PLN 13285	2 LED headlights mounted on the stick: 1 piece on left side, 1 piece on right side <i>2 LED Scheinwerfer am Stiel: je 1 Stück links und 1 Stück rechts</i>	259294
821E	PLN 13286	1 LED headlight mounted on the compact boom down side <i>1 LED Scheinwerfer am Kompaktausleger unten</i>	259295
821E	PLN 13287	1 LED headlight mounted on the compact boom upper side <i>1 LED Scheinwerfer am Kompaktausleger oben</i>	259296

1.1 SERVICE & RETROFIT KITS / SERVICE & NACHRÜSTSÄTZE

Model Modell	PLN PLN	Description Bezeichnung	No. Nr.
821E	PLN 13289	2 LED headlights mounted on the sides of the upper-carriage: 1 piece on left side, 1 piece on right side <i>2 LED Scheinwerfer seitlich auf dem Oberwagen: je 1 Stück links und 1 Stück rechts</i>	259302
821E	PLN 13290	1 LED headlight mounted on the counterweight heading backwards <i>1 LED Scheinwerfer auf dem Gegengewicht nach hinten gerichtet</i>	259303
821E	PLN 10751	Protection guard for integrated H4 headlight <i>Schutzgitter für H4 Einbauscheinwerfer</i>	259265
821E	PLN 10748	1 rotating beacon at the cab <i>1 Rundumleuchte an der Kabine</i>	256761
821E	PLN 10749	2 rotating beacons at rear of machine with intermittent horn for travel and swing <i>2 Rundumleuchten am Heck des Gerätes mit Intervallhupe für Fahren und Drehen</i>	256312
821E	PLN 16500	2 rotating beacons at rear of machine with intermittent horn <i>2 Rundumleuchten am Heck des Gerätes mit Intervallhupe</i>	271443
821E	PLN 5222	Intermittent horn for driving (travel alarm) <i>Intervallhupe für Fahren (Fahralarm)</i>	256762
821E	PLN 14683	Intermittent horn for driving (travel alarm), deactivation possible <i>Intervallhupe für Fahren (Fahralarm), abschaltbar</i>	259332

821E Camera Packages / Kamerapakete

Model Modell	PLN PLN	Description Bezeichnung	No. Nr.
821E	PLN 14661	Camera system – view under cabin <i>Kamerasystem für Kabinenunterbodenüberwachung</i>	260160
821E	PLN 10689	Camera system – add-on camera (1 piece) on the equipment <i>Kamerasystem – Erweiterung mit 1 Kamera an der Ausrüstung</i>	255202

821E Functions / Funktionen

Model Modell	PLN PLN	Description Bezeichnung	No. Nr.
821E	PLN 10613	Joystick-steering (only wheeled machines) <i>Joystick-Lenkung anstelle Lenkradlenkung</i>	254105
821E	PLN 15319	SENtrack DS (Diesel, E-Series) for SENCON 1 <i>SENtrack DS (Diesel, E-Serie) für SENCON 1</i>	265784

1.1 SERVICE & RETROFIT KITS / SERVICE & NACHRÜSTSÄTZE

825D

Service Packages / Inspections Sets / Retrofit Kits
 Service-Pakete / Inspektionssätze / Nachrüstätze

Service Intervals
 Serviceintervalle

6000	3
5500	1
5000	2
4500	1
4000	3
3500	1
3000	2
2500	1
2000	3
1500	1
1000	2
500	1
250	A

Operating hours / Betriebsstunden



7,0%
 Price Advantage
 Preisvorteil

Service Packages Service-Pakete		A	1	2	3	
Model Modell	Emission Standard Abgasnorm	Configuration Ausstattung	No. Nr.	No. Nr.	No. Nr.	No. Nr.
825D	EU Stage III A / Tier 3	VF WA	164550	180857	180932	181062
		VF WAH	164550	180858	180933	181063
		HC WA	164551	180857	180932	181064
		HC WAH	164551	180858	180933	181065

Hydraulic Oil Filtration
 Hydraulikölfiltration

VF: standard HC: HydroClean
 VF: Standard HC: HydroClean

Water Separator
 Wasserabscheider

WA: standard WAH: heatable
 WA: Standard WAH: beheizbar

20%
 Price Advantage
 Preisvorteil

Inspection Sets Inspektionssätze		VF WA	VF WAH	HC WA	HC WAH
Model Modell	Emission Standard Abgasnorm	No. Nr.	No. Nr.	No. Nr.	No. Nr.
825D	EU Stage III A / Tier 3	162243	162244	162245	162246

1.1 SERVICE & RETROFIT KITS / SERVICE & NACHRÜSTSÄTZE

825D Undercarriage / Unterwagen

Model Modell	PLN PLN	Description Bezeichnung	No. Nr.
825D	---	---	---

825D Uppercarriage / Oberwagen

Model Modell	PLN PLN	Description Bezeichnung	No. Nr.
825D	PLN	Hand rail at the upper structure, to screw off for transport	198514
830D	4614	Geländer am Oberwagen, abschraubbar für Transport	

825D Boom / Ausleger

Model Modell	PLN PLN	Description Bezeichnung	No. Nr.
825D	PLN	Ball valves for hydraulic piping grab open/close and grab rotating	260181
830D	2864	Kugelhähne für die Hydraulikleitungen Greifer auf/zu und Greifer drehen	

825D Lights & Travel Alarm / Beleuchtung & Fahralarm

Model Modell	PLN PLN	Description Bezeichnung	No. Nr.
825D	---	---	---

825D Camera Packages / Kamerapakete

Model Modell	PLN PLN	Description Bezeichnung	No. Nr.
825D	PLN	Camera system – view under cabin	260160
830D	14661	Kamerasystem für Kabinenunterbodenüberwachung	
825D	PLN	Camera system – add-on camera (1 piece)	255202
830D	7475	Kamerasystem – Erweiterung mit 1 Kamera	

825D Functions / Funktionen

Model Modell	PLN PLN	Description Bezeichnung	No. Nr.
825D	---	---	---

1.1 SERVICE & RETROFIT KITS / SERVICE & NACHRÜSTSÄTZE

825E Service Packages / Inspections Sets / Retrofit Kits

Service-Pakete / Inspektionssätze / Nachrüstätze

Service Intervals
Serviceintervalle

6000	3
5500	1
5000	2
4500	1
4000	3
3500	1
3000	2
2500	1
2000	3
1500	1
1000	2
500	1
250	A



Service Packages
Service-Pakete

			A	1	2	3
Model Modell	Emission Standard Abgasnorm	Configuration Ausstattung	No. Nr.	No. Nr.	No. Nr.	No. Nr.
825E	EU Stage III A / Tier 3	VF	180836	234009	234010	234011
		HC	180837	234009	234010	234012
	EU Stage IV / Tier 4f	VF	180836	198390	198391	198392
		HC	180837	198390	198391	198393
	EU Stage V / Tier 4f	VF	247949	247947	247946	247945
		HC	247948	247947	247946	247944

Hydraulic Oil Filtration
Hydraulikölfiltration

VF: standard HC: HydroClean
VF: Standard HC: HydroClean



Inspection Sets
Inspektionssätze

		VF WA	VF WAH	HC WA	HC WAH
Model Modell	Emission Standard Abgasnorm	No. Nr.	No. Nr.	No. Nr.	No. Nr.
825E	EU Stage III A / Tier 3		234013		234014
	EU Stage IV / Tier 4f		198394		198395
	EU Stage V / Tier 4f		247943		247942

Water Separator
Wasserabscheider

WA: standard WAH: heatable
WA: Standard WAH: beheizbar

1.1 SERVICE & RETROFIT KITS / SERVICE & NACHRÜSTSÄTZE

825E Undercarriage / Unterwagen

Model Modell	PLN PLN	Description Bezeichnung	No. Nr.
825E	PLN 13881	Grading Blade front, MP26E <i>Planierschild vorne, MP26E</i>	263338
825E	PLN 10622	Air tires 10.00-20 (8 units) <i>Luftreifen 10.00-20 (8-fach)</i>	271424
825E	PLN 13894	Hitch (up to 200 kN pulling force, no vertical load) for wheeled machine <i>Rangierkupplung (bis max. 200 kN Zugkraft, keine Stützlast) für Mobilgerät</i>	260159
825E	PLN 15708	Preperation for customer trailer coupling, for MP26 <i>Vorbereitung Anbau kundenseitige Anhängerkupplung, für MP26</i>	260177
825E	PLN 11015 / 14086	Protection for drive train, MP26E / MP28E HDS <i>Schutz für den Fahrantrieb, MP26E / MP28E HDS</i>	260176
825E	PLN 8354	Undercarriage counterweight 2 x 4.0 t for R 35/340 <i>Unterwagenballast 2 x 4,0 t für R 35/340</i>	271505

825E Uppercarriage / Oberwagen

Model Modell	PLN PLN	Description Bezeichnung	No. Nr.
825E	PLN 13896	Hand rail at the upper structure, tiltable for transportation, diesel engine (EU Stage III A, V / Tier 3, 4f) <i>Geländer am Oberwagen, abklappbar für Transport Dieselmachine (EU Stufe III A, V / Tier 3, 4f)</i>	259307
825E	PLN 13896	Hand rail at the upper structure, tiltable for transportation, diesel engine (EU Stage IV / Tier 4f) <i>Geländer am Oberwagen, abklappbar für Transport Dieselmachine (EU Stufe IV / Tier 4f)</i>	259417
825E	PLN 13897	Hand rail at the upper structure, tiltable for transportation, electric engine <i>Geländer am Oberwagen, abklappbar für Transport, Elektromachine</i>	259308
825E	PLN 10694	Grated step on side of cab with hand rail (bolted) <i>Trittrost neben Kabine mit Geländer (geschraubt)</i>	261187
825E	PLN 7516	Additional counterweight 1.1 t <i>Zusatzballast 1,1 t im Gegengewicht</i>	260178
825E	PLN 13908	Low temperature package, diesel machine with electric preheating devices <i>Tieftemperatur-Paket, Dieselmachine mit elektrischen Vorheizgeräten</i>	271507
825E	PLN 13910	Electric preheating for hydraulic tank, 230 V, diesel machine (EU Stage III A / Tier 3) <i>Elektr. Hydrauliktankvorwärmung, 230 V für Dieselmachines (EU Stufe III A / Tier 3)</i>	271509
825E	PLN 13910	Electric preheating for hydraulic tank, 230 V, diesel machine (EU Stage IV / Tier 4f) <i>Elektr. Hydrauliktankvorwärmung, 230 V für Dieselmachines (EU Stufe IV / Tier 4f)</i>	271510
825E	PLN 10687	Diesel refuelling pump (50 l/min) (EU Stage III A, V / Tier 3, 4f) <i>Diesel-Betankungspumpe (50 l/min) (EU Stufe III A, V / Tier 3, 4f)</i>	260195
825E	PLN 10687	Diesel refuelling pump (50 l/min) (EU Stage IV / Tier 4f) <i>Diesel-Betankungspumpe (50 l/min) (EU Stufe IV / Tier 4f)</i>	250691
825E	PLN 16056	Cyclone air pre-cleaner – diesel engine EU Stage III A, V / Tier 3, 4f <i>Zyklon-Vorabscheider – Dieselmotor EU Stufe III A, V / Tier 3, 4f</i>	259351
825E	PLN 11166	Jump start connection (positive pole) <i>Fremdstart (Pluspol)</i>	260169
825E	PLN 13912	SENNEBOGEN HydroClean <i>SENNEBOGEN HydroClean</i>	260179

1.1 SERVICE & RETROFIT KITS / SERVICE & NACHRÜSTSÄTZE

825E Boom / Ausleger

Model Modell	PLN PLN	Description Bezeichnung	No. Nr.
825E	PLN 11813	Ball valves for hydraulic piping grab open/close and grab rotating <i>Kugelhähne für die Hydraulikleitungen Greifer auf/zu und Greifer drehen</i>	260181
825E	PLN 13937	Boom damping system 825E <i>Auslegerdämpfung 825E</i>	238384
825E	PLN 13918 + 13919	Hoist limit switch for grab stick and loading boom <i>Hubbegrenzung für Greiferstiel und Kompaktausleger</i>	217397
825E	PLN 13920	Pressure indicator (boom cylinder) with Bargraph display (SENCON) and acoustical warning <i>Bargraph Druck-Anzeige (Hubzylinder) im SENCON mit akustischer Warnung</i>	260182
825E	PLN 14549	Pressure indicator (boom cylinder) with Bargraph display in the SENCON and acoustical warning, deactivation possible, bridgeable <i>Bargraph Druck-Anzeige (Hubzylinder) im SENCON mit akustischer Warnung, abschaltbar, überbrückbar</i>	260183
825E	PLN 15658	Protection for piston rod of lifting cylinders (825) <i>Kolbenstangenschutz an Hubzylindern (825)</i>	260249
825E	PLN 14902	15 kW Magnet system with hydraulically driven generator (diesel machine) – for already existing magnet system preparation <i>15 kW Magnetanlage mit hydraulisch angetriebenem Generator (Dieselmaschinen) – für bereits vorhandene Magnetanlagenvorbereitung</i>	256310
825E	PLN 14902	15 kW Magnet system with hydraulically driven generator (diesel machine) – without magnet system preparation <i>15 kW Magnetanlage mit hydraulisch angetriebenem Generator (Dieselmaschinen) – ohne Magnetanlagenvorbereitung</i>	259337

825E Lights & Travel Alarm / Beleuchtung & Fahralarm

Model Modell	PLN PLN	Description Bezeichnung	No. Nr.
825E	PLN 13288	1 LED headlight mounted on the cab roof heading forwards <i>1 LED Scheinwerfer auf dem Kabinendach vorn</i>	259301
825E	PLN 10747	1 LED headlight mounted on the cab roof heading backwards <i>1 LED Scheinwerfer auf dem Kabinendach nach hinten</i>	259255
825E	PLN 13928	2 LED headlights mounted on the stick: 1 piece on left side, 1 piece on right side <i>2 LED Scheinwerfer am Stiel: je 1 Stück links und 1 Stück rechts</i>	259311
825E	PLN 13929	1 LED headlight mounted on the compact boom down side <i>1 LED Scheinwerfer am Kompaktausleger unten</i>	259313
825E	PLN 13930	1 LED headlight mounted on the compact boom upper side <i>1 LED Scheinwerfer am Kompaktausleger oben</i>	259316
825E	PLN 13931	2 LED headlights mounted on the sides of the upper-carriage: 1 piece on left side, 1 piece on right side <i>2 LED Scheinwerfer seitlich auf dem Oberwagen: je 1 Stück links und 1 Stück rechts</i>	259302
825E	PLN 13932	1 LED headlight mounted on the counterweight heading backwards <i>1 LED Scheinwerfer auf dem Gegengewicht nach hinten gerichtet</i>	259324
825E	PLN 10751	Protection guard for integrated H4 headlight <i>Schutzgitter für H4 Einbauscheinwerfer</i>	259265

1.1 SERVICE & RETROFIT KITS / SERVICE & NACHRÜSTSÄTZE

Model Modell	PLN PLN	Description Bezeichnung	No. Nr.
825E	PLN 10748	1 rotating beacon at the cab <i>1 Rundumleuchte an der Kabine</i>	259259
825E	PLN 10749	2 rotating beacons at rear of machine with intermittent horn for travel and swing <i>2 Rundumleuchten am Heck des Gerätes mit Intervallhupe für Fahren und Drehen</i>	259263
825E	PLN 16500	2 rotating beacons at rear of machine with intermittent horn <i>2 Rundumleuchten am Heck des Gerätes mit Intervallhupe</i>	258261
825E	PLN 5222	Intermittent horn for driving (travel alarm) <i>Intervallhupe für Fahren (Fahralarm)</i>	259241
825E	PLN 14683	Intermittent horn for driving (travel alarm), deactivation possible <i>Intervallhupe für Fahren (Fahralarm), abschaltbar</i>	259332

825E Camera Packages / Kamerapakete

Model Modell	PLN PLN	Description Bezeichnung	No. Nr.
825E	PLN 14661	Camera system – view under cabin <i>Kamerasystem für Kabinenunterbodenüberwachung</i>	260160
825E	PLN 10689	Camera system – add-on camera (1 piece) on the equipment <i>Kamerasystem – Erweiterung mit 1 Kamera an der Ausrüstung</i>	255202

825E Functions / Funktionen

Model Modell	PLN PLN	Description Bezeichnung	No. Nr.
825E	PLN 15319	SENtrack DS (Diesel, E-Series) for SENCON 1 <i>SENtrack DS (Diesel, E-Serie) für SENCON 1</i>	265783
825E	PLN 15319	SENtrack DS (Diesel, E-Series) for SENCON 2 <i>SENtrack DS (Diesel, E-Serie) für SENCON 2</i>	265782

1.1 SERVICE & RETROFIT KITS / SERVICE & NACHRÜSTSÄTZE

830D Service Packages / Inspections Sets / Retrofit Kits* Service-Pakete / Inspektionssätze / Nachrüstätze*

Service Intervals Serviceintervalle

Operating hours / Betriebsstunden	6000	3
	5500	1
	5000	2
	4500	1
	4000	3
	3500	1
	3000	2
	2500	1
	2000	3
	1500	1
	1000	2
	500	1
	250	A



7,0%
Price Advantage
Preisvorteil

Service Packages Service-Pakete		A	1	2	3	
Model Modell	Emission Standard Abgasnorm	Configuration Ausstattung	No. Nr.	No. Nr.	No. Nr.	No. Nr.
830D	EU Stage III A / Tier 3	VF WA	164550	180857	180932	181062
		VF WAH	164550	180858	180933	181063
		HC WA	164551	180857	180932	181064
		HC WAH	164551	180858	180933	181065

Hydraulic Oil Filtration Hydraulikölfiltration

VF: standard HC: HydroClean
VF: Standard HC: HydroClean

Water Separator Wasserabscheider

WA: standard WAH: heatable
WA: Standard WAH: beheizbar

20%
Price Advantage
Preisvorteil

Inspection Sets Inspektionssätze		VF WA	VF WAH	HC WA	HC WAH
Model Modell	Emission Standard Abgasnorm	No. Nr.	No. Nr.	No. Nr.	No. Nr.
830D	EU Stage III A / Tier 3	162243	162244	162245	162246

*) Please find the available Retrofit Kits at 825D.
*) Die verfügbaren Nachrüstätze können beim 825D eingesehen werden.

1.1 SERVICE & RETROFIT KITS / SERVICE & NACHRÜSTSÄTZE

830E Service Packages / Inspections Sets / Retrofit Kits Service-Pakete / Inspektionssätze / Nachrüstätze

Service Intervals Serviceintervalle

Operating hours / Betriebsstunden	6000	3
	5500	1
	5000	2
	4500	1
	4000	3
	3500	1
	3000	2
	2500	1
	2000	3
	1500	1
	1000	2
	500	1
	250	A



7,0%
Price Advantage
Preisvorteil

Service Packages Service-Pakete

Model Modell	Emission Standard Abgasnorm	Configuration Ausstattung	No. Nr.	No. Nr.	No. Nr.	No. Nr.
830E	EU Stage III A / Tier 3	VF	180836	234009	234010	234011
		HC	180837	234009	234010	234012
	EU Stage III B / Tier 4i up to / bis 830.x.2148	VF	180836	201820	201821	201822
		HC	180837	201820	201821	201823
	EU Stage III B / Tier 4i from / ab 830.x.2149	VF	180836	180865	180948	180992
		HC	180837	180865	180948	180993
	EU Stage IV / Tier 4f	VF	180836	198390	198391	198392
		HC	180837	198390	198391	198393
	EU Stage V / Tier 4f	VF	247949	247947	247946	247945
		HC	247948	247947	247946	247944

Hydraulic Oil Filtration Hydraulikölfiltration

VF: standard HC: HydroClean
VF: Standard HC: HydroClean

Water Separator Wasserabscheider

WA: standard WAH: heatable
WA: Standard WAH: beheizbar

Inspection Sets Inspektionssätze

Model Modell	Emission Standard Abgasnorm	No. Nr.	No. Nr.	No. Nr.	No. Nr.
830E	EU Stage III A / Tier 3	VF	180836	234009	234010
		WA	180836	234009	234010
		VF	180837	201820	201821
		WAH	180837	201820	201821
		HC	180837	201820	201821
EU Stage III B / Tier 4i up to / bis 830.x.2148	VF	180836	201820	201821	
	WA	180836	201820	201821	
EU Stage III B / Tier 4i from / ab 830.x.2149	VF	180836	180865	180948	
	WA	180836	180865	180948	
EU Stage IV / Tier 4f	VF	180836	198390	198391	
	WA	180836	198390	198391	
EU Stage V / Tier 4f	VF	247949	247947	247946	
	WA	247948	247947	247946	

20%
Price Advantage
Preisvorteil

1.1 SERVICE & RETROFIT KITS / SERVICE & NACHRÜSTSÄTZE

830E Undercarriage / Unterwagen

Model Modell	PLN PLN	Description Bezeichnung	No. Nr.
830E	PLN 10387	Air tires 12.00-20 (8 units) for MP30E <i>Luftreifen 12.00-20 (8-fach) für MP30E</i>	271516
830E	PLN 12384	Solid rubber tires 12.00-24 (8 units)for MP41 <i>Vollgummireifen 12.00-24 (8-fach) für MP41</i>	271520
830E	PLN 12514	Air tires 16.00-25, 4 units for MP34, MP38-HDS <i>Luftreifen 16.00-25, 4-fach für MP34, MP38-HDS</i>	271521
830E	PLN 11421	Single air tires 650/65 R 25 (4 units), Bridgestone VTS for MP38-T <i>Single Luftreifen 650/65 R 25 (4-fach), Bridgestone VTS für MP38-T</i>	271522
830E	PLN 13894	Hitch (up to 200 kN pulling force, no vertical load) for wheeled machine <i>Rangierkupplung (bis max. 200 kN Zugkraft, keine Stützlast) für Mobilgerät</i>	260159
830E	PLN10391/ 12389	Protection for drive train, MP30E / MP41 <i>Schutz für den Fahrtrieb, MP30E / MP41</i>	260176
830E	PLN 10436	Protection for drive train, MP38-T <i>Schutz für den Fahrtrieb, MP38-T</i>	271511
830E	PLN 16725	Protection for drive train, MP38-HDS <i>Schutz für den Fahrtrieb, MP38-HDS</i>	271515

830E Uppercarriage / Oberwagen

Model Modell	PLN PLN	Description Bezeichnung	No. Nr.
830E	PLN 10346	Handrail at the upper structure, to screw off for transportation, diesel engine (EU Stage III A, IV / Tier 3, 4f) <i>Geländer am Oberwagen, abschraubbar für Transport, Dieselmachine (EU Stufe III A, IV / Tier 3, 4f)</i>	178934
830E	PLN 14178	Hand rail at the upper structure for diesel machines, tiltable for transportation (EU Stage III A, V / Tier 3, 4f) <i>Geländer am Oberwagen für Dieselmachines, abklappbar für Transport (EU Stufe III A, V / Tier 3, 4f)</i>	259327
830E	PLN 14179	Hand rail at the upper structure for electric machines, tiltable for transportation <i>Geländer am Oberwagen für Elektromachines, abklappbar für Transport</i>	259328
830E	PLN 12804	Low temperature package, diesel machine with electric preheating devices <i>Tieftemperatur-Paket, Dieselmachine mit elektrischen Vorheizgeräten</i>	271507
830E	PLN 10517	Electric preheating for hydraulic tank, 230 V, diesel machine (EU Stage III A / Tier 3) <i>Elektr. Hydrauliktankvorwärmung, 230 V für Dieselmachines (EU Stufe III A / Tier 3)</i>	271509
830E	PLN 10517	Electric preheating for hydraulic tank, 230 V, diesel machine (EU Stage IV / Tier 4f) <i>Elektr. Hydrauliktankvorwärmung, 230 V für Dieselmachines (EU Stufe IV / Tier 4f)</i>	271510
830E	PLN 10687	Diesel refuelling pump (50 l/min) <i>Diesel-Betankungspumpe (50 l/min)</i>	260195
830E	PLN 10686	SENNEBOGEN Hydro Clean <i>SENNEBOGEN Hydro Clean</i>	265958
830E	PLN 16056	Cyclone air pre-cleaner – diesel engine EU Stage III A, V / Tier 3, 4f <i>Zyklon-Vorabscheider – Dieselmotor EU Stufe III A, V / Tier 3, 4f</i>	259351
830E	PLN 11166	Jump start connection (positive pole) <i>Fremdstart (Pluspol)</i>	260169

1.1 SERVICE & RETROFIT KITS / SERVICE & NACHRÜSTSÄTZE

830E Boom / Ausleger

Model Modell	PLN PLN	Description Bezeichnung	No. Nr.
830E	PLN 13626	Boom damping system 830E <i>Auslegerdämpfung 830E</i>	238385
830E	PLN 10544 + 10545	Hoist limit switch for grab stick and loading boom <i>Hubbegrenzung für Greiferstiel und Kompaktausleger</i>	271523
830E	PLN 13920	Pressure indicator (boom cylinder) with Bargraph display (SENCON) and acoustical warning <i>Bargraph Druck-Anzeige (Hubzylinder) im SENCON mit akustischer Warnung</i>	260182
830E	PLN 14549	Pressure indicator (boom cylinder) with Bargraph display in the SENCON and acoustical warning, deactivation possible, bridgeable <i>Bargraph Druck-Anzeige (Hubzylinder) im SENCON mit akustischer Warnung, abschaltbar, überbrückbar</i>	260183
830E	PLN 15195	Protection for piston rod of lifting cylinders <i>Kolbenstangenschutz an Hubzylindern</i>	271512
830E	PLN 15196	Protection for piston rod of stick cylinders <i>Kolbenstangenschutz für Stielzylinder</i>	271514
830E	PLN 15196	Protection for piston rod of stick cylinders for height-extended cabins <i>Kolbenstangenschutz für Stielzylinder für erhöhte Kabinen</i>	271513
830E	PLN 13863	Protection for ULM cylinder <i>Kolbenstangenschutz ULM Zylinder</i>	265916
830E	PLN 11813	Ball valves for hydraulic piping grab open/close and grab rotating <i>Kugelhähne für die Hydraulikleitungen Greifer auf/zu und Greifer drehen</i>	260181
830E	PLN 10327	15 kW Magnet system with hydraulically driven generator (diesel machine) - without magnet system preparation <i>15 kW Magnetanlage mit hydraulisch angetriebenem Generator (Dieselmaschinen) - ohne Magnetanlagenvorbereitung</i>	259251
830E	PLN 11284	20 kW Magnet generator system with hydraulically driven generator <i>20 kW Magnetanlage mit hydraulisch angetriebenem Generator</i>	258554

830E Lights & Travel Alarm / Beleuchtung & Fahralarm

Model Modell	PLN PLN	Description Bezeichnung	No. Nr.
830E	PLN 13288	1 LED headlight mounted on the cab roof heading forwards <i>1 LED Scheinwerfer auf dem Kabinendach vorn</i>	259301
830E	PLN 10747	1 LED headlight mounted on the cab roof heading backwards <i>1 LED Scheinwerfer auf dem Kabinendach nach hinten</i>	259255
830E	PLN 13928	2 LED headlights mounted on the stick: 1 piece on left side, 1 piece on right side <i>2 LED Scheinwerfer am Stiel: je 1 Stück links und 1 Stück rechts</i>	259311
830E	PLN 13929	1 LED headlight mounted on the compact boom down side <i>1 LED Scheinwerfer am Kompaktausleger unten</i>	259313
830E	PLN 13930	1 LED headlight mounted on the compact boom upper side <i>1 LED Scheinwerfer am Kompaktausleger oben</i>	259316
830E	PLN 13931	2 LED headlights mounted on the sides of the upper-carriage: 1 piece on left side, 1 piece on right side <i>2 LED Scheinwerfer seitlich auf dem Oberwagen: je 1 Stück links und 1 Stück rechts</i>	259302

1.1 SERVICE & RETROFIT KITS / SERVICE & NACHRÜSTSÄTZE

Model Modell	PLN PLN	Description Bezeichnung	No. Nr.
830E	PLN 13932	1 LED headlight mounted on the counterweight heading backwards <i>1 LED Scheinwerfer auf dem Gegengewicht nach hinten gerichtet</i>	259324
830E	PLN 10751	Protection guard for integrated H4 headlight <i>Schutzgitter für H4 Einbauscheinwerfer</i>	259265
830E	PLN 10748	1 rotating beacon at the cab <i>1 Rundumleuchte an der Kabine</i>	259259
830E	PLN 10749	2 rotating beacons at rear of machine with intermittent horn for travel and swing <i>2 Rundumleuchten am Heck des Gerätes mit Intervallhupe für Fahren und Drehen</i>	259263
830E	PLN 16500	2 rotating beacons at rear of machine with intermittent horn <i>2 Rundumleuchten am Heck des Gerätes mit Intervallhupe</i>	258261
830E	PLN 5222	Intermittent horn for driving (travel alarm) <i>Intervallhupe für Fahren (Fahralarm)</i>	259241
830E	PLN 14683	Intermittent horn for driving (travel alarm), deactivation possible <i>Intervallhupe für Fahren (Fahralarm), abschaltbar</i>	259333

830E Camera Packages / Kamerapakete

Model Modell	PLN PLN	Description Bezeichnung	No. Nr.
830E	PLN 14661	Camera system – view under cabin <i>Kamerasystem für Kabinenunterbodenüberwachung</i>	260160
830E	PLN 10689	Camera system – add-on camera (1 piece) on the equipment <i>Kamerasystem – Erweiterung mit 1 Kamera an der Ausrüstung</i>	255202

830E Functions / Funktionen

Model Modell	PLN PLN	Description Bezeichnung	No. Nr.
830E	PLN 15319	SENtrack DS (Diesel, E-Series) for SENCON 1 <i>SENtrack DS (Diesel, E-Serie) für SENCON 1</i>	265783
830E	PLN 15319	SENtrack DS (Diesel, E-Series) for SENCON 2 <i>SENtrack DS (Diesel, E-Serie) für SENCON 2</i>	265782

1.1 SERVICE & RETROFIT KITS / SERVICE & NACHRÜSTSÄTZE

835D Service Packages / Inspections Sets Service-Pakete / Inspektionssätze

Service Intervals Serviceintervalle

Operating hours / Betriebsstunden	6000	3
	5500	1
	5000	2
	4500	1
	4000	3
	3500	1
	3000	2
	2500	1
	2000	3
	1500	1
	1000	2
	500	1
	250	A



Service Packages Service-Pakete

Model Modell	Emission Standard Abgasnorm	Configuration Ausstattung	No. Nr.	No. Nr.	No. Nr.	No. Nr.
835D	EU Stage III A / Tier 3	VF WA	164550	180857	180934	181066
		VF WAH	164550	180858	180935	181067
		HC WA	164551	180857	180934	181068
		HC WAH	164551	180858	180935	181069

Hydraulic Oil Filtration Hydraulikölfiltration

VF: standard HC: HydroClean
VF: Standard HC: HydroClean

Water Separator Wasserabscheider

WA: standard WAH: heatable
WA: Standard WAH: beheizbar

Inspection Sets Inspektionssätze

Model Modell	Emission Standard Abgasnorm	No. Nr.	No. Nr.	No. Nr.	No. Nr.
835D	EU Stage III A / Tier 3	162247	162248	162249	162250



1.1 SERVICE & RETROFIT KITS / SERVICE & NACHRÜSTSÄTZE

835E

Service Packages / Inspections Sets / Retrofit Kits
Service-Pakete / Inspektionssätze / Nachrüstätze

Service Intervals
Serviceintervalle

Operating hours / Betriebsstunden	6000	3
	5500	1
	5000	2
	4500	1
	4000	3
	3500	1
	3000	2
	2500	1
	2000	3
	1500	1
	1000	2
	500	1
	250	A



7,0%
Price Advantage
Preisvorteil

Service Packages
Service-Pakete

			A	1	2	3
Model Modell	Emission Standard Abgasnorm	Configuration Ausstattung	No. Nr.	No. Nr.	No. Nr.	No. Nr.
835E	EU Stage III A / Tier 3	VF	252382	252384	252385	252386
		HC	252383	252384	252385	252387
	EU Stage III B / Tier 4i	VF	180839	180866	180950	180996
		HC	180840	180866	180950	180995
	EU Stage IV / Tier 4f	VF	187495	187497	187498	187499
		HC	187496	187497	187498	187500
	EU Stage V / Tier 4f	VF	249532	249530	249529	249528
		HC	249531	249530	249529	249527

Hydraulic Oil Filtration
Hydraulikölfiltration

VF: standard HC: HydroClean
VF: Standard HC: HydroClean

Inspection Sets
Inspektionssätze

20%
Price Advantage
Preisvorteil

Model Modell	Emission Standard Abgasnorm	No. Nr.	No. Nr.	No. Nr.	No. Nr.
835E	EU Stage III A / Tier 3		252388		252389
	EU Stage III B / Tier 4i		180585		180586
	EU Stage IV / Tier 4f		187501		187502
	EU Stage V / Tier 4f		249526		249525

Water Separator
Wasserabscheider

WA: standard WAH: heatable
WA: Standard WAH: beheizbar

1.1 SERVICE & RETROFIT KITS / SERVICE & NACHRÜSTSÄTZE

835E Undercarriage / Unterwagen

Model Modell	PLN PLN	Description Bezeichnung	No. Nr.
835E	PLN 12384	Solid rubber tires 12.00-24 (8 units) for MP41 <i>Vollgummireifen 12.00-24 (8-fach) für MP41</i>	271520
835E	PLN 10134	Solid rubber tires 14.00-24 (8 units) for MP42 <i>Vollgummireifen 14.00-24 (8-fach) für MP42</i>	271611
835E	PLN 12514	Air tires 16.00-25, 4 units for MP34, MP38-HDS <i>Luftreifen 16.00-25, 4-fach für MP34, MP38-HDS</i>	271521
835E	PLN 11421	Single air tires 650/65 R 25 (4 units), Bridgestone VTS for MP38-T <i>Single Luftreifen 650/65 R 25 (4-fach), Bridgestone VTS für MP38-T</i>	271522
835E	PLN 13894	Hitch (up to 200 Kn pulling force, no vertical load) for wheeled machine <i>Rangierkupplung (bis max. 200 Kn Zugkraft, keine Stützlast) für Mobilgerät</i>	260159
835E	PLN 12389	Protection for drive train, MP41 <i>Schutz für den Fahrtrieb, MP41</i>	260176
835E	PLN 10790	Protection for drive train, MP42 <i>Schutz für den Fahrtrieb, MP42</i>	271532
835E	PLN 10436	Protection for drive train, MP38-T <i>Schutz für den Fahrtrieb, MP38-T</i>	271511
835E	PLN 16725	Protection for drive train, MP38-HDS <i>Schutz für den Fahrtrieb, MP38-HDS</i>	271515

835E Uppercarriage / Oberwagen

Model Modell	PLN PLN	Description Bezeichnung	No. Nr.
835E	PLN 16203	Additional counterweight 0.6 t <i>Zusatzballast 0,6 t</i>	271530
835E	PLN 16482	Counterweight fixture <i>Sicherung Gegengewicht</i>	255498
835E	PLN 10281	Hand rail at the upper structure for diesel machines, tiltable for transportation <i>Geländer am Oberwagen für Dieselmotoren, abklappbar für Transport</i>	259249
835E	PLN 14710	Hand rail at the upper structure for electric machines, tiltable for transportation <i>Geländer am Oberwagen für Elektromotoren, abklappbar für Transport</i>	259334
835E	PLN 12804	Low temperature package, diesel machine with electric preheating devices <i>Tieftemperatur-Paket, Dieselmotor mit elektrischen Vorheizgeräten</i>	271507
835E	PLN 10517	Electric preheating for hydraulic tank, 230 V, diesel machine (EU Stage III A / Tier 3) <i>Elektr. Hydrauliktankvorwärmung, 230 V für Dieselmotoren (EU Stufe III A / Tier 3)</i>	271509
835E	PLN 10517	Electric preheating for hydraulic tank, 230 V, diesel machine (EU Stage IV / Tier 4f) <i>Elektr. Hydrauliktankvorwärmung, 230 V für Dieselmotoren (EU Stufe IV / Tier 4f)</i>	271510
835E	PLN 10687	Diesel refuelling pump (50 l/min) <i>Diesel-Betankungspumpe (50 l/min)</i>	271527
835E	PLN 16057	Cyclone air pre-cleaner – diesel engine EU Stage III A, V / Tier 3, 4f <i>Zyklon-Vorabscheider – Dieselmotor EU Stufe III A, V / Tier 3, 4f</i>	259352
835E	PLN 10030	SENNEBOGEN Hydro Clean <i>SENNEBOGEN Hydro Clean</i>	271525
835E	PLN 11166	Jump start connection (positive pole) <i>Fremdstart (Pluspol)</i>	260169

1.1 SERVICE & RETROFIT KITS / SERVICE & NACHRÜSTSÄTZE

835E Boom / Ausleger

Model Modell	PLN PLN	Description Bezeichnung	No. Nr.
835E	PLN 11813	Ball valves for hydraulic piping grab open/close and grab rotating <i>Kugelhähne für die Hydraulikleitungen Greifer auf/zu und Greifer drehen</i>	260181
835E	PLN 13627	Boom damping system 835E <i>Auslegerdämpfung 835E</i>	238386
835E	PLN 10544 + 10545	Hoist limit switch for grab stick and loading boom <i>Hubbegrenzung für Greiferstiel und Kompaktausleger</i>	271622
835E	PLN 13920	Pressure indicator (boom cylinder) with Bargraph display (SENCON) and acoustical warning <i>Bargraph Druck-Anzeige (Hubzylinder) im SENCON mit akustischer Warnung</i>	260182
835E	PLN 14549	Pressure indicator (boom cylinder) with Bargraph display in the SENCON and acoustical warning, deactivation possible, bridgeable <i>Bargraph Druck-Anzeige (Hubzylinder) im SENCON mit akustischer Warnung, abschaltbar, überbrückbar</i>	260183
835E	PLN 15659	Protection for piston rod of lifting cylinders (835) <i>Kolbenstangenschutz an Hubzylindern (835)</i>	271531
835E	PLN 15661	Protection for piston rod of stick cylinders (835) <i>Kolbenstangenschutz an Stielzylindern (835)</i>	271623
835E	PLN 10324	15 kW Magnet system with hydraulically driven generator (diesel machine) <i>15 kW Magnetanlage mit hydraulisch angetriebenem Generator (nur für Dieselmotoren)</i>	259236
835E	PLN 10325	20 kW Magnet system with hydraulically driven generator (diesel machine) <i>20 kW Magnetanlage mit hydraulisch angetriebenem Generator (nur für Dieselmotoren)</i>	259250

835E Lights & Travel Alarm / Beleuchtung & Fahralarm

Model Modell	PLN PLN	Description Bezeichnung	No. Nr.
835E	PLN 13288	1 LED headlight mounted on the cab roof heading forwards <i>1 LED Scheinwerfer auf dem Kabinendach vorn</i>	259301
835E	PLN 10747	1 LED headlight mounted on the cab roof heading backwards <i>1 LED Scheinwerfer auf dem Kabinendach nach hinten</i>	259255
835E	PLN 13928	2 LED headlights mounted on the stick: 1 piece on left side, 1 piece on right side <i>2 LED Scheinwerfer am Stiel: je 1 Stück links und 1 Stück rechts</i>	259311
835E	PLN 13929	1 LED headlight mounted on the compact boom down side <i>1 LED Scheinwerfer am Kompaktausleger unten</i>	259313
835E	PLN 13930	1 LED headlight mounted on the compact boom upper side <i>1 LED Scheinwerfer am Kompaktausleger oben</i>	259316
835E	PLN 13931	2 LED headlights mounted on the sides of the upper-carriage: 1 piece on left side, 1 piece on right side <i>2 LED Scheinwerfer seitlich auf dem Oberwagen: je 1 Stück links und 1 Stück rechts</i>	259302
835E	PLN 13932	1 LED headlight mounted on the counterweight heading backwards <i>1 LED Scheinwerfer auf dem Gegengewicht nach hinten gerichtet</i>	259324
835E	PLN 10751	Protection guard for integrated H4 headlight <i>Schutzgitter für H4 Einbauscheinwerfer</i>	259265

1.1 SERVICE & RETROFIT KITS / SERVICE & NACHRÜSTSÄTZE

Model Modell	PLN PLN	Description Bezeichnung	No. Nr.
835E	PLN 10748	1 rotating beacon at the cab <i>1 Rundumleuchte an der Kabine</i>	259259
835E	PLN 16214	1 rotating beacon at rear of machine with intermittent horn <i>1 Rundumleuchte am Heck des Gerätes mit Intervallhupe</i>	259353
835E	PLN 10749	2 rotating beacons at rear of machine with intermittent horn for travel and swing <i>2 Rundumleuchten am Heck des Gerätes mit Intervallhupe für Fahren und Drehen</i>	259263
835E	PLN 16500	2 rotating beacons at rear of machine with intermittent horn <i>2 Rundumleuchten am Heck des Gerätes mit Intervallhupe</i>	258261
835E	PLN 5222	Intermittent horn for driving (travel alarm) <i>Intervallhupe für Fahren (Fahralarm)</i>	259241
835E	PLN 14683	Intermittent horn for driving (travel alarm), deactivation possible <i>Intervallhupe für Fahren (Fahralarm), abschaltbar</i>	259333

835E Camera Packages / Kamerapakete

Model Modell	PLN PLN	Description Bezeichnung	No. Nr.
835E	PLN 14661	Camera system - view under cabin <i>Kamerasystem für Kabinenunterbodenüberwachung</i>	260160
835E	PLN 10689	Camera system - add-on camera (1 piece) on the equipment <i>Kamerasystem - Erweiterung mit 1 Kamera an der Ausrüstung</i>	255202

835E Functions / Funktionen

Model Modell	PLN PLN	Description Bezeichnung	No. Nr.
835E	PLN 15319	SENtrack DS (Diesel, E-Series) for SENCON 1 <i>SENtrack DS (Diesel, E-Serie) für SENCON 1</i>	265783
835E	PLN 15319	SENtrack DS (Diesel, E-Series) for SENCON 2 <i>SENtrack DS (Diesel, E-Serie) für SENCON 2</i>	265782

1.1 SERVICE & RETROFIT KITS / SERVICE & NACHRÜSTSÄTZE

840D Service Packages / Inspections Sets

Service-Pakete / Inspektionssätze

Service Intervals
Serviceintervalle

Operating hours / Betriebsstunden	6000	3
	5500	1
	5000	2
	4500	1
	4000	3
	3500	1
	3000	2
	2500	1
	2000	3
	1500	1
	1000	2
	500	1
	250	A



7,0%
Price Advantage
Preisvorteil

Service Packages Service-Pakete		A	1	2	3	
Model Modell	Emission Standard Abgasnorm	Configuration Ausstattung	No. Nr.	No. Nr.	No. Nr.	No. Nr.
840D	EU Stage III A / Tier 3	VF WA	164550	180857	180934	181066
		VF WAH	164550	180858	180935	181067
		HC WA	164551	180857	180934	181068
		HC WAH	164551	180858	180935	181069

Hydraulic Oil Filtration
Hydraulikölfiltration

VF: standard HC: HydroClean
VF: Standard HC: HydroClean

Water Separator
Wasserabscheider

WA: standard WAH: heatable
WA: Standard WAH: beheizbar

20%
Price Advantage
Preisvorteil

Inspection Sets Inspektionssätze		VF WA	VF WAH	HC WA	HC WAH
Model Modell	Emission Standard Abgasnorm	No. Nr.	No. Nr.	No. Nr.	No. Nr.
840D	EU Stage III A / Tier 3	162247	162248	162249	162250

1.1 SERVICE & RETROFIT KITS / SERVICE & NACHRÜSTSÄTZE

840E Service Packages / Inspections Sets / Retrofit Kits Service-Pakete / Inspektionssätze / Nachrüstätze

Service Intervals Serviceintervalle

Operating hours / Betriebsstunden	6000	3
	5500	1
	5000	2
	4500	1
	4000	3
	3500	1
	3000	2
	2500	1
	2000	3
	1500	1
	1000	2
	500	1
	250	A



7,0%
Price Advantage
Preisvorteil

Service Packages Service-Pakete

Model Modell	Emission Standard Abgasnorm	Configuration Ausstattung	No. Nr.	No. Nr.	No. Nr.	No. Nr.
830E	EU Stage III B / Tier 4i	VF	180839	180866	180950	180996
		HC	180840	180866	180950	180995
	EU Stage IV / Tier 4f	VF	187495	187497	187498	187499
		HC	187496	187497	187498	187500

Hydraulic Oil Filtration Hydraulikölfiltration

VF: standard HC: HydroClean
VF: Standard HC: HydroClean

Water Separator Wasserabscheider

WA: standard WAH: heatable
WA: Standard WAH: beheizbar

Inspection Sets Inspektionssätze

Model Modell	Emission Standard Abgasnorm	No. Nr.	No. Nr.	No. Nr.	No. Nr.
830E	EU Stage III B / Tier 4i		180585		180586
	EU Stage IV / Tier 4f		187501		187502

20%
Price Advantage
Preisvorteil

1.1 SERVICE & RETROFIT KITS / SERVICE & NACHRÜSTSÄTZE

840E Undercarriage / Unterwagen

Model Modell	PLN PLN	Description Bezeichnung	No. Nr.
840E	PLN 10134	Solid rubber tires 14.00-24 (8 units) for MP42 <i>Vollgummireifen 14.00-24 (8-fach) für MP42</i>	271611
840E	PLN 13894	Hitch (up to 200 Kn pulling force, no vertical load) for wheeled machine <i>Rangierkupplung (bis max. 200 Kn Zugkraft, keine Stützlast) für Mobilgerät</i>	271614
840E	PLN 10790	Protection for drive train, MP42 <i>Schutz für den Fahrtrieb, MP42</i>	271532

840E Uppercarriage / Oberwagen

Model Modell	PLN PLN	Description Bezeichnung	No. Nr.
840E	PLN 15744	Hand rail at the upper structure for diesel machines, tiltable for transportation <i>Geländer am Oberwagen für Dieselmotoren, abklappbar für Transport</i>	259249
840E	PLN 15745	Hand rail at the upper structure for electric machines, tiltable for transportation <i>Geländer am Oberwagen für Elektromotoren, abklappbar für Transport</i>	259334
840E	PLN 12814	Low temperature package, diesel engine with electric preheating devices <i>Tiefemperatur-Paket, Dieselmotor mit elektrischen Vorheizgeräten</i>	271609
840E	PLN 10517	Electric preheating for hydraulic tank, 230 V, diesel machine (EU Stage III A / Tier 3) <i>Elektr. Hydrauliktankvorwärmung, 230 V für Dieselmotoren (EU Stufe III A / Tier 3)</i>	271509
840E	PLN 10517	Electric preheating for hydraulic tank, 230 V, diesel machine (EU Stage IV / Tier 4f) <i>Elektr. Hydrauliktankvorwärmung, 230 V für Dieselmotoren (EU Stufe IV / Tier 4f)</i>	271510
840E	PLN 10687	Diesel refuelling pump (50 l/min) <i>Diesel-Betankungspumpe (50 l/min)</i>	271527
840E	PLN 16057	Cyclone air pre-cleaner – diesel engine EU Stage III A, V / Tier 3, 4f <i>Zyklon-Vorabscheider – Dieselmotor EU Stufe III A, V / Tier 3, 4f</i>	259352
840E	PLN 10866	SENNEBOGEN Hydro Clean <i>SENNEBOGEN Hydro Clean</i>	271525
840E	PLN 11166	Jump start connection (positive pole) <i>Fremdstart (Pluspol)</i>	260169

840E Boom / Ausleger

Model Modell	PLN PLN	Description Bezeichnung	No. Nr.
840E	PLN 15849	Boom damping system 840E <i>Auslegerdämpfung 840E</i>	238387
840E	PLN 10916 + 10917	Hoist limit switch for grab stick and loading boom <i>Hubbegrenzung für Greiferstiel und Kompaktausleger</i>	271607
840E	PLN 13920	Pressure indicator (boom cylinder) with Bargraph display (SENCON) and acoustical warning <i>Bargraph Druck-Anzeige (Hubzylinder) im SENCON mit akustischer Warnung</i>	260182
840E	PLN 14549	Pressure indicator (boom cylinder) with Bargraph display in the SENCON and acoustical warning, deactivation possible, bridgeable <i>Bargraph Druck-Anzeige (Hubzylinder) im SENCON mit akustischer Warnung, abschaltbar, überbrückbar</i>	260183

1.1 SERVICE & RETROFIT KITS / SERVICE & NACHRÜSTSÄTZE

Model Modell	PLN PLN	Description Bezeichnung	No. Nr.
840E	PLN 15850	High-pressure filter for attachments <i>Hochdruckfilter für Anbaugeräte</i>	261476
840E	PLN 15851	Protection for piston rod of lifting cylinders <i>Kolbenstangenschutz an Hubzylindern</i>	271613
840E	PLN 15852	Protection for piston rod of stick cylinders <i>Kolbenstangenschutz an Stielzylindern</i>	271612
840E	PLN 10923	20 kW Magnet generator system with hydraulically driven generator <i>20 kW Magnetanlage mit hydraulisch angetriebenem Generator</i>	255946
840E	PLN 11813	Ball valves for hydraulic piping grab open/close and grab rotating <i>Kugelhähne für die Hydraulikleitungen Greifer auf/zu und Greifer drehen</i>	260181
840E	PLN 10900	Kinematics position Kin 1, Kin 2 <i>Kinematikposition Kin 1, Kin 2</i>	255323

840E Lights & Travel Alarm / Beleuchtung & Fahralarm

Model Modell	PLN PLN	Description Bezeichnung	No. Nr.
840E	PLN 13288	1 LED headlight mounted on the cab roof heading forwards <i>1 LED Scheinwerfer auf dem Kabinendach vorn</i>	259301
840E	PLN 10747	1 LED headlight mounted on the cab roof heading backwards <i>1 LED Scheinwerfer auf dem Kabinendach nach hinten</i>	259255
840E	PLN 13928	2 LED headlights mounted on the stick: 1 piece on left side, 1 piece on right side <i>2 LED Scheinwerfer am Stiel: je 1 Stück links und 1 Stück rechts</i>	259311
840E	PLN 13929	1 LED headlight mounted on the compact boom down side <i>1 LED Scheinwerfer am Kompaktausleger unten</i>	259313
840E	PLN 13930	1 LED headlight mounted on the compact boom upper side <i>1 LED Scheinwerfer am Kompaktausleger oben</i>	259316
840E	PLN 13931	2 LED headlights mounted on the sides of the upper-carriage: 1 piece on left side, 1 piece on right side <i>2 LED Scheinwerfer seitlich auf dem Oberwagen: je 1 Stück links und 1 Stück rechts</i>	259302
840E	PLN 13932	1 LED headlight mounted on the counterweight heading backwards <i>1 LED Scheinwerfer auf dem Gegengewicht nach hinten gerichtet</i>	259324

1.1 SERVICE & RETROFIT KITS / SERVICE & NACHRÜSTSÄTZE

Model Modell	PLN PLN	Description Bezeichnung	No. Nr.
840E	PLN 16290	1 LED flashing light at rear of machine <i>1 LED-Blitzleuchte am Heck des Gerätes</i>	259360
840E	PLN 10748	1 rotating beacon at the cab <i>1 Rundumleuchte an der Kabine</i>	259259
840E	PLN 10749	2 rotating beacons at rear of machine with intermittent horn for travel and swing <i>2 Rundumleuchten am Heck des Gerätes mit Intervallhupe für Fahren und Drehen</i>	259263
840E	PLN 16500	2 rotating beacons at rear of machine with intermittent horn <i>2 Rundumleuchten am Heck des Gerätes mit Intervallhupe</i>	258261
840E	PLN 5222	Intermittent horn for driving (travel alarm) <i>Intervallhupe für Fahren (Fahralarm)</i>	259241
840E	PLN 14683	Intermittent horn for driving (travel alarm), deactivation possible <i>Intervallhupe für Fahren (Fahralarm), abschaltbar</i>	259333

840E Camera Packages / Kamerapakete

Model Modell	PLN PLN	Description Bezeichnung	No. Nr.
840E	PLN 14661	Camera system - view under cabin <i>Kamerasystem für Kabinenunterbodenüberwachung</i>	260160
840E	PLN 10689	Camera system - add-on camera (1 piece) on the equipment <i>Kamerasystem - Erweiterung mit 1 Kamera an der Ausrüstung</i>	255202

840E Functions / Funktionen

Model Modell	PLN PLN	Description Bezeichnung	No. Nr.
840E	PLN 15319	SENtrack DS (Diesel, E-Series) for SENCON 1 <i>SENtrack DS (Diesel, E-Serie) für SENCON 1</i>	265783
840E	PLN 15319	SENtrack DS (Diesel, E-Series) for SENCON 2 <i>SENtrack DS (Diesel, E-Serie) für SENCON 2</i>	265782

1.1 SERVICE & RETROFIT KITS / SERVICE & NACHRÜSTSÄTZE

850D *Service Packages / Inspections Sets / Retrofit Kits* *Service-Pakete / Inspektionssätze / Nachrüstsätze*

Service Intervals *Serviceintervalle*

Operating hours / Betriebsstunden	6000	3
	5500	1
	5000	2
	4500	1
	4000	3
	3500	1
	3000	2
	2500	1
	2000	3
	1500	1
	1000	2
	500	1
	250	A



7,0%
Price Advantage
Preisvorteil

Service Packages *Service-Pakete*

Model <i>Modell</i>	Emission Standard <i>Abgasnorm</i>	Configuration <i>Ausstattung</i>	No. <i>Nr.</i>	No. <i>Nr.</i>	No. <i>Nr.</i>	No. <i>Nr.</i>
850D	EU Stage III A / Tier 3	VF WA	187024	180859	180936	181070
		VF WAH	164552	180860	180937	181071
		HC WA	187025	180859	180936	181072
		HC WAH	164553	180860	180937	181073

Hydraulic Oil Filtration *Hydraulikölfiltration*

VF: standard HC: HydroClean
VF: *Standard* HC: *HydroClean*

Water Separator *Wasserabscheider*

WA: standard WAH: heatable
WA: *Standard* WAH: *beheizbar*

Inspection Sets *Inspektionssätze*

Model <i>Modell</i>	Emission Standard <i>Abgasnorm</i>	No. <i>Nr.</i>	No. <i>Nr.</i>	No. <i>Nr.</i>	No. <i>Nr.</i>
850D	EU Stage III A / Tier 3	162251	162252	162253	162254

20%
Price Advantage
Preisvorteil

1.1 SERVICE & RETROFIT KITS / SERVICE & NACHRÜSTSÄTZE

850D Undercarriage / Unterwagen

Model Modell	PLN PLN	Description Bezeichnung	No. Nr.
850D	---	---	---

850D Uppercarriage / Oberwagen

Model Modell	PLN PLN	Description Bezeichnung	No. Nr.
850D	---	---	---

850D Boom / Ausleger

Model Modell	PLN PLN	Description Bezeichnung	No. Nr.
850D	PLN 2864	Ball valves for hydraulic piping grab open/close and grab rotating <i>Kugelhähne für die Hydraulikleitungen Greifer auf/zu und Greifer drehen</i>	260181

850D Lights & Travel Alarm / Beleuchtung & Fahralarm

Model Modell	PLN PLN	Description Bezeichnung	No. Nr.
850D	PLN 5222	Intermittent horn for driving (travel alarm) <i>Intervallhupe für Fahren (Fahralarm)</i>	259241

850D Camera Packages / Kamerapakete

Model Modell	PLN PLN	Description Bezeichnung	No. Nr.
850D	PLN 14661	Camera system – view under cabin <i>Kamerasystem für Kabinenunterbodenüberwachung</i>	260160
850D	PLN 7475	Camera system – add-on camera (1 piece) <i>Kamerasystem – Erweiterung mit 1 Kamera</i>	255202

850D Functions / Funktionen

Model Modell	PLN PLN	Description Bezeichnung	No. Nr.
850D	---	---	---

1.1 SERVICE & RETROFIT KITS / SERVICE & NACHRÜSTSÄTZE

850E Service Packages / Inspections Sets / Retrofit Kits Service-Pakete / Inspektionssätze / Nachrüstätze

Service Intervals Serviceintervalle

Operating hours / Betriebsstunden	6000	3
	5500	1
	5000	2
	4500	1
	4000	3
	3500	1
	3000	2
	2500	1
	2000	3
	1500	1
	1000	2
	500	1
	250	A



Service Packages Service-Pakete

Model Modell	Emission Standard Abgasnorm	Configuration Ausstattung	A	1	2	3
850E	EU Stage V / Tier 4f	VF HC		on request / auf Anfrage	on request / auf Anfrage	on request / auf Anfrage

Hydraulic Oil Filtration Hydraulikölfiltration

VF: standard HC: HydroClean
VF: Standard HC: HydroClean

Water Separator Wasserabscheider

WA: standard WAH: heatable
WA: Standard WAH: beheizbar



Inspection Sets Inspektionssätze

Model Modell	Emission Standard Abgasnorm	VF WA	VF WAH	HC WA	HC WAH
850E	EU Stage V / Tier 4f	on request / auf Anfrage	on request / auf Anfrage	on request / auf Anfrage	on request / auf Anfrage

1.1 SERVICE & RETROFIT KITS / SERVICE & NACHRÜSTSÄTZE

850E Undercarriage / Unterwagen

Model Modell	PLN PLN	Description Bezeichnung	No. Nr.
850E	PLN 16254	Solid rubber tires, 16.00-25 (8 units) – diameter 1,500 mm for MP50E <i>Vollgummireifen 16.00-25 (8-fach) – Durchmesser 1.500 mm für MP50E</i>	271584
850E	PLN 13116	Protection for drive train, MP50E <i>Schutz für den Fahrtrieb, MP50E</i>	271532

850E Uppercarriage / Oberwagen

Model Modell	PLN PLN	Description Bezeichnung	No. Nr.
850E	PLN 7999	Additional counterweight 3.2 t for mobile machines <i>Zusatzballast 3,2 t für Mobilgeräte</i>	271606
850E	PLN 16236	Hand rail at the upper structure for diesel machines, tiltable for transportation <i>Geländer am Oberwagen für Dieselmotoren, abklappbar für Transport</i>	271605
850E	PLN 16237	Hand rail at the upper structure for electric machines, tiltable for transportation <i>Geländer am Oberwagen für Elektromotoren, abklappbar für Transport</i>	271604
850E	PLN 15017	Low temperature package, diesel machine with electric preheating devices <i>Tieftemperatur-Paket, Dieselmotor mit elektrischen Vorheizgeräten</i>	271598
850E	PLN 15561	Electric preheating for hydraulic tank, 230 V, diesel machine <i>Elektr. Hydrauliktankvorwärmung, 230 V für Dieselmotoren</i>	271580
850E	PLN 10687	Diesel refuelling pump (50 l/min) <i>Diesel-Betankungspumpe (50 l/min)</i>	271603
850E	PLN 16058	Cyclone air pre-cleaner – diesel engine EU Stage III A, V / Tier 3, 4f <i>Zyklon-Vorabscheider – Dieselmotor EU Stufe III A, V / Tier 3, 4f</i>	271583
850E	PLN 15019	SENNEBOGEN Hydro Clean <i>SENNEBOGEN Hydro Clean</i>	271602
850E	PLN 11166	Jump start connection (positive pole) <i>Fremdstart (Pluspol)</i>	260169

850E Boom / Ausleger

Model Modell	PLN PLN	Description Bezeichnung	No. Nr.
850E	PLN 2027 + 2028	Hoist limit switch for grab stick and loading boom <i>Hubbegrenzung für Greiferstiel und Kompaktausleger</i>	271595
850E	PLN 13920	Pressure indicator (boom cylinder) with Bargraph display (SENCON) and acoustical warning <i>Bargraph Druck-Anzeige (Hubzylinder) im SENCON mit akustischer Warnung</i>	271600
850E	PLN 14549	Pressure indicator (boom cylinder) with Bargraph display in the SENCON and acoustical warning, deactivation possible, bridgeable <i>Bargraph Druck-Anzeige (Hubzylinder) im SENCON mit akustischer Warnung, abschaltbar, überbrückbar</i>	260183
850E	PLN 16773	Protection for piston rod of stick cylinders <i>Kolbenstangenschutz an Stielzylindern</i>	271597

1.1 SERVICE & RETROFIT KITS / SERVICE & NACHRÜSTSÄTZE

850E Boom / Ausleger

Model Modell	PLN PLN	Description Bezeichnung	No. Nr.
850E	PLN 16249	20 kW Magnet system with hydraulically driven generator (diesel machine) <i>20 kW Magnetanlage mit hydraulisch angetriebenem Generator (nur für Dieselmotoren)</i>	259356
850E	PLN 4679	25 kW Magnet system with hydraulically driven generator (diesel machine) <i>25 kW Magnetanlage mit hydraulisch angetriebenem Generator (nur für Dieselmotoren)</i>	259239
850E	PLN 11813	Ball valves for hydraulic piping grab open/close and grab rotating <i>Kugelhähne für die Hydraulikleitungen Greifer auf/zu und Greifer drehen</i>	260181

850E Lights & Travel Alarm / Beleuchtung & Fahralarm

Model Modell	PLN PLN	Description Bezeichnung	No. Nr.
850E	PLN 13288	1 LED headlight mounted on the cab roof heading forwards <i>1 LED Scheinwerfer auf dem Kabinendach vorn</i>	259301
850E	PLN 10747	1 LED headlight mounted on the cab roof heading backwards <i>1 LED Scheinwerfer auf dem Kabinendach nach hinten</i>	259255
850E	PLN 13928	2 LED headlights mounted on the stick: 1 piece on left side, 1 piece on right side <i>2 LED Scheinwerfer am Stiel: je 1 Stück links und 1 Stück rechts</i>	259311
850E	PLN 13929	1 LED headlight mounted on the compact boom down side <i>1 LED Scheinwerfer am Kompaktausleger unten</i>	259313
850E	PLN 13930	1 LED headlight mounted on the compact boom upper side <i>1 LED Scheinwerfer am Kompaktausleger oben</i>	259316
850E	PLN 13931	2 LED headlights mounted on the sides of the upper-carriage: 1 piece on left side, 1 piece on right side <i>2 LED Scheinwerfer seitlich auf dem Oberwagen: je 1 Stück links und 1 Stück rechts</i>	259302
850E	PLN 13932	1 LED headlight mounted on the counterweight heading backwards <i>1 LED Scheinwerfer auf dem Gegengewicht nach hinten gerichtet</i>	259325
850E	PLN 10751	Protection guard for integrated H4 headlight <i>Schutzgitter für H4 Einbauscheinwerfer</i>	259266
850E	PLN 10748	1 rotating beacon at the cab <i>1 Rundumleuchte an der Kabine</i>	259259
850E	PLN 10749	2 rotating beacons at rear of machine with intermittent horn for travel and swing <i>2 Rundumleuchten am Heck des Gerätes mit Intervallhupe für Fahren und Drehen</i>	259263
850E	PLN 16500	2 rotating beacons at rear of machine with intermittent horn <i>2 Rundumleuchten am Heck des Gerätes mit Intervallhupe</i>	258261
850E	PLN 5222	Intermittent horn for driving (travel alarm) <i>Intervallhupe für Fahren (Fahralarm)</i>	259241
850E	PLN 14683	Intermittent horn for driving (travel alarm), deactivation possible <i>Intervallhupe für Fahren (Fahralarm), abschaltbar</i>	259333

1.1 SERVICE & RETROFIT KITS / SERVICE & NACHRÜSTSÄTZE

850E Camera Packages / Kamerapakete

Model Modell	PLN PLN	Description Bezeichnung	No. Nr.
850E	PLN 14661	Camera system – view under cabin <i>Kamerasystem für Kabinenunterbodenüberwachung</i>	260160
850E	PLN 10689	Camera system – add-on camera (1 piece) on the equipment <i>Kamerasystem – Erweiterung mit 1 Kamera an der Ausrüstung</i>	255202

850E Functions / Funktionen

Model Modell	PLN PLN	Description Bezeichnung	No. Nr.
850E	PLN 15319	SENtrack DS (Diesel, E-Series) for SENCON 1 <i>SENtrack DS (Diesel, E-Serie) für SENCON 1</i>	265783
850E	PLN 15319	SENtrack DS (Diesel, E-Series) for SENCON 2 <i>SENtrack DS (Diesel, E-Serie) für SENCON 2</i>	265782

1.1 SERVICE & RETROFIT KITS / SERVICE & NACHRÜSTSÄTZE

855E Service Packages / Inspections Sets / Retrofit Kits Service-Pakete / Inspektionssätze / Nachrüstätze

Service Intervals Serviceintervalle

Operating hours / Betriebsstunden	6000	3
	5500	1
	5000	2
	4500	1
	4000	3
	3500	1
	3000	2
	2500	1
	2000	3
	1500	1
	1000	2
	500	1
	250	A



Service Packages Service-Pakete

Model Modell	Emission Standard Abgasnorm	Configuration Ausstattung	A	1	2	3
855E	EU Stage V / Tier 4f	VF HC		on request / auf Anfrage	on request / auf Anfrage	on request / auf Anfrage

Hydraulic Oil Filtration Hydraulikölfiltration

VF: standard HC: HydroClean
VF: Standard HC: HydroClean

Water Separator Wasserabscheider

WA: standard WAH: heatable
WA: Standard WAH: beheizbar



Inspection Sets Inspektionssätze

Model Modell	Emission Standard Abgasnorm	VF WA	VF WAH	HC WA	HC WAH
855E	EU Stage V / Tier 4f	on request / auf Anfrage	on request / auf Anfrage	on request / auf Anfrage	on request / auf Anfrage

1.1 SERVICE & RETROFIT KITS / SERVICE & NACHRÜSTSÄTZE

855E Undercarriage / Unterwagen

Model Modell	PLN PLN	Description Bezeichnung	No. Nr.
855E	PLN 16255	Solid rubber tires, 16.00-25 (8 units) – diameter 1,500 mm for MP71E <i>Vollgummireifen 16.00-25 (8-fach) – Durchmesser 1.500 mm für MP71E</i>	271584
855E	PLN 13117	Protection for drive train, MP71E <i>Schutz für den Fahrtrieb, MP71E</i>	271594
855E	PLN 12863	Protection for drive train, MP80E <i>Schutz für den Fahrtrieb, MP80E</i>	271593

855E Uppercarriage / Oberwagen

Model Modell	PLN PLN	Description Bezeichnung	No. Nr.
855E	PLN 14532	Additional counterweight 2.2 t for mobile machines <i>Zusatzballast 2,2 t für Mobilgeräte</i>	271592
855E	PLN 14945	Additional counterweight 2.2 t + 1.5 t for machine with mobile undercarriage <i>Zusatzballast 2,2 t + 1,5 t für Maschine mit Mobilunterwagen</i>	271591
855E	PLN 16092	Additional counterweight 1.5 t, only with crawler undercarriage and stationary <i>Zusatzballast 1,5 t, nur für Raupe und Aufbau</i>	271579
855E	PLN 15558	Low temperature package, diesel engine with electric preheating devices <i>Tieftemperatur-Paket, Dieselmotor mit elektrischen Vorheizgeräten</i>	271577
855E	PLN 15561	Electric preheating for hydraulic tank, 230 V, diesel machine <i>Elektr. Hydrauliktankvorwärmung, 230 V für Dieselmotoren</i>	271580
855E	PLN 10687	Diesel refuelling pump (50 l/min) <i>Diesel-Betankungspumpe (50 l/min)</i>	271589
855E	PLN 16610	Cyclone air pre-cleaner – diesel engine EU Stage III A, V / Tier 3, 4f <i>Zyklon-Vorabscheider – Dieselmotor EU Stufe III A, V / Tier 3, 4f</i>	271583
855E	PLN 13621	SENNEBOGEN Hydro Clean <i>SENNEBOGEN Hydro Clean</i>	271587
855E	PLN 11166	Jump start connection (positive pole) <i>Fremdstart (Pluspol)</i>	271585

855E Boom / Ausleger

Model Modell	PLN PLN	Description Bezeichnung	No. Nr.
855E	PLN 15667	Boom damping system <i>Auslegerdämpfung</i>	241716
855E	PLN 2027 + 2028	Hoist limit switch for grab stick and loading boom <i>Hubbegrenzung für Greiferstiel und Kompaktausleger</i>	271581
855E	PLN 13920	Pressure indicator (boom cylinder) with Bargraph display (SENCON) and acoustical warning <i>Bargraph Druck-Anzeige (Hubzylinder) im SENCON mit akustischer Warnung</i>	263262
855E	PLN 14549	Pressure indicator (boom cylinder) with Bargraph display in the SENCON and acoustical warning, deactivation possible, bridgeable <i>Bargraph Druck-Anzeige (Hubzylinder) im SENCON mit akustischer Warnung, abschaltbar, überbrückbar</i>	260183
855E	PLN 12899	25 kW Magnet generator system with hydraulically driven generator, Diesel <i>25 kW Magnetanlage mit hydraulisch angetriebenem Generator, Diesel</i>	259339
855E	PLN 2864	Ball valves for hydraulic piping grab open/close and grab rotating <i>Kugelhähne für die Hydraulikleitungen Greifer auf/zu und Greifer drehen</i>	260181

1.1 SERVICE & RETROFIT KITS / SERVICE & NACHRÜSTSÄTZE

855E Lights & Travel Alarm / Beleuchtung & Fahralarm

Model Modell	PLN PLN	Description Bezeichnung	No. Nr.
855E	PLN 13288	1 LED headlight mounted on the cab roof heading forwards <i>1 LED Scheinwerfer auf dem Kabinendach vorn</i>	259301
855E	PLN 10747	1 LED headlight mounted on the cab roof heading backwards <i>1 LED Scheinwerfer auf dem Kabinendach nach hinten</i>	259255
855E	PLN 13929	1 LED headlight mounted on the compact boom down side <i>1 LED Scheinwerfer am Kompaktausleger unten</i>	259313
855E	PLN 13930	1 LED headlight mounted on the compact boom upper side <i>1 LED Scheinwerfer am Kompaktausleger oben</i>	259316
855E	PLN 13928	2 LED headlights mounted on the stick: 1 piece on left side, 1 piece on right side <i>2 LED Scheinwerfer am Stiel: je 1 Stück links und 1 Stück rechts</i>	259312
855E	PLN 13932	1 LED headlight mounted on the counterweight heading backwards <i>1 LED Scheinwerfer auf dem Gegengewicht nach hinten gerichtet</i>	259325
855E	PLN 13931	2 LED headlights mounted on the sides of the upper-carriage: 1 piece on left side, 1 piece on right side <i>2 LED Scheinwerfer seitlich auf dem Oberwagen: je 1 Stück links und 1 Stück rechts</i>	259302
855E	PLN 10751	Protection guard for integrated H4 headlight <i>Schutzgitter für H4 Einbauscheinwerfer</i>	259267
855E	PLN 10748	1 rotating beacon at the cab <i>1 Rundumleuchte an der Kabine</i>	259259
855E	PLN 10749	2 rotating beacons at rear of machine with intermittent horn for travel and swing <i>2 Rundumleuchten am Heck des Gerätes mit Intervallhupe für Fahren und Drehen</i>	259264
855E	PLN 16500	2 rotating beacons at rear of machine with intermittent horn <i>2 Rundumleuchten am Heck des Gerätes mit Intervallhupe</i>	258261
855E	PLN 5222	Intermittent horn for driving (travel alarm) <i>Intervallhupe für Fahren (Fahralarm)</i>	259241
855E	PLN 14683	Intermittent horn for driving (travel alarm), deactivation possible <i>Intervallhupe für Fahren (Fahralarm), abschaltbar</i>	259333

855E Camera Packages / Kamerapakete

Model Modell	PLN PLN	Description Bezeichnung	No. Nr.
855E	PLN 14661	Camera system – view under cabin <i>Kamerasystem für Kabinenunterbodenüberwachung</i>	260160
855E	PLN 10689	Camera system – add-on camera (1 piece) on the equipment <i>Kamerasystem – Erweiterung mit 1 Kamera an der Ausrüstung</i>	263256

855E Functions / Funktionen

Model Modell	PLN PLN	Description Bezeichnung	No. Nr.
855E	PLN 15319	SENtrack DS (Diesel, E-Series) for SENCON 1 <i>SENtrack DS (Diesel, E-Serie) für SENCON 1</i>	265783
855E	PLN 15319	SENtrack DS (Diesel, E-Series) for SENCON 2 <i>SENtrack DS (Diesel, E-Serie) für SENCON 2</i>	265782

1.1 SERVICE & RETROFIT KITS / SERVICE & NACHRÜSTSÄTZE

860D

Service Packages / Inspections Sets / Retrofit Kits
 Service-Pakete / Inspektionssätze / Nachrüstätze

Service Intervals
 Serviceintervalle

Operating hours / Betriebsstunden	6000	3
	5500	1
	5000	2
	4500	1
	4000	3
	3500	1
	3000	2
	2500	1
	2000	3
	1500	1
	1000	2
	500	1
	250	A



Service Packages
 Service-Pakete

Model Modell	Emission Standard Abgasnorm	Configuration Ausstattung	No. Nr.	No. Nr.	No. Nr.	No. Nr.
860D	EU Stage III A / Tier 3	VF WA	187024	180859	180936	181070
		VF WAH	164552	180860	180937	181071
		HC WA	187025	180859	180936	181072
		HC WAH	164553	180860	180937	181073

Hydraulic Oil Filtration
 Hydraulikölfiltration

VF: standard HC: HydroClean
 VF: Standard HC: HydroClean

Water Separator
 Wasserabscheider

WA: standard WAH: heatable
 WA: Standard WAH: beheizbar



Inspection Sets
 Inspektionssätze

Model Modell	Emission Standard Abgasnorm	No. Nr.	No. Nr.	No. Nr.	No. Nr.
860D	EU Stage III A / Tier 3	162251	162252	162253	162254

1.1 SERVICE & RETROFIT KITS / SERVICE & NACHRÜSTSÄTZE

860D Undercarriage / Unterwagen

Model Modell	PLN PLN	Description Bezeichnung	No. Nr.
860D	---	---	---

860D Uppercarriage / Oberwagen

Model Modell	PLN PLN	Description Bezeichnung	No. Nr.
860D	---	---	---

860D Boom / Ausleger

Model Modell	PLN PLN	Description Bezeichnung	No. Nr.
860D	PLN 2864	Ball valves for hydraulic piping grab open/close and grab rotating <i>Kugelhähne für die Hydraulikleitungen Greifer auf/zu und Greifer drehen</i>	260181

860D Lights & Travel Alarm / Beleuchtung & Fahralarm

Model Modell	PLN PLN	Description Bezeichnung	No. Nr.
860D	PLN 5222	Intermittent horn for driving (travel alarm) <i>Intervallhupe für Fahren (Fahralarm)</i>	259241

860D Camera Packages / Kamerapakete

Model Modell	PLN PLN	Description Bezeichnung	No. Nr.
860D	PLN 14661	Camera system – view under cabin <i>Kamerasystem für Kabinenunterbodenüberwachung</i>	260160

860D Functions / Funktionen

Model Modell	PLN PLN	Description Bezeichnung	No. Nr.
860D	---	---	---

1.1 SERVICE & RETROFIT KITS / SERVICE & NACHRÜSTSÄTZE

860E

Service Packages / Inspections Sets / Retrofit Kits
 Service-Pakete / Inspektionssätze / Nachrüstätze

Service Intervals
 Serviceintervalle

Operating hours / Betriebsstunden	6000	3
	5500	1
	5000	2
	4500	1
	4000	3
	3500	1
	3000	2
	2500	1
	2000	3
	1500	1
	1000	2
	500	1
	250	A



Service Packages
 Service-Pakete

			A	1	2	3
Model Modell	Emission Standard Abgasnorm	Configuration Ausstattung	No. Nr.	No. Nr.	No. Nr.	No. Nr.
860E	EU Stage V / Tier 4f	VF HC	on request / auf Anfrage			

Hydraulic Oil Filtration
 Hydraulikölfiltration

VF: standard HC: HydroClean
 VF: Standard HC: HydroClean

Water Separator
 Wasserabscheider

WA: standard WAH: heatable
 WA: Standard WAH: beheizbar



Inspection Sets
 Inspektionssätze

		VF WA	VF WAH	HC WA	HC WAH
Model Modell	Emission Standard Abgasnorm	No. Nr.	No. Nr.	No. Nr.	No. Nr.
860E	EU Stage V / Tier 4f	on request / auf Anfrage			

1.1 SERVICE & RETROFIT KITS / SERVICE & NACHRÜSTSÄTZE

860E Undercarriage / Unterwagen

Model Modell	PLN PLN	Description Bezeichnung	No. Nr.
860E	---	---	---

860E Uppercarriage / Oberwagen

Model Modell	PLN PLN	Description Bezeichnung	No. Nr.
860E	PLN 11190	Diesel refuelling pump with extended hauling output 100 l/min and height <i>Diesel-Betankungspumpe mit erhöhter Förderleistung 100 l/min und -höhe</i>	263253
860E	PLN 11166	Jump start connection (positive pole) <i>Fremdstart (Pluspol)</i>	260169

860E Boom / Ausleger

Model Modell	PLN PLN	Description Bezeichnung	No. Nr.
860E	PLN 13920	Pressure indicator (boom cylinder) with Bargraph display (SENCON) and acoustical warning <i>Bargraph Druck-Anzeige (Hubzylinder) im SENCON mit akustischer Warnung</i>	263262
860E	PLN 13061	20 kW Magnet generator system with hydraulically driven generator, Diesel <i>20 kW Magnetanlage mit hydraulisch angetriebenem Generator, Diesel</i>	259287
860E	PLN 12899	25 kW Magnet generator system with hydraulically driven generator, Diesel <i>25 kW Magnetanlage mit hydraulisch angetriebenem Generator, Diesel</i>	259283
860E	PLN 2864	Ball valves for hydraulic piping grab open/close and grab rotating <i>Kugelhähne für die Hydraulikleitungen Greifer auf/zu und Greifer drehen</i>	260181

860E Lights & Travel Alarm / Beleuchtung & Fahralarm

Model Modell	PLN PLN	Description Bezeichnung	No. Nr.
860E	PLN 13288	1 LED headlight mounted on the cab roof heading forwards <i>1 LED Scheinwerfer auf dem Kabinendach vorn</i>	259301
860E	PLN 10747	1 LED headlight mounted on the cab roof heading backwards <i>1 LED Scheinwerfer auf dem Kabinendach nach hinten</i>	259255
860E	PLN 13929	1 LED headlight mounted on the compact boom down side <i>1 LED Scheinwerfer am Kompaktausleger unten</i>	259313
860E	PLN 13930	1 LED headlight mounted on the compact boom upper side <i>1 LED Scheinwerfer am Kompaktausleger oben</i>	259316
860E	PLN 13928	2 LED headlights mounted on the stick: 1 piece on left side, 1 piece on right side <i>2 LED Scheinwerfer am Stiel: je 1 Stück links und 1 Stück rechts</i>	259312
860E	PLN 13931	2 LED headlights mounted on the sides of the upper-carriage: 1 piece on left side, 1 piece on right side <i>2 LED Scheinwerfer seitlich auf dem Oberwagen: je 1 Stück links und 1 Stück rechts</i>	259302
860E	PLN 13932	1 LED headlight mounted on the counterweight heading backwards <i>1 LED Scheinwerfer auf dem Gegengewicht nach hinten gerichtet</i>	259325

1.1 SERVICE & RETROFIT KITS / SERVICE & NACHRÜSTSÄTZE

Model Modell	PLN PLN	Description Bezeichnung	No. Nr.
860E	PLN 10751	Protection guard for integrated H4 headlight <i>Schutzgitter für H4 Einbauscheinwerfer</i>	259268
860E	PLN 10748	1 rotating beacon at the cab <i>1 Rundumleuchte an der Kabine</i>	259259
860E	PLN 10749	2 rotating beacons at rear of machine with intermittent horn for travel and swing <i>2 Rundumleuchten am Heck des Gerätes mit Intervallhupe für Fahren und Drehen</i>	259264
860E	PLN 16500	2 rotating beacons at rear of machine with intermittent horn <i>2 Rundumleuchten am Heck des Gerätes mit Intervallhupe</i>	258261
860E	PLN 5222	Intermittent horn for driving (travel alarm) <i>Intervallhupe für Fahren (Fahralarm)</i>	259241
860E	PLN 14683	Intermittent horn for driving (travel alarm), deactivation possible <i>Intervallhupe für Fahren (Fahralarm), abschaltbar</i>	259333

860E Camera Packages / Kamerapakete

Model Modell	PLN PLN	Description Bezeichnung	No. Nr.
860E	PLN 14661	Camera system – view under cabin <i>Kamerasystem für Kabinenunterbodenüberwachung</i>	260160
860E	PLN 10689	Camera system – add-on camera (1 piece) on the equipment <i>Kamerasystem – Erweiterung mit 1 Kamera an der Ausrüstung</i>	263256

860E Functions / Funktionen

Model Modell	PLN PLN	Description Bezeichnung	No. Nr.
860E	PLN 15319	SENtrack DS (Diesel, E-Series) for SENCON 1 <i>SENtrack DS (Diesel, E-Serie) für SENCON 1</i>	265783
860E	PLN 15319	SENtrack DS (Diesel, E-Series) for SENCON 2 <i>SENtrack DS (Diesel, E-Serie) für SENCON 2</i>	265782

1.1 SERVICE & RETROFIT KITS / SERVICE & NACHRÜSTSÄTZE

870E Service Packages / Inspections Sets / Retrofit Kits Service-Pakete / Inspektionssätze / Nachrüstätze

Service Intervals Serviceintervalle

Operating hours / Betriebsstunden	6000	3
	5500	1
	5000	2
	4500	1
	4000	3
	3500	1
	3000	2
	2500	1
	2000	3
	1500	1
	1000	2
	500	1
	250	A



7,0%
Price Advantage
Preisvorteil

Service Packages Service-Pakete

Model Modell	Emission Standard Abgasnorm	Configuration Ausstattung	No. Nr.	No. Nr.	No. Nr.	No. Nr.
870E	EU Stage V / Tier 4f	VF HC	A	1	2	3
				on request / auf Anfrage		

Hydraulic Oil Filtration Hydraulikölfiltration

VF: standard HC: HydroClean
VF: Standard HC: HydroClean

Water Separator Wasserabscheider

WA: standard WAH: heatable
WA: Standard WAH: beheizbar

Inspection Sets Inspektionssätze

Model Modell	Emission Standard Abgasnorm	No. Nr.	No. Nr.	No. Nr.	No. Nr.
870E	EU Stage V / Tier 4f	VF WA	VF WAH	HC WA	HC WAH
		on request / auf Anfrage			

20%
Price Advantage
Preisvorteil

1.1 SERVICE & RETROFIT KITS / SERVICE & NACHRÜSTSÄTZE

870E Undercarriage / Unterwagen

Model Modell	PLN PLN	Description Bezeichnung	No. Nr.
870E	---	---	---

870E Uppercarriage / Oberwagen

Model Modell	PLN PLN	Description Bezeichnung	No. Nr.
870E	---	---	---

870E Boom / Ausleger

Model Modell	PLN PLN	Description Bezeichnung	No. Nr.
870E	PLN 2864	Ball valves for hydraulic piping grab open/close and grab rotating <i>Kugelhähne für die Hydraulikleitungen Greifer auf/zu und Greifer drehen</i>	260181

870E Lights & Travel Alarm / Beleuchtung & Fahralarm

Model Modell	PLN PLN	Description Bezeichnung	No. Nr.
870E	---	---	---

870E Camera Packages / Kamerapakete

Model Modell	PLN PLN	Description Bezeichnung	No. Nr.
870E	---	---	---

870E Functions / Funktionen

Model Modell	PLN PLN	Description Bezeichnung	No. Nr.
870E	PLN 15319	SENtrack DS (Diesel, E-Series) for SENCON 1 <i>SENtrack DS (Diesel, E-Serie) für SENCON 1</i>	265783
870E	PLN 15319	SENtrack DS (Diesel, E-Series) for SENCON 2 <i>SENtrack DS (Diesel, E-Serie) für SENCON 2</i>	265782

1.1 SERVICE & RETROFIT KITS / SERVICE & NACHRÜSTSÄTZE

875E Service Packages / Inspections Sets / Retrofit Kits Service-Pakete / Inspektionssätze / Nachrüstätze

Service Intervals Serviceintervalle

Operating hours / Betriebsstunden	6000	3
	5500	1
	5000	2
	4500	1
	4000	3
	3500	1
	3000	2
	2500	1
	2000	3
	1500	1
	1000	2
	500	1
	250	A



Service Packages Service-Pakete

Model Modell	Emission Standard Abgasnorm	Configuration Ausstattung	A	1	2	3
875E	EU Stage III B / Tier 4i	HC	187026	187027	187028	187029

Hydraulic Oil Filtration Hydraulikölfiltration

VF: standard HC: HydroClean
VF: Standard HC: HydroClean

Water Separator Wasserabscheider

WA: standard WAH: heatable
WA: Standard WAH: beheizbar



Inspection Sets Inspektionssätze

Model Modell	Emission Standard Abgasnorm	VF WA	VF WAH	HC WA	HC WAH
875E	EU Stage III B / Tier 4i	No. Nr.	No. Nr.	No. Nr.	No. Nr.
		187030			

1.1 SERVICE & RETROFIT KITS / SERVICE & NACHRÜSTSÄTZE

875E Undercarriage / Unterwagen

Model <i>Modell</i>	PLN <i>PLN</i>	Description <i>Bezeichnung</i>	No. <i>Nr.</i>
875E	---	---	---

875E Uppercarriage / Oberwagen

Model <i>Modell</i>	PLN <i>PLN</i>	Description <i>Bezeichnung</i>	No. <i>Nr.</i>
875E	---	---	---

875E Boom / Ausleger

Model <i>Modell</i>	PLN <i>PLN</i>	Description <i>Bezeichnung</i>	No. <i>Nr.</i>
875E	---	---	---

875E Lights & Travel Alarm / Beleuchtung & Fahralarm

Model <i>Modell</i>	PLN <i>PLN</i>	Description <i>Bezeichnung</i>	No. <i>Nr.</i>
875E	---	---	---

875E Camera Packages / Kamerapakete

Model <i>Modell</i>	PLN <i>PLN</i>	Description <i>Bezeichnung</i>	No. <i>Nr.</i>
875E	PLN 14661	Camera system – view under cabin <i>Kamerasystem für Kabinenunterbodenüberwachung</i>	260160

875E Functions / Funktionen

Model <i>Modell</i>	PLN <i>PLN</i>	Description <i>Bezeichnung</i>	No. <i>Nr.</i>
875E	PLN 15319	SENtrack DS (Diesel, E-Series) for SENCON 1 <i>SENtrack DS (Diesel, E-Serie) für SENCON 1</i>	265783
875E	PLN 15319	SENtrack DS (Diesel, E-Series) for SENCON 2 <i>SENtrack DS (Diesel, E-Serie) für SENCON 2</i>	265782

1.1 SERVICE & RETROFIT KITS / SERVICE & NACHRÜSTSÄTZE

608D Service Packages / Inspections Sets Service-Pakete / Inspektionssätze

Service Intervals Serviceintervalle

Operating hours / Betriebsstunden	6000	3
	5500	1
	5000	2
	4500	1
	4000	3
	3500	1
	3000	2
	2500	1
	2000	3
	1500	1
	1000	2
	500	1
	250	A



7,0%
Price Advantage
Preisvorteil

Service Packages Service-Pakete

Model Modell	Emission Standard Abgasnorm	Configuration Ausstattung	No. Nr.	No. Nr.	No. Nr.	No. Nr.
608D	EU Stage III A / Tier 3	VF WA	182374	182392	182402	182557
		VF WAH	182374	187031	187032	187033
		HC WA	182375	182392	182402	182558
		HC WAH	182375	187031	187032	187034

Hydraulic Oil Filtration Hydraulikölfiltration

VF: standard HC: HydroClean
VF: Standard HC: HydroClean

Water Separator Wasserabscheider

WA: standard WAH: heatable
WA: Standard WAH: beheizbar

Inspection Sets Inspektionssätze

Model Modell	Emission Standard Abgasnorm	No. Nr.	No. Nr.	No. Nr.	No. Nr.
608D	EU Stage III A / Tier 3	162787	162788	162789	162790

20%
Price Advantage
Preisvorteil

1.1 SERVICE & RETROFIT KITS / SERVICE & NACHRÜSTSÄTZE

613D Service Packages / Inspections Sets

Service-Pakete / Inspektionssätze

Service Intervals Serviceintervalle

Operating hours / Betriebsstunden	6000	3
	5500	1
	5000	2
	4500	1
	4000	3
	3500	1
	3000	2
	2500	1
	2000	3
	1500	1
	1000	2
	500	1
	250	A



Service Packages Service-Pakete

Model Modell	Emission Standard Abgasnorm	Configuration Ausstattung	No. Nr.	No. Nr.	No. Nr.	No. Nr.
613D	EU Stage III A / Tier 3	VF WA	182374	182392	182402	182557
		VF WAH	182374	187031	187032	187033
		HC WA	182375	182392	182402	182558
		HC WAH	182375	187031	187032	187034

Hydraulic Oil Filtration Hydraulikölfiltration

VF: standard HC: HydroClean
VF: Standard HC: HydroClean

Water Separator Wasserabscheider

WA: standard WAH: heatable
WA: Standard WAH: beheizbar

Inspection Sets Inspektionssätze

Model Modell	Emission Standard Abgasnorm	No. Nr.	No. Nr.	No. Nr.	No. Nr.
613D	EU Stage III A / Tier 3	162787	162788	162789	162790



1.1 SERVICE & RETROFIT KITS / SERVICE & NACHRÜSTSÄTZE

613E Service Packages / Inspections Sets / Retrofit Kits Service-Pakete / Inspektionssätze / Nachrüstätze

Service Intervals Serviceintervalle

Operating hours / Betriebsstunden	6000	3
	5500	1
	5000	2
	4500	1
	4000	3
	3500	1
	3000	2
	2500	1
	2000	3
	1500	1
	1000	2
	500	1
	250	A



Service Packages Service-Pakete

		A	1	2	3	
Model Modell	Emission Standard Abgasnorm	No. Nr.	No. Nr.	No. Nr.	No. Nr.	
613E	EU Stage III A / Tier 3	VF	238429	238431	238433	238435
		HC	238430	238431	238433	238436
	EU Stage IV / Tier 4f	VF	225359	225360	225361	225362
	up to / bis 613.x.1065	HC	225363	225360	225361	225366
	EU Stage IV / Tier 4f	VF	225359	263771	263772	263775
	from / ab 613.x.1066	HC	225363	263771	263772	263777
		VF	-	-	-	-
	EU Stage V / Tier 4f	HC	267081	267082	267083	267085

Hydraulic Oil Filtration Hydraulikölfiltration

VF: standard HC: HydroClean
VF: Standard HC: HydroClean

Water Separator Wasserabscheider

WA: standard WAH: heatable
WA: Standard WAH: beheizbar



Inspection Sets Inspektionssätze

		VF WA	VF WAH	HC WA	HC WAH
Model Modell	Emission Standard Abgasnorm	No. Nr.	No. Nr.	No. Nr.	No. Nr.
613E	EU Stage III A / Tier 3		238437		238438
	EU Stage IV / Tier 4f up to / bis 613.x.1065		225371		225378
	EU Stage IV / Tier 4f from / ab 613.x.1066		263778		263781
	EU Stage V / Tier 4f		-		267086

1.1 SERVICE & RETROFIT KITS / SERVICE & NACHRÜSTSÄTZE

613E Undercarriage / Unterwagen

Model Modell	PLN PLN	Description Bezeichnung	No. Nr.
613E	PLN 16770	Hitch (up to 200 Kn pulling force, no vertical load) for wheeled machine <i>Rangierkupplung (bis max. 200 Kn Zugkraft, keine Stützlast) für Mobilgerät</i>	271573

613E Uppercarriage / Oberwagen

Model Modell	PLN PLN	Description Bezeichnung	No. Nr.
613E	PLN 1695	SENNEBOGEN Hydro Clean <i>SENNEBOGEN Hydro Clean</i>	271574
613E	PLN 14104	Electric-hydraulic emergency unit 2 kW <i>Elektrohydraulisches Notaggregat 2 kW</i>	270149
613E	PLN 2233	Electric refuelling pump (50 l/min) <i>Elektrische Betankungspumpe (50 l/min)</i>	261130

613E Boom / Ausleger

Model Modell	PLN PLN	Description Bezeichnung	No. Nr.
613E	PLN 4255	Working Platform RAL 9005 - fixed <i>Arbeitsplattform RAL 9005 - starr</i>	258522

613E Lights & Travel Alarm / Beleuchtung & Fahralarm

Model Modell	PLN PLN	Description Bezeichnung	No. Nr.
613E	PLN 8414	1 additional LED (24 V / 50 W) headlight mounted on the cab roof, right side, heading backside <i>1 LED Scheinwerfer (24 V / 50 W) auf Kabine rechts hinten</i>	259245
613E	PLN 8415	1 additional LED (24 V / 50 W) headlight mounted on the cab roof, left side, heading backside <i>1 LED Scheinwerfer (24 V / 50 W) auf Kabine links hinten</i>	259245
613E	PLN 12575	1 piece additional LED headlight <i>1 Stück LED Zusatz-Scheinwerfer</i>	259280
613E	PLN 8416	2 LED headlights (24 V / 50 W) mounted on the basic boom <i>2 LED Scheinwerfer (24 V / 50 W) am Grundausleger</i>	259247
613E	PLN 8004	2 LED headlights (24 V / 50 W) mounted swinging on the boom head incl. cable drum <i>2 LED Scheinwerfer (24 V / 50 W) pendelnd am Ausleger inklusive Kabeltrommel</i>	259243
613E	PLN 10748	1 rotating beacon at the cab <i>1 Rundumleuchte an der Kabine</i>	259257
613E	PLN 2450	2 rotating beacons at rear of machine <i>2 Rundumleuchten am Heck des Gerätes</i>	259238

1.1 SERVICE & RETROFIT KITS / SERVICE & NACHRÜSTSÄTZE

613E Camera Packages / Kamerapakete

Model Modell	PLN PLN	Description Bezeichnung	No. Nr.
613E	PLN 14631	Camera system – add-on camera on basic boom (1 piece) <i>Kamerasystem – Erweiterung mit 1 Kamera am Grundausleger</i>	271571

613E Functions / Funktionen

Model Modell	PLN PLN	Description Bezeichnung	No. Nr.
613E	PLN 13642	Complete remote radio control system including beacon for crawler <i>Funkfernsteuerung komplett inkl. Rundumleuchte Raupe</i>	261572
613E	PLN 13642	Complete remote radio control system including beacon for mobile <i>Funkfernsteuerung komplett inkl. Rundumleuchte Mobil</i>	261894
613E	PLN 12252	Limitation of work area – programmable individually <i>Arbeitsbereichsbegrenzung – individuell programmierbar</i>	263342
613E	PLN n/a	SENtrack DS (Diesel, E-Series) for SENCON 2 <i>SENtrack DS (Diesel, E-Series) for SENCON 2</i>	265782

1.1 SERVICE & RETROFIT KITS / SERVICE & NACHRÜSTSÄTZE

633E Service Packages / Inspections Sets / Retrofit Kits Service-Pakete / Inspektionssätze / Nachrüstätze

Service Intervals
Serviceintervalle

Operating hours / Betriebsstunden	6000	3
	5500	1
	5000	2
	4500	1
	4000	3
	3500	1
	3000	2
	2500	1
	2000	3
	1500	1
	1000	2
	500	1
	250	A



Service Packages
Service-Pakete

Model Modell	Emission Standard Abgasnorm	Configuration Ausstattung	A	1	2	3
633E	EU Stage III A / Tier 3	VF	236477	236479	236481	236483
		HC	236478	236479	236481	236484

Hydraulic Oil Filtration
Hydraulikölfiltration

VF: standard HC: HydroClean
VF: Standard HC: HydroClean

Water Separator
Wasserabscheider

WA: standard WAH: heatable
WA: Standard WAH: beheizbar



Inspection Sets
Inspektionssätze

Model Modell	Emission Standard Abgasnorm	VF WA	VF WAH	HC WA	HC WAH
633E	EU Stage III A / Tier 3	No. Nr.	No. Nr.	No. Nr.	No. Nr.
		236485	236485	236485	236486

1.1 SERVICE & RETROFIT KITS / SERVICE & NACHRÜSTSÄTZE

633E Undercarriage / Unterwagen

Model Modell	PLN PLN	Description Bezeichnung	No. Nr.
633E	---	---	---

633E Uppercarriage / Oberwagen

Model Modell	PLN PLN	Description Bezeichnung	No. Nr.
633E	PLN 1695	SENNEBOGEN Hydro Clean <i>SENNEBOGEN Hydro Clean</i>	271568
633E	PLN 13642	Complete remote radio control system including beacon for crawler <i>Funkfernsteuerung komplett inkl. Rundumleuchte für Raupe</i>	261572
633E	PLN 13700	Hand rail at the upper structure on the right side, foldable, 1,100 mm high <i>Geländer am Oberwagen rechte Seite, klappbar, Höhe 1.100 mm</i>	271570
633E	PLN 8466	Automatic central lubrication for telescopic crane <i>Automatische Zentralschmierung Telekran</i>	260344
633E	PLN 2233	Electric refuelling pump (50 l/min) <i>Elektrische Betankungspumpe (50 l/min)</i>	263895

633E Boom / Ausleger

Model Modell	PLN PLN	Description Bezeichnung	No. Nr.
633E	PLN 12698	Wind speed indicator / Anemometer in combination with flight warning light <i>Windmesser / Anemometer kombiniert mit Flugwarnleuchte</i>	270376

633E Lights & Travel Alarm / Beleuchtung & Fahralarm

Model Modell	PLN PLN	Description Bezeichnung	No. Nr.
633E	PLN 8417	2 LED headlights (24 V / 50 W) mounted on both sides at the back of the machine <i>2 LED Scheinwerfer (24 V / 50 W) links und rechts am Oberwagen hinten</i>	271566
633E	PLN 8004	2 LED headlights (24 V / 50 W) mounted swinging on the boom head incl. cable drum <i>2 LED Scheinwerfer (24 V / 50 W) pendelnd am Ausleger inklusive Kabeltrommel</i>	271564
633E	PLN 12088	2 LED headlights mounted on a electrically adjustable traverse <i>2 LED Scheinwerfer mit elektrisch verstellbarer Traverse montiert</i>	282655
633E	PLN 2450	2 rotating beacons at rear of machine <i>2 Rundumleuchten am Heck des Gerätes</i>	259238
633E	PLN 8414	1 additional LED (24 V / 50 W) headlight mounted on the cab roof, right side, heading backside <i>1 LED Scheinwerfer (24 V / 50 W) auf Kabine rechts hinten</i>	259245
633E	PLN 8415	1 additional LED (24 V / 50 W) headlight mounted on the cab roof, left side, heading backside <i>1 LED Scheinwerfer (24 V / 50 W) auf Kabine links hinten</i>	259245
633E	PLN 10748	1 rotating beacon at the cab <i>1 Rundumleuchte an der Kabine</i>	259257
633E	PLN 8416	2 LED headlights (24 V / 50 W) mounted on the basic boom <i>2 LED Scheinwerfer (24 V / 50 W) am Grundaussleger</i>	269809

1.1 SERVICE & RETROFIT KITS / SERVICE & NACHRÜSTSÄTZE

633E Camera Packages / Kamerapakete

Model <i>Modell</i>	PLN <i>PLN</i>	Description <i>Bezeichnung</i>	No. <i>Nr.</i>
633E	---	---	---

633E Functions / Funktionen

Model <i>Modell</i>	PLN <i>PLN</i>	Description <i>Bezeichnung</i>	No. <i>Nr.</i>
633E	PLN 12252	Limitation of work area - programmable individually <i>Arbeitsbereichsbegrenzung - individuell programmierbar</i>	267113
633E	PLN n/a	SENtrack DS (Diesel, E-Series) for SENCON 2 <i>SENtrack DS (Diesel, E-Serie) für SENCON 2</i>	265782

1.1 SERVICE & RETROFIT KITS / SERVICE & NACHRÜSTSÄTZE

643E Service Packages / Inspections Sets / Retrofit Kits Service-Pakete / Inspektionssätze / Nachrüstätze

Service Intervals Serviceintervalle

Operating hours / Betriebsstunden	6000	3
	5500	1
	5000	2
	4500	1
	4000	3
	3500	1
	3000	2
	2500	1
	2000	3
	1500	1
	1000	2
	500	1
	250	A



7,0%
Price Advantage
Preisvorteil

Service Packages Service-Pakete

Model Modell	Emission Standard Abgasnorm	Configuration Ausstattung	No. Nr.	No. Nr.	No. Nr.	No. Nr.
643E	EU Stage III A / Tier 3	VF	236477	238545	238548	238550
		HC	236478	238545	238548	238551
	EU Stage IV / Tier 4f	VF	238555	236458	238558	238559
		HC	238556	236458	238558	238560

Hydraulic Oil Filtration Hydraulikölfiltration

VF: standard HC: HydroClean
VF: Standard HC: HydroClean

Water Separator Wasserabscheider

WA: standard WAH: heatable
WA: Standard WAH: beheizbar

Inspection Sets Inspektionssätze

20%
Price Advantage
Preisvorteil

Model Modell	Emission Standard Abgasnorm	No. Nr.	No. Nr.	No. Nr.	No. Nr.
643E	EU Stage III A / Tier 3		238552		238553
	EU Stage IV / Tier 4f		238561		238562

1.1 SERVICE & RETROFIT KITS / SERVICE & NACHRÜSTSÄTZE

643E Undercarriage / Unterwagen

Model Modell	PLN PLN	Description Bezeichnung	No. Nr.
643E	---	---	---

643E Uppercarriage / Oberwagen

Model Modell	PLN PLN	Description Bezeichnung	No. Nr.
643E	PLN 1695	SENNEBOGEN Hydro Clean Mobile <i>SENNEBOGEN Hydro Clean Mobil</i>	282650
643E	PLN 1695	SENNEBOGEN Hydro Clean Crawler <i>SENNEBOGEN Hydro Clean Raupe</i>	271568
643E	PLN 13642	Complete remote radio control system including beacon for crawler <i>Funkfernsteuerung komplett inkl. Rundumleuchte Raupe</i>	261572
643E	PLN 13642	Complete remote radio control system including beacon for mobile <i>Funkfernsteuerung komplett inkl. Rundumleuchte Mobil</i>	261894
643E	PLN 2233	Electric refuelling pump (50 l/min) <i>Elektrische Betankungspumpe (50 l/min)</i>	263895
643E	PLN 13700	Hand rail at the upper structure on the right side, foldable, 1,100 mm high <i>Geländer am Oberwagen rechte Seite, klappbar, Höhe 1.100 mm</i>	271570

643E Boom / Ausleger

Model Modell	PLN PLN	Description Bezeichnung	No. Nr.
643E	PLN 12698	Wind speed indicator / Anemometer in combination with flight warning light <i>Windmesser / Anemometer kombiniert mit Flugwarnleuchte</i>	270376

643E Lights & Travel Alarm / Beleuchtung & Fahralarm

Model Modell	PLN PLN	Description Bezeichnung	No. Nr.
643E	PLN 12088	2 LED headlights mounted on a electrically adjustable traverse <i>2 LED Scheinwerfer mit elektrisch verstellbarer Traverse montiert</i>	282655
643E	PLN 2450	2 rotating beacons at rear of machine <i>2 Rundumleuchten am Heck des Gerätes</i>	259238
643E	PLN 8414	1 additional LED (24 V / 50 W) headlight mounted on the cab roof, right side, heading backside <i>1 LED Scheinwerfer (24 V / 50 W) auf Kabine rechts hinten</i>	259245
643E	PLN 8415	1 additional LED (24 V / 50 W) headlight mounted on the cab roof, left side, heading backside <i>1 LED Scheinwerfer (24 V / 50 W) auf Kabine links hinten</i>	259245
643E	PLN 10748	1 rotating beacon at the cab <i>1 Rundumleuchte an der Kabine</i>	259257
643E	PLN 8416	2 LED headlights (24 V / 50 W) mounted on the basic boom <i>2 LED Scheinwerfer (24 V / 50 W) am Grundaussleger</i>	269809

1.1 SERVICE & RETROFIT KITS / SERVICE & NACHRÜSTSÄTZE

Model Modell	PLN PLN	Description Bezeichnung	No. Nr.
643E	PLN 8004	2 LED headlights (24 V / 50 W) mounted swinging on the boom head incl. cable drum <i>2 LED Scheinwerfer (24 V / 50 W) pendelnd am Ausleger inklusive Kabeltrommel</i>	271564
643E	PLN 8417	2 LED headlights (24 V / 50 W) mounted on both sides at the back of the machine <i>2 LED Scheinwerfer (24 V / 50 W) links und rechts am Oberwagen hinten</i>	271566

643E Camera Packages / Kamerapakete

Model Modell	PLN PLN	Description Bezeichnung	No. Nr.
643E	PLN 14631	Camera system – add-on camera on basic boom (1 piece) <i>Kamerasystem – Erweiterung mit 1 Kamera am Grundausleger</i>	282653

643E Functions / Funktionen

Model Modell	PLN PLN	Description Bezeichnung	No. Nr.
643E	PLN n/a	SENtrack DS (Diesel, E-Series) for SENCON 2 <i>SENtrack DS (Diesel, E-Serie) für SENCON 2</i>	265782

1.1 SERVICE & RETROFIT KITS / SERVICE & NACHRÜSTSÄTZE

653E

Service Packages / Inspections Sets / Retrofit Kits
Service-Pakete / Inspektionssätze / Nachrüstätze

Service Intervals
Serviceintervalle

6000	3
5500	1
5000	2
4500	1
4000	3
3500	1
3000	2
2500	1
2000	3
1500	1
1000	2
500	1
250	A

Operating hours / Betriebsstunden



7,0%
Price Advantage
Preisvorteil

Service Packages Service-Pakete			A	1	2	3
Model Modell	Emission Standard Abgasnorm	Configuration Ausstattung	No. Nr.	No. Nr.	No. Nr.	No. Nr.
653E	EU Stage III A / Tier 3	VF	236495	236479	236498	236499
		HC	236496	236479	236498	236500
	EU Stage IV / Tier 4f	VF	232249	186442	222345	232250
		HC	222344	186442	222345	222346

Hydraulic Oil Filtration
Hydraulikölfiltration

VF: standard HC: HydroClean
VF: Standard HC: HydroClean

Water Separator
Wasserabscheider

WA: standard WAH: heatable
WA: Standard WAH: beheizbar

20%
Price Advantage
Preisvorteil

Inspection Sets Inspektionssätze		VF	VF	HC	HC
		WA	WAH	WA	WAH
Model Modell	Emission Standard Abgasnorm	No. Nr.	No. Nr.	No. Nr.	No. Nr.
653E	EU Stage III A / Tier 3		236501		236502
	EU Stage IV / Tier 4f		232251		222347

1.1 SERVICE & RETROFIT KITS / SERVICE & NACHRÜSTSÄTZE

653E Undercarriage / Unterwagen

Model Modell	PLN PLN	Description Bezeichnung	No. Nr.
653E	---	---	---

653E Uppercarriage / Oberwagen

Model Modell	PLN PLN	Description Bezeichnung	No. Nr.
653E	PLN 1695	SENNEBOGEN Hydro Clean <i>SENNEBOGEN Hydro Clean</i>	282658
653E	PLN 13642	Complete remote radio control system including beacon for crawler <i>Funkfernsteuerung komplett inkl. Rundumleuchte für Raupe</i>	261572
653E	PLN 8466	Automatic central lubrication for telescopic crane <i>Automatische Zentralschmierung Telekran</i>	260344
653E	PLN 2233	Electric refuelling pump (50 l/min) <i>Elektrische Betankungspumpe (50 l/min)</i>	263895
653E	PLN 13700	Hand rail at the upper structure on the right side, foldable, 1,100 mm high <i>Geländer am Oberwagen rechte Seite, klappbar, Höhe 1.100 mm</i>	271570

653E Boom / Ausleger

Model Modell	PLN PLN	Description Bezeichnung	No. Nr.
653E	PLN 12698	Wind speed indicator / Anemometer in combination with flight warning light <i>Windmesser / Anemometer kombiniert mit Flugwarnleuchte</i>	270376

653E Lights & Travel Alarm / Beleuchtung & Fahralarm

Model Modell	PLN PLN	Description Bezeichnung	No. Nr.
653E	PLN 12088	2 LED headlights mounted on a electrically adjustable traverse <i>2 LED Scheinwerfer mit elektrisch verstellbarer Traverse montiert</i>	282655
653E	PLN 2450	2 rotating beacons at rear of machine <i>2 Rundumleuchten am Heck des Gerätes</i>	259238
653E	PLN 8414	1 additional LED (24 V / 50 W) headlight mounted on the cab roof, right side, heading backside <i>1 LED Scheinwerfer (24 V / 50 W) auf Kabine rechts hinten</i>	259245
653E	PLN 8415	1 additional LED (24 V / 50 W) headlight mounted on the cab roof, left side, heading backside <i>1 LED Scheinwerfer (24 V / 50 W) auf Kabine links hinten</i>	259245
653E	PLN 10748	1 rotating beacon at the cab <i>1 Rundumleuchte an der Kabine</i>	259259
653E	PLN 12575	1 piece additional LED headlight <i>1 Stück LED Zusatz-Scheinwerfer</i>	259280

1.1 SERVICE & RETROFIT KITS / SERVICE & NACHRÜSTSÄTZE

Model Modell	PLN PLN	Description Bezeichnung	No. Nr.
653E	PLN 8416	2 LED headlights (24 V / 50 W) mounted on the basic boom <i>2 LED Scheinwerfer (24 V / 50 W) am Grundausleger</i>	269809
653E	PLN 8004	2 LED headlights (24 V / 50 W) mounted swinging on the boom head incl. cable drum <i>2 LED Scheinwerfer (24 V / 50 W) pendelnd am Ausleger inklusive Kabeltrommel</i>	271564
653E	PLN 8417	2 LED headlights (24 V / 50 W) mounted on both sides at the back of the machine <i>2 LED Scheinwerfer (24 V / 50 W) links und rechts am Oberwagen hinten</i>	271566

653E Camera Packages / Kamerapakete

Model Modell	PLN PLN	Description Bezeichnung	No. Nr.
653E	PLN 14631	Camera system – add-on camera on basic boom (1 piece) <i>Kamerasystem – Erweiterung mit 1 Kamera am Grundausleger</i>	282661

653E Functions / Funktionen

Model Modell	PLN PLN	Description Bezeichnung	No. Nr.
653E	PLN 12252	Limitation of work area – programmable individually <i>Arbeitsbereichsbegrenzung – individuell programmierbar</i>	267113
653E	PLN n/a	SENtrack DS (Diesel, E-Series) for SENCON 2 <i>SENtrack DS (Diesel, E-Serie) für SENCON 2</i>	265782

1.1 SERVICE & RETROFIT KITS / SERVICE & NACHRÜSTSÄTZE

673E Service Packages / Inspections Sets / Retrofit Kits Service-Pakete / Inspektionssätze / Nachrüstätze

Service Intervals Serviceintervalle

Operating hours / Betriebsstunden	6000	3
	5500	1
	5000	2
	4500	1
	4000	3
	3500	1
	3000	2
	2500	1
	2000	3
	1500	1
	1000	2
	500	1
	250	A



7,0%
Price Advantage
Preisvorteil

Service Packages Service-Pakete

Model Modell	Emission Standard Abgasnorm	Configuration Ausstattung	A	1	2	3
673E	EU Stage III A / Tier 3	VF	236487	236479	236490	236491
		HC	236488	236479	236490	236492
	EU Stage IV / Tier 4f	VF	232252	186442	186443	232253
		HC	186441	186442	186443	186444

Hydraulic Oil Filtration Hydraulikölfiltration

VF: standard HC: HydroClean
VF: Standard HC: HydroClean

Water Separator Wasserabscheider

WA: standard WAH: heatable
WA: Standard WAH: beheizbar

Inspection Sets Inspektionssätze

20%
Price Advantage
Preisvorteil

Model Modell	Emission Standard Abgasnorm	VF WA	VF WAH	HC WA	HC WAH
673E	EU Stage III A / Tier 3	No. Nr.	No. Nr.	No. Nr.	No. Nr.
	EU Stage IV / Tier 4f		236493		236494
			232254		186440

1.1 SERVICE & RETROFIT KITS / SERVICE & NACHRÜSTSÄTZE

673E Undercarriage / Unterwagen

Model Modell	PLN PLN	Description Bezeichnung	No. Nr.
673E	---	---	---

673E Uppercarriage / Oberwagen

Model Modell	PLN PLN	Description Bezeichnung	No. Nr.
673E	PLN 1695	SENNEBOGEN Hydro Clean <i>SENNEBOGEN Hydro Clean</i>	283695
673E	PLN 8466	Automatic central lubrication for telescopic crane <i>Automatische Zentralschmierung Telekran</i>	282666
673E	PLN 13642	Complete remote radio control system including beacon for crawler <i>Funkfernsteuerung komplett inkl. Rundumleuchte Raupe</i>	261572
673E	PLN 2233	Electric refuelling pump (50 l/min) <i>Elektrische Betankungspumpe (50 l/min)</i>	269804

673E Boom / Ausleger

Model Modell	PLN PLN	Description Bezeichnung	No. Nr.
673E	PLN 12698	Wind speed indicator / Anemometer in combination with flight warning light <i>Windmesser / Anemometer kombiniert mit Flugwarnleuchte</i>	282668

673E Lights & Travel Alarm / Beleuchtung & Fahralarm

Model Modell	PLN PLN	Description Bezeichnung	No. Nr.
673E	PLN 12088	2 LED headlights mounted on a electrically adjustable traverse <i>2 LED Scheinwerfer mit elektrisch verstellbarer Traverse montiert</i>	282655
673E	PLN 8417	2 LED headlights (24 V / 50 W) mounted on both sides at the back of the machine <i>2 LED Scheinwerfer (24 V / 50 W) links und rechts am Oberwagen hinten</i>	282673
673E	PLN 8004	2 LED headlights (24 V / 50 W) mounted swinging on the boom head incl. cable drum <i>2 LED Scheinwerfer (24 V / 50 W) pendelnd am Ausleger inklusive Kabeltrommel</i>	282675
673E	PLN 2450	2 rotating beacons at rear of machine <i>2 Rundumleuchten am Heck des Gerätes</i>	259238
673E	PLN 8414	1 additional LED (24 V / 50 W) headlight mounted on the cab roof, right side, heading backside <i>1 LED Scheinwerfer (24 V / 50 W) auf Kabine rechts hinten</i>	259245
673E	PLN 8415	1 additional LED (24 V / 50 W) headlight mounted on the cab roof, left side, heading backside <i>1 LED Scheinwerfer (24 V / 50 W) auf Kabine links hinten</i>	259245
673E	PLN 10748	1 rotating beacon at the cab <i>1 Rundumleuchte an der Kabine</i>	259259
673E	PLN 8416	2 LED headlights (24 V / 50 W) mounted on the basic boom <i>2 LED Scheinwerfer (24 V / 50 W) am Grundaussleger</i>	269809

1.1 SERVICE & RETROFIT KITS / SERVICE & NACHRÜSTSÄTZE

673E Camera Packages / Kamerapakete

Model <i>Modell</i>	PLN <i>PLN</i>	Description <i>Bezeichnung</i>	No. <i>Nr.</i>
673E	---	---	---

673E Functions / Funktionen

Model <i>Modell</i>	PLN <i>PLN</i>	Description <i>Bezeichnung</i>	No. <i>Nr.</i>
673E	PLN 12252	Limitation of work area - programmable individually <i>Arbeitsbereichsbegrenzung - individuell programmierbar</i>	282671
673E	PLN n/a	SENtrack DS (Diesel, E-Series) for SENCON 2 <i>SENtrack DS (Diesel, E-Serie) für SENCON 2</i>	265782

1.1 SERVICE & RETROFIT KITS / SERVICE & NACHRÜSTSÄTZE

683 Service Packages / Inspections Sets

Service-Pakete / Inspektionssätze

Service Intervals
Serviceintervalle

6000	3
5500	1
5000	2
4500	1
4000	3
3500	1
3000	2
2500	1
2000	3
1500	1
1000	2
500	1
250	A

Operating hours / Betriebsstunden



7,0%
Price Advantage
Preisvorteil

Service Packages Service-Pakete		A	1	2	3	
Model Modell	Emission Standard Abgasnorm	No. Nr.	No. Nr.	No. Nr.	No. Nr.	
683	EU Stage III A / Tier 3	VF WA	182380	182395	182405	182563
		VF WAH	182380	187039	187040	187041
		HC WA	182381	182395	182405	182564
		HC WAH	182381	187039	187040	187042

Hydraulic Oil Filtration
Hydraulikölfiltration

VF: standard HC: HydroClean
VF: Standard HC: HydroClean

Water Separator
Wasserabscheider

WA: standard WAH: heatable
WA: Standard WAH: beheizbar

20%
Price Advantage
Preisvorteil

Inspection Sets Inspektionssätze		VF WA	VF WAH	HC WA	HC WAH
Model Modell	Emission Standard Abgasnorm	No. Nr.	No. Nr.	No. Nr.	No. Nr.
683	EU Stage III A / Tier 3	162800	162801	162802	162803

1.1 SERVICE & RETROFIT KITS / SERVICE & NACHRÜSTSÄTZE

6113E Service Packages / Inspections Sets / Retrofit Kits Service-Pakete / Inspektionssätze / Nachrüstätze

Service Intervals Serviceintervalle

Operating hours / Betriebsstunden	6000	3
	5500	1
	5000	2
	4500	1
	4000	3
	3500	1
	3000	2
	2500	1
	2000	3
	1500	1
	1000	2
	500	1
	250	A



7,0%
Price Advantage
Preisvorteil

Service Packages Service-Pakete

		A	1	2	3	
Model Modell	Emission Standard Abgasnorm	Configuration Ausstattung	No. Nr.	No. Nr.	No. Nr.	No. Nr.
6113E	EU Stage III A / Tier 3	VF	242395	242397	242398	242399
		HC	242396	242397	242398	242400
	EU Stage IV / Tier 4f	VF	242486	242507	242508	242509
		HC	242505	242507	242508	242510

Hydraulic Oil Filtration Hydraulikölfiltration

VF: standard HC: HydroClean
VF: Standard HC: HydroClean

Water Separator Wasserabscheider

WA: standard WAH: heatable
WA: Standard WAH: beheizbar

Inspection Sets Inspektionssätze

20%
Price Advantage
Preisvorteil

		VF WA	VF WAH	HC WA	HC WAH
Model Modell	Emission Standard Abgasnorm	No. Nr.	No. Nr.	No. Nr.	No. Nr.
6113E	EU Stage III A / Tier 3		242402		242403
	EU Stage IV / Tier 4f		242539		242527

1.1 SERVICE & RETROFIT KITS / SERVICE & NACHRÜSTSÄTZE

6113E Undercarriage / Unterwagen

Model Modell	PLN PLN	Description Bezeichnung	No. Nr.
6113E	---	---	---

6113E Uppercarriage / Oberwagen

Model Modell	PLN PLN	Description Bezeichnung	No. Nr.
6113E	PLN 1695	SENNEBOGEN Hydro Clean <i>SENNEBOGEN Hydro Clean</i>	282663
6113E	PLN 8466	Automatic central lubrication for telescopic crane <i>Automatische Zentralschmierung Telekran</i>	282677
6113E	PLN 2233	Electric refuelling pump (50 l/min) <i>Elektrische Betankungspumpe (50 l/min)</i>	282682
6113E	PLN 13642	Complete remote radio control system including beacon for mobile <i>Funkfernsteuerung komplett inkl. Rundumleuchte für Mobil</i>	261894
6113E	PLN 13642	Complete remote radio control system including beacon for crawler <i>Funkfernsteuerung komplett inkl. Rundumleuchte für Raupe</i>	261572

6113E Boom / Ausleger

Model Modell	PLN PLN	Description Bezeichnung	No. Nr.
6113E	PLN 12698	Wind speed indicator / Anemometer in combination with flight warning light <i>Windmesser / Anemometer kombiniert mit Flugwarnleuchte</i>	282668
6113E	PLN 12697	Wind speed indicator / Anemometer <i>Windmesser / Anemometer</i>	282679

6113E Lights & Travel Alarm / Beleuchtung & Fahralarm

Model Modell	PLN PLN	Description Bezeichnung	No. Nr.
6113E	PLN 12088	2 LED headlights mounted on a electrically adjustable traverse <i>2 LED Scheinwerfer mit elektrisch verstellbarer Traverse montiert</i>	282655
6113E	PLN 8004	2 LED headlights (24 V / 50 W) mounted swinging on the boom head incl. cable drum <i>2 LED Scheinwerfer (24 V / 50 W) pendelnd am Ausleger inklusive Kabeltrommel</i>	282685
6113E	PLN 2450	2 rotating beacons at rear of machine <i>2 Rundumleuchten am Heck des Gerätes</i>	259238
6113E	PLN 8414	1 additional LED (24 V / 50 W) headlight mounted on the cab roof, right side, heading backside <i>1 LED Scheinwerfer (24 V / 50 W) auf Kabine rechts hinten</i>	259245
6113E	PLN 8415	1 additional LED (24 V / 50 W) headlight mounted on the cab roof, left side, heading backside <i>1 LED Scheinwerfer (24 V / 50 W) auf Kabine links hinten</i>	259245
6113E	PLN 10748	1 rotating beacon at the cab <i>1 Rundumleuchte an der Kabine</i>	259259

1.1 SERVICE & RETROFIT KITS / SERVICE & NACHRÜSTSÄTZE

Model Modell	PLN PLN	Description Bezeichnung	No. Nr.
6113E	PLN 8416	2 LED headlights (24 V / 50 W) mounted on the basic boom <i>2 LED Scheinwerfer (24 V / 50 W) am Grundausleger</i>	269809
6113E	PLN 8417	2 LED headlights (24 V / 50 W) mounted on both sides at the back of the machine <i>2 LED Scheinwerfer (24 V / 50 W) links und rechts am Oberwagen hinten</i>	271566

6113E Camera Packages / Kamerapakete

Model Modell	PLN PLN	Description Bezeichnung	No. Nr.
6113E	---	---	---

6113E Functions / Funktionen

Model Modell	PLN PLN	Description Bezeichnung	No. Nr.
6113E	PLN 12252	Limitation of work area – programmable individually <i>Arbeitsbereichsbegrenzung – individuell programmierbar</i>	269806

1.1 SERVICE & RETROFIT KITS / SERVICE & NACHRÜSTSÄTZE

630D

Service Packages / Inspections Sets
Service-Pakete / Inspektionssätze

Service Intervals
Serviceintervalle

Operating hours / Betriebsstunden	6000	3
	5500	1
	5000	2
	4500	1
	4000	3
	3500	1
	3000	2
	2500	1
	2000	3
	1500	1
	1000	2
	500	1
	250	A



Service Packages
Service-Pakete

	A	1	2	3
Model Modell				
Emission Standard Abgasnorm				
Configuration Ausstattung				
No. Nr.				
630D				

Hydraulic Oil Filtration
Hydraulikölfiltration

VF: standard HC: HydroClean
VF: Standard HC: HydroClean

Water Separator
Wasserabscheider

WA: standard WAH: heatable
WA: Standard WAH: beheizbar

Inspection Sets
Inspektionssätze



	VF	VF	HC	HC
	WA	WAH	WA	WAH
Model Modell				
Emission Standard Abgasnorm				
No. Nr.				
630D				

1.1 SERVICE & RETROFIT KITS / SERVICE & NACHRÜSTSÄTZE

640E Service Packages / Inspections Sets Service-Pakete / Inspektionssätze

Service Intervals Serviceintervalle

Operating hours / Betriebsstunden	6000	3
	5500	1
	5000	2
	4500	1
	4000	3
	3500	1
	3000	2
	2500	1
	2000	3
	1500	1
	1000	2
	500	1
	250	A



7,0%
Price Advantage
Preisvorteil

Service Packages Service-Pakete

Model Modell	Emission Standard Abgasnorm	Configuration Ausstattung	No. Nr.	No. Nr.	No. Nr.	No. Nr.
640E	EU Stage III A / Tier 3	HC	217278	217279	217280	217281
	EU Stage IV / Tier 4f	HC	217278	217283	217284	217285

Hydraulic Oil Filtration Hydraulikölfiltration

VF: standard HC: HydroClean
VF: Standard HC: HydroClean

Water Separator Wasserabscheider

WA: standard WAH: heatable
WA: Standard WAH: beheizbar

Inspection Sets Inspektionssätze

Model Modell	Emission Standard Abgasnorm	No. Nr.	No. Nr.	No. Nr.	No. Nr.
640E	EU Stage III A / Tier 3	VF WA	VF WAH	HC WA	HC WAH
	EU Stage IV / Tier 4f				

20%
Price Advantage
Preisvorteil

1.1 SERVICE & RETROFIT KITS / SERVICE & NACHRÜSTSÄTZE

1100E Service Packages / Inspections Sets Service-Pakete / Inspektionssätze

Service Intervals
Serviceintervalle

Operating hours / Betriebsstunden	6000	3
	5500	1
	5000	2
	4500	1
	4000	3
	3500	1
	3000	2
	2500	1
	2000	3
	1500	1
	1000	2
	500	1
	250	A



7,0%
Price Advantage
Preisvorteil

Service Packages
Service-Pakete

Model Modell	Emission Standard Abgasnorm	Configuration Ausstattung	A	1	2	3
1100E	EU Stage IV / Tier 4f	VF	236456	236458	236459	236460
		HC	236457	236458	236459	236559

Hydraulic Oil Filtration
Hydraulikölfiltration

VF: standard HC: HydroClean
VF: Standard HC: HydroClean

Water Separator
Wasserabscheider

WA: standard WAH: heatable
WA: Standard WAH: beheizbar

Inspection Sets
Inspektionssätze

20%
Price Advantage
Preisvorteil

Model Modell	Emission Standard Abgasnorm	VF WA	VF WAH	HC WA	HC WAH
1100E	EU Stage IV / Tier 4f	236466	236466	236466	236469

1.1 SERVICE & RETROFIT KITS / SERVICE & NACHRÜSTSÄTZE

2200E Service Packages / Inspections Sets Service-Pakete / Inspektionssätze

Service Intervals Serviceintervalle

Operating hours / Betriebsstunden	6000	3
	5500	1
	5000	2
	4500	1
	4000	3
	3500	1
	3000	2
	2500	1
	2000	3
	1500	1
	1000	2
	500	1
	250	A



7,0%
Price Advantage
Preisvorteil

Service Packages Service-Pakete

Model Modell	Emission Standard Abgasnorm	Configuration Ausstattung	No. Nr.	No. Nr.	No. Nr.	No. Nr.
2200E	EU Stage III A / Tier 3	VF	182384	182397	182406	182565
		HC	182385	182397	182406	182566
	EU Stage IV / Tier 4f	VF	244271	244270	244269	244267
		HC	244272	244270	244269	244268

Hydraulic Oil Filtration Hydraulikölfiltration

VF: standard HC: HydroClean
VF: Standard HC: HydroClean

Water Separator Wasserabscheider

WA: standard WAH: heatable
WA: Standard WAH: beheizbar

Inspection Sets Inspektionssätze

20%
Price Advantage
Preisvorteil

Model Modell	Emission Standard Abgasnorm	No. Nr.	No. Nr.	No. Nr.	No. Nr.
2200E	EU Stage III A / Tier 3		162811		162812
	EU Stage IV / Tier 4f		244265		244266

1.1 SERVICE & RETROFIT KITS / SERVICE & NACHRÜSTSÄTZE

3300E Service Packages / Inspections Sets Service-Pakete / Inspektionssätze

Service Intervals
Serviceintervalle

Operating hours / Betriebsstunden	6000	3
	5500	1
	5000	2
	4500	1
	4000	3
	3500	1
	3000	2
	2500	1
	2000	3
	1500	1
	1000	2
	500	1
	250	A



Service Packages
Service-Pakete

A	1	2	3
---	---	---	---

Model Modell	Emission Standard Abgasnorm	Configuration Ausstattung	No. Nr.	No. Nr.	No. Nr.	No. Nr.
3300E	EU Stage V / Tier 4f	VF	on request / auf Anfrage			
		HC	on request / auf Anfrage			

Hydraulic Oil Filtration
Hydraulikölfiltration

VF: standard HC: HydroClean
VF: Standard HC: HydroClean

Water Separator
Wasserabscheider

WA: standard WAH: heatable
WA: Standard WAH: beheizbar



Inspection Sets
Inspektionssätze

VF	VF	HC	HC
WA	WAH	WA	WAH

Model Modell	Emission Standard Abgasnorm	No. Nr.	No. Nr.	No. Nr.	No. Nr.
3300E	EU Stage V / Tier 4f	on request / auf Anfrage			

1.1 SERVICE & RETROFIT KITS / SERVICE & NACHRÜSTSÄTZE

5500E Service Packages / Inspections Sets Service-Pakete / Inspektionssätze

Service Intervals Serviceintervalle

Operating hours / Betriebsstunden	6000	3
	5500	1
	5000	2
	4500	1
	4000	3
	3500	1
	3000	2
	2500	1
	2000	3
	1500	1
	1000	2
	500	1
	250	A



7,0%
Price Advantage
Preisvorteil

Service Packages Service-Pakete

Model Modell	Emission Standard Abgasnorm	Configuration Ausstattung	No. Nr.	No. Nr.	No. Nr.	No. Nr.
5500E	EU Stage III A / Tier 3	VF	232393	232395	232396	232397
		HC	232394	232395	232396	232398
	EU Stage IV / Tier 4f	VF	231664	231668	231674	231675
		HC	231667	231668	231674	231676

Hydraulic Oil Filtration Hydraulikölfiltration

VF: standard HC: HydroClean
VF: Standard HC: HydroClean

Water Separator Wasserabscheider

WA: standard WAH: heatable
WA: Standard WAH: beheizbar

Inspection Sets Inspektionssätze

20%
Price Advantage
Preisvorteil



Model Modell	Emission Standard Abgasnorm	No. Nr.	No. Nr.	No. Nr.	No. Nr.
5500E	EU Stage III A / Tier 3		232399		232400
	EU Stage IV / Tier 4f		231677		231678

1.2 CAMERAS: SPARE PARTS AND OPTIONS



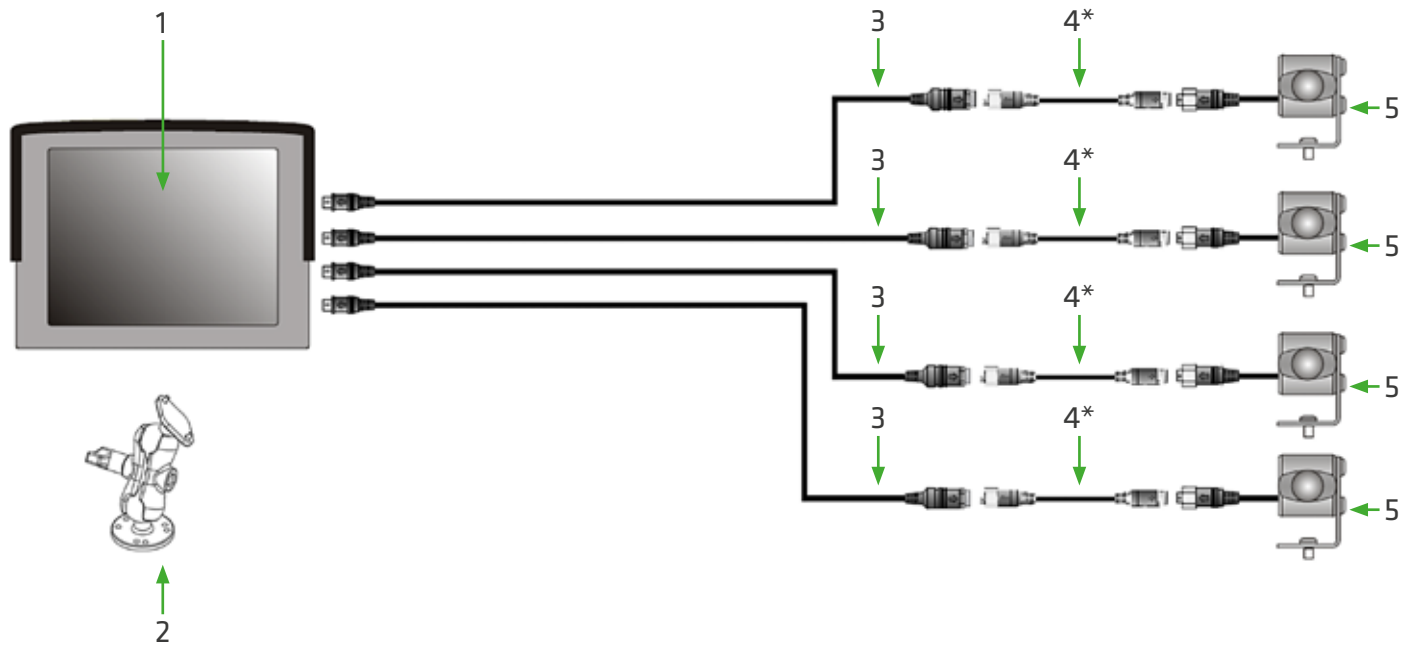

KAMERAS: ERSATZTEILE UND OPTIONEN

Camera without control unit / Kamera ohne Bedieneinheit



	Description <i>Bezeichnung</i>	No. <i>Nr.</i>
1	 Monitor (incl. Protective Cap) <i>Monitor (inkl. Schutzhaube)</i>	149173
2	 Monitor Holder <i>Halter Monitor</i>	206611



1.2 CAMERAS: SPARE PARTS & OPTIONS / KAMERAS: ERSATZTEILE & OPTIONEN

		Description Bezeichnung	No. Nr.
3		System cable camera (5 m) Systemkabel Kamera (5 m)	150483
		System cable camera (7 m) Systemkabel Kamera (7 m)	150484
		System cable camera (10 m) Systemkabel Kamera (10 m)	150485
		System cable camera (15 m) Systemkabel Kamera (15 m)	150486
		System cable camera (20 m) Systemkabel Kamera (20 m)	110217
		System cable camera (25 m) Systemkabel Kamera (25 m)	100352
		System cable camera (30 m) Systemkabel Kamera (30 m)	149175
4		Extension (10 m) - optional* Verlängerung (10 m) - optional*	110225
		Extension (20 m) - optional* Verlängerung (20 m) - optional*	110218
		Extension (30 m) - optional* Verlängerung (30 m) - optional*	150487
5		Camera (incl. Cable and Holder) Kamera (inkl. Kabel und Halter)	159753



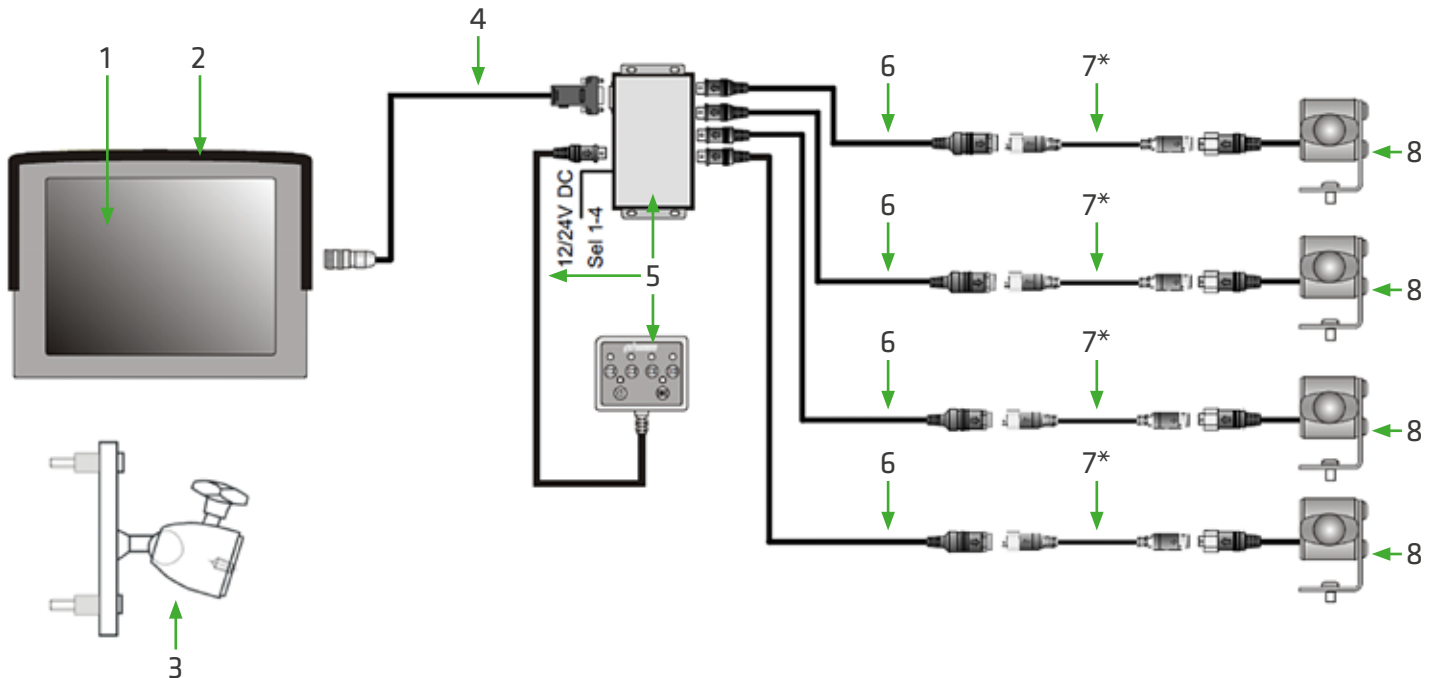









1.2 CAMERAS: SPARE PARTS & OPTIONS / KAMERAS: ERSATZTEILE & OPTIONEN

Camera with control unit / Kamera mit Bedieneinheit



	Description Bezeichnung	No. Nr.
1	 Monitor Monitor	146870
2	 Protective Cap Schutzhaube	146871
3	 Monitor Holder Halter Monitor	146872

1.2 CAMERAS: SPARE PARTS & OPTIONS / KAMERAS: ERSATZTEILE & OPTIONEN

		Description Bezeichnung	No. Nr.
4		Connection cable (5 m) Verbindungskabel (5 m)	146873
5		Control Box Camera System (incl. Cable and Control Device) Umschaltbox Kamerasystem (inkl. Kabel und Bedieneinheit)	148209
6		System cable camera (5 m) Systemkabel Kamera (5 m)	150483
		System cable camera (7 m) Systemkabel Kamera (7 m)	150484
		System cable camera (10 m) Systemkabel Kamera (10 m)	150485
		System cable camera (15 m) Systemkabel Kamera (15 m)	150486
		System cable camera (20 m) Systemkabel Kamera (20 m)	110217
		System cable camera (25 m) Systemkabel Kamera (25 m)	100352
		System cable camera (30 m) Systemkabel Kamera (30 m)	149175
7		Extension (10 m) - optional* Verlängerung (10 m) - optional*	110225
		Extension (20 m) - optional* Verlängerung (20 m) - optional*	110218
		Extension (30 m) - optional* Verlängerung (30 m) - optional*	150487
8		Camera (incl. Cable and Holder) Kamera (inkl. Kabel und Halter)	159753





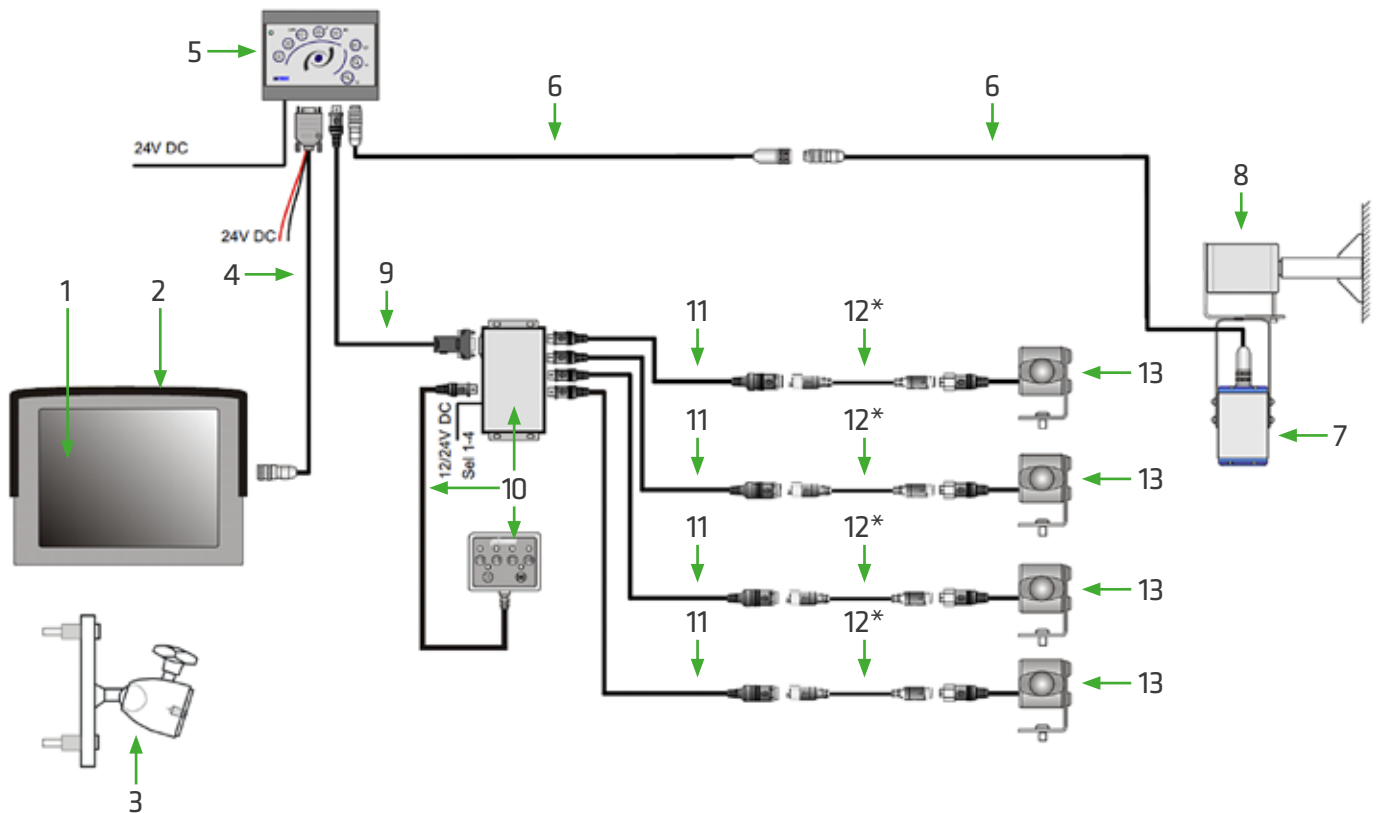

1.2 CAMERAS: SPARE PARTS & OPTIONS / KAMERAS: ERSATZTEILE & OPTIONEN

Camera with control unit and zoom camera /
 Kamera mit Bedieneinheit und Zoom-Kamera















	Description Bezeichnung	No. Nr.
1	 Monitor Monitor	146870
2	 Protective Cap Schutzhaube	146871

1.2 CAMERAS: SPARE PARTS & OPTIONS / KAMERAS: ERSATZTEILE & OPTIONEN

		Description <i>Bezeichnung</i>	No. <i>Nr.</i>
3		Monitor Holder <i>Halter Monitor</i>	146872
4		Connection cable (4 m) <i>Anschlusskabel (4 m)</i>	149607
5		Control Device Zoom Camera <i>Steuergerät Zoomkamera</i>	149608
6		Connection cable (15 m) <i>Verbindungskabel (15 m)</i>	151194
		Connection cable (30 m) <i>Verbindungskabel (30 m)</i>	183806
		Connection cable (60 m) <i>Verbindungskabel (60 m)</i>	149610
7		Zoom Camera <i>Zoomkamera</i>	149613
8		Holder Zoom Camera (oscillating) <i>Halter Zoomkamera (pendelnd)</i>	149611
9		Cable (4m) <i>Kabel (4m)</i>	149609

1.2 CAMERAS: SPARE PARTS & OPTIONS / KAMERAS: ERSATZTEILE & OPTIONEN

		Description Bezeichnung	No. Nr.
10		Control Box Camera System (incl. Cable and Control Device) Umschaltbox Kerasystem (inkl. Kabel und Bedieneinheit)	148209
11		System cable camera (5 m) Systemkabel Kamera (5 m)	150483
		System cable camera (7 m) Systemkabel Kamera (7 m)	150484
		System cable camera (10 m) Systemkabel Kamera (10 m)	150485
		System cable camera (15 m) Systemkabel Kamera (15 m)	150486
		System cable camera (20 m) Systemkabel Kamera (20 m)	110217
		System cable camera (25 m) Systemkabel Kamera (25 m)	100352
		System cable camera (30 m) Systemkabel Kamera (30 m)	149175
12		Extension (10 m) - optional* Verlängerung (10 m) - optional*	110225
		Extension (20 m) - optional* Verlängerung (20 m) - optional*	110218
		Extension (30 m) - optional* Verlängerung (30 m) - optional*	150487
13		Camera (incl. Cable and Holder) Kamera (inkl. Kabel und Halter)	159753

1.2 CAMERAS: SPARE PARTS & OPTIONS / KAMERAS: ERSATZTEILE & OPTIONEN

Mounting Kits for Cameras / Befestigungssätze für Kameras

Description <i>Bezeichnung</i>	No. <i>Nr.</i>
Mounting kit magnetic base (818E - 850E) <i>Befestigungssatz Magnetfuß (818E - 850E)</i>	700290
Mounting kit upper structure right (Greenline E-series, 6113E, 6133E) <i>Befestigungssatz Oberwagen rechts (Greenline E-Serie, 6113E, 6133E)</i>	700241
Mounting kit upper structure right with hand rail (Greenline E-series) <i>Befestigungssatz Oberwagen rechts mit Geländer (Greenline E-Serie)</i>	700153
Mounting kit upper structure right (Greenline) <i>Befestigungssatz Oberwagen rechts (Greenline)</i>	700286
Mounting kit counter weight (Greenline) <i>Befestigungssatz Ballast (Greenline)</i>	700240
Mounting kit upper structure right (673E+) <i>Befestigungssatz Oberwagen rechts (673E+)</i>	245427
Mounting kit Powerpack (Greenline) <i>Befestigungssatz Powerpack (Greenline)</i>	249644
Mounting kit underneath counter weight (6113E, GHC130) <i>Befestigungssatz unter Heckballast (6113E, GHC130)</i>	191822
Mounting kit backup camera underneath counter weight (6113E Mobil) <i>Befestigungssatz Rückfahrkamera Gegengewicht unten (6113E Mobil)</i>	248461

1.3 CABINS: SPARE PARTS AND OPTIONS

KABINEN: ERSATZTEILE UND OPTIONEN

MultiCab 2 / MultiCab 3

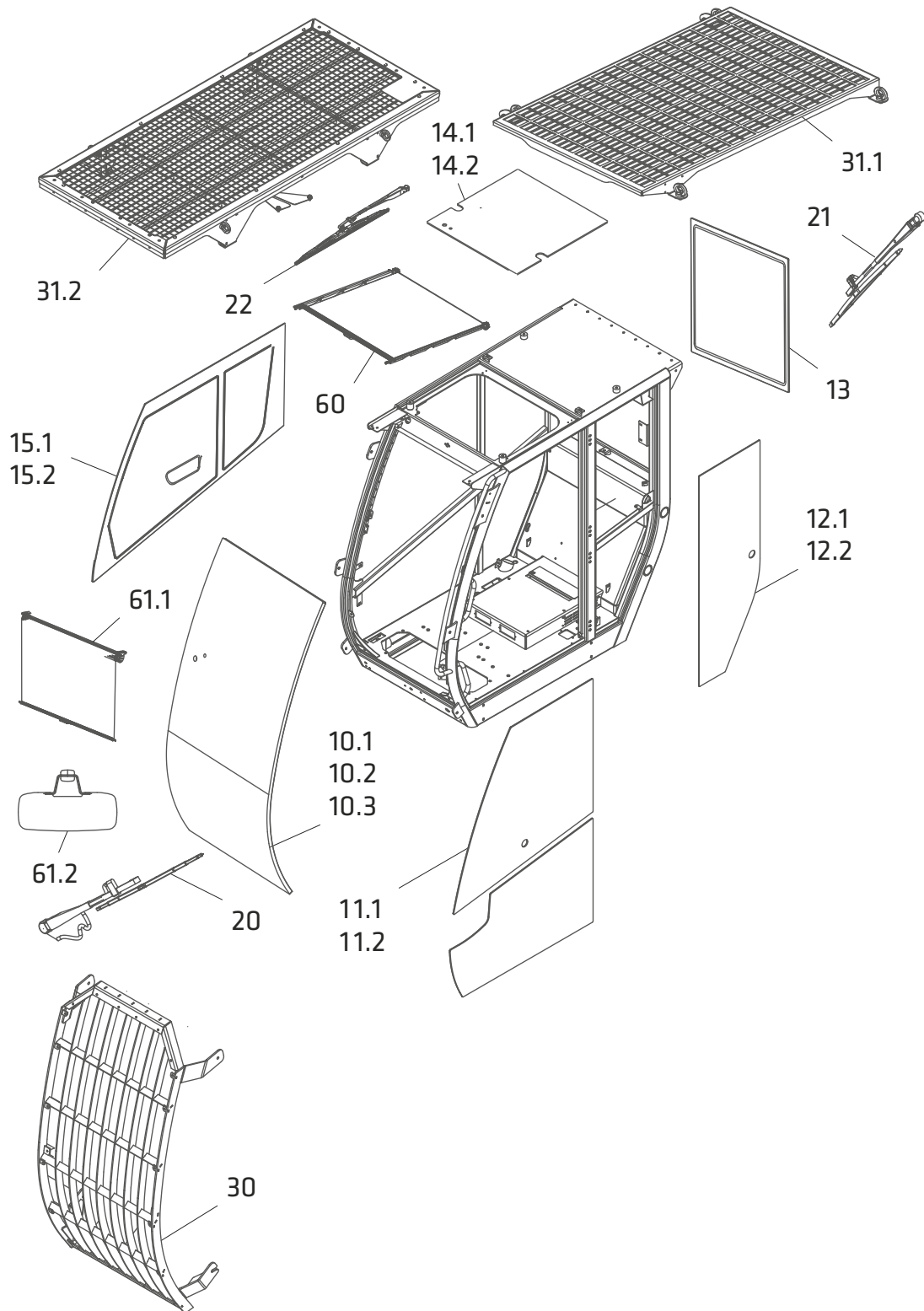

1.3 CABINS: SPARE PARTS AND OPTIONS / KABINEN: ERSATZTEILE UND OPTIONEN

	Description <i>Bezeichnung</i>	No. (MultiCab 2) <i>Nr. (MultiCab 2)</i>	No. (MultiCab 3) <i>Nr. (MultiCab 3)</i>
10.1	Windshield glass, 6 mm, single-pane safety glass <i>Frontscheibe ESG, 6 mm, komplett</i>	209014	246106
10.2	Windshield glass, 18.52 mm, bulletproof glass <i>Frontscheibe Panzerglas, 18,52 mm, BS</i>	254930	254931
10.3	Windshield glass, 8.76 mm, laminated safety glass <i>Frontscheibe VSG, 8,76 mm, komplett</i>	209079	246107
11.1	Door window glass, 5 mm, single-pane safety glass <i>Türscheibe ESG, 5 mm, geklebt</i>	209020	246118
12.1	Side window glass, 5 mm, single-pane safety glass, left side <i>Seitenscheibe links, ESG, 5 mm, geklebt</i>	209019	246115
12.2	Side window glass, 8.76 mm, laminated safety glass, left side <i>Seitenscheibe links, VSG, 8,76 mm, geklebt</i>	209084	-
13	Rear window glass, 5 mm, single-pane safety glass <i>Heckscheibe ESG, 5 mm, geklebt</i>	209081	246111
14.1	Skylight, laminated safety glass <i>Dachscheibe VSG, 8,76 mm, geklebt</i>	209021	-
14.2	Skylight, bulletproof glass <i>Dachscheibe Panzerglas, 18,52 mm, geklebt</i>	254935	254936
15.1	Side window glass, 5 mm, single-pane safety glass, right side <i>Seitenscheibe rechts, ESG, 5 mm, geklebt</i>	209018	246112
15.2	Side window glass, 8.76 mm, laminated safety glass, right side <i>Seitenscheibe rechts, VSG, 8,76 mm, geklebt</i>	209085	-
20	Wiper system windshield <i>Wischanlage Frontscheibe unten</i>	255184	255185
21	Wiper system rear window <i>Wischanlage Heckscheibe</i>	255186	255187
22	Wiper system skylight <i>Wischanlage Dachscheibe</i>	255182	255183
30	Protective grid front, FOPS <i>Schutzgitter Front, FOPS</i>	209091	246089
31.1	Protective grid top, level 1 <i>Schutzgitter Dach, Level 1, klappbar</i>	255188	255189
31.2	Protective grid top, FOPS, level 2 + mesh grid <i>Schutzgitter Dach, FOPS, Level 2 komplett + Maschengitter</i>	255190	255191
60	Blind top <i>Sonnenrollo Dach</i>	209029	246126
61.1	Blind front <i>Sonnenrollo Front</i>	209099	246125
61.2	Sunvisor front <i>Sonnenblende Front</i>	107095	246124
	Multi-functional armrest for driver's seat (product Aguti Command) <i>Multi-Funktions-Armlehnen für Fahrersitz (Fabrikat Aguti Command)</i>	217568	217568
	Seat cover for SENNEBOGEN seat (only for seat 199475) <i>Schonbezug für SENNEBOGEN Sitze (nur für Sitz 199475)</i>	218120	218120
	Hand fire extinguisher, type PD6 (1 piece) <i>Handfeuerlöscher, Typ PD6 (1 Stück)</i>	231812	231812
	Radio (Bluetooth, SD, USB, AUX, MP3) <i>Radio (Bluetooth, SD, USB, AUX, MP3)</i>	260163	260163

1.3 CABINS: SPARE PARTS AND OPTIONS / KABINEN: ERSATZTEILE UND OPTIONEN

MaxCab 1

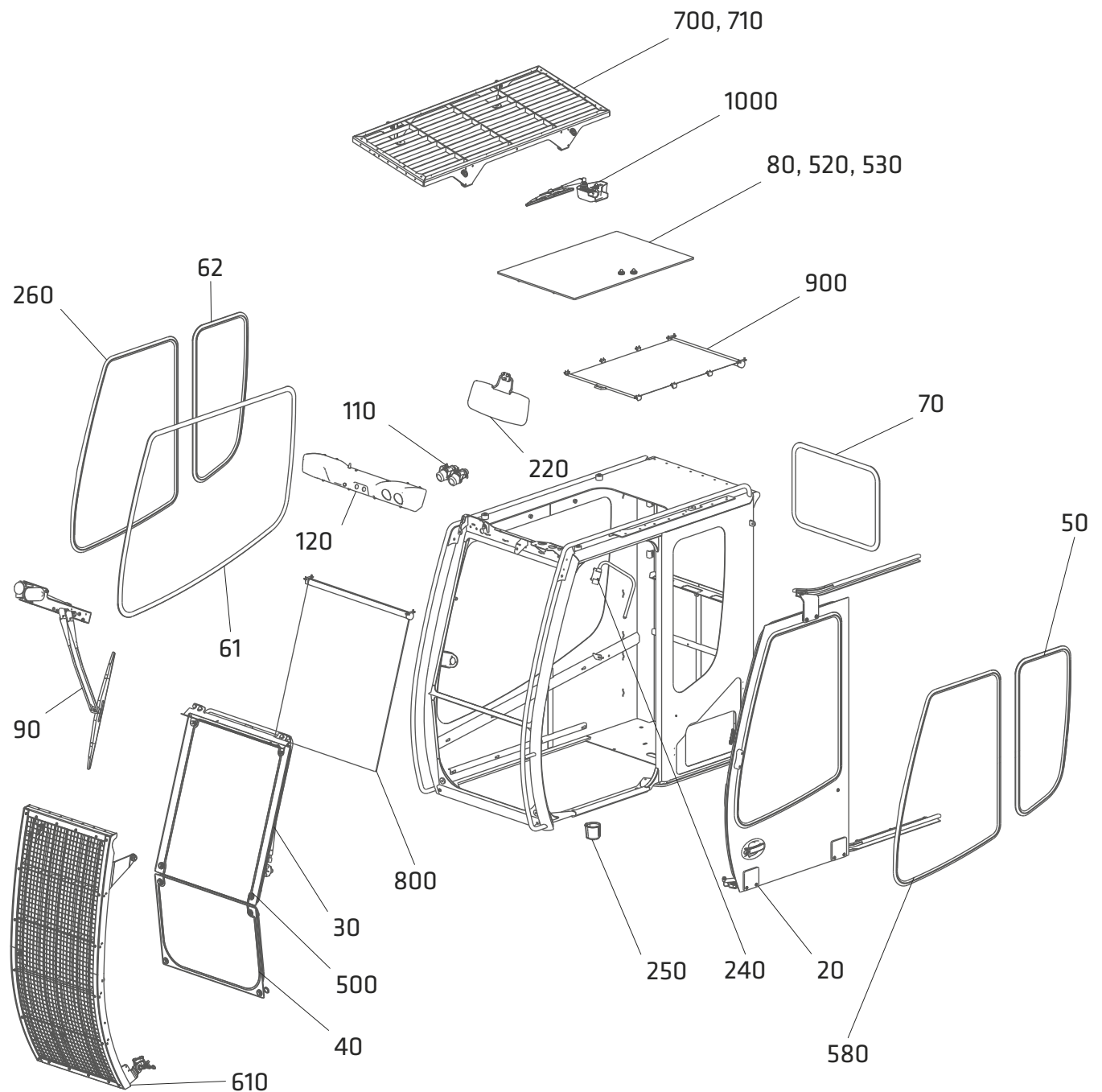

1.3 CABINS: SPARE PARTS AND OPTIONS / KABINEN: ERSATZTEILE UND OPTIONEN

	Description <i>Bezeichnung</i>	No. <i>Nr.</i>
20	Door – sliding door with side window <i>Tür – Schiebetür mit Seitenscheibe</i>	167837
580	Door window (sliding window) <i>Türscheibe (Schiebescheibe)</i>	151620
30	Upper windshield glass, single-pane safety glass <i>Frontscheibe oben, ESG</i>	107068
40	Lower windshield glass, single-pane safety glass <i>Frontscheibe unten, ESG</i>	107076
500	Retrofit kit windshield glass, bulletproof <i>Nachrüstsatz Frontscheibe komplett, Panzerglas</i>	118694
50	Side window glass, single-pane safety glass, left side <i>Seitenscheibe links, ESG</i>	166654
61	Side window glass right side (single piece), single-pane safety glass <i>Seitenscheibe rechts einteilig, ESG</i>	168547
260	Side window glass right side (two-piece, front), single-pane safety glass <i>Seitenscheibe rechts zweiteilig, vorne, ESG</i>	166521
62	Side window glass right side (two-piece, rear), single-pane safety glass <i>Seitenscheibe rechts zweiteilig, hinten, ESG</i>	166523
70	Rear window glass, single-pane safety glass <i>Heckscheibe, ESG</i>	166653
80	Skylight with sun protection <i>Dachscheibe mit Sonnenschutz</i>	108087
520	Skylight laminated safety glass <i>Dachscheibe VSG</i>	108084
530	Skylight bulletproof <i>Dachscheibe Panzerglas</i>	108077
90	Wiper system windshield <i>Wischeranlage Frontscheibe</i>	100492
1000	Wiper system skylight <i>Wischeranlage Dachscheibe</i>	265257
220.1	Sunvisor <i>Sonnenblende</i>	107094
220.2	Sunvisor for bulletproof glass <i>Sonnenblende für Panzerglas-Scheibe</i>	108418
240	Holder side mirror <i>Halter Außenspiegel</i>	104075
250	Bottle holder <i>Flaschenhalter</i>	155871
610	Protective grid front <i>Schutzgitter Front</i>	135395
700	Protective grid top, FOPS level 2 + mesh grid <i>Schutzgitter Dach, FOPS, Level 2 + Maschengitter</i>	255190
710	Protective grid top, FOPS level 1 <i>Schutzgitter Dach, FOPS, Level 1</i>	107229
800	Blind front <i>Rollo Frontscheibe</i>	156995
900	Blind top <i>Rollo Dachscheibe</i>	107096
110	Cabin headlight <i>Kabinenscheinwerfer</i>	110128
120	Cover <i>Abdeckung</i>	108190
	Multi-functional armrest for driver's seat (product Aguti Command) <i>Multi-Funktions-Armlehnen für Fahrersitz (Fabrikat Aguti Command)</i>	217568
	Loudspeaker system with microphone <i>Lautsprechersystem mit Mikrofon</i>	228222

1.3 CABINS: SPARE PARTS AND OPTIONS / KABINEN: ERSATZTEILE UND OPTIONEN

MaxCab 2 (Standard)

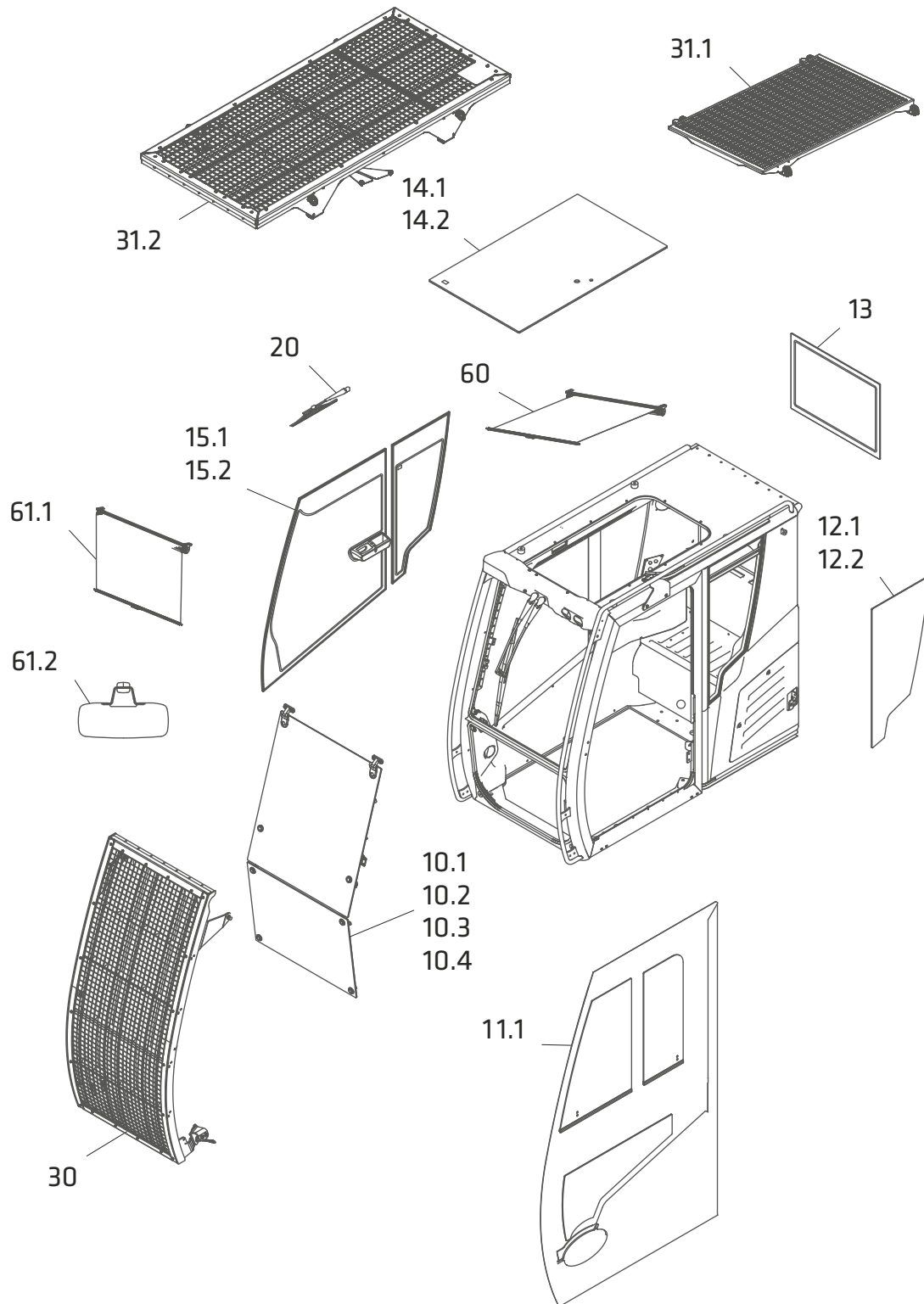

1.3 CABINS: SPARE PARTS AND OPTIONS / KABINEN: ERSATZTEILE UND OPTIONEN

	Description <i>Bezeichnung</i>	No. <i>Nr.</i>
10.1	Windshield glass, 6 mm, single-pane safety glass (hinged) <i>Frontscheibe ESG, 6 mm, komplett (klappbar)</i>	209113
10.2	Windshield glass, 8.76 mm, laminated safety glass (fastened) <i>Frontscheibe VSG, 8,76 mm, komplett (fest)</i>	209119
10.3	Windshield glass, 18.52 mm, bulletproof glass (fastened) <i>Frontscheibe Panzerglas, 18,52 mm, komplett (fest)</i>	209193
10.4	Windshield glass, 6 mm, single-pane safety glass (fastened) <i>Frontscheibe ESG, 6 mm, komplett (fest)</i>	209234
11.1	Door – sliding door with sliding window, single-pane safety glass <i>Tür – Schiebetür mit Schiebescheibe ESG, 5mm, komplett</i>	209275
12.1	Side window glass, 5 mm, single-pane safety glass, left side <i>Seitenscheibe links, ESG, 5 mm, geklebt</i>	209118
12.2	Side window glass, 8.76 mm, laminated safety glass, left side <i>Seitenscheibe links, VSG, 8,76 mm, geklebt</i>	209202
13	Rear window glass, 5 mm, single-pane safety glass <i>Heckscheibe ESG, 5 mm, geklebt</i>	209116
14.1	Skylight, laminated safety glass <i>Dachscheibe VSG, 8,76 mm, parsolgrün, geklebt</i>	209120
14.2	Skylight, bulletproof glass <i>Dachscheibe Panzerglas, 18,52 mm, geklebt</i>	209194
15.1	Side window glass, 5 mm, single-pane safety glass, right side <i>Seitenscheibe rechts, ESG, 5 mm, geklebt</i>	209218
15.2	Side window glass, 8.76 mm, laminated safety glass, right side <i>Seitenscheibe rechts, VSG, 8,76 mm, geklebt</i>	209219
20	Wiper system skylight <i>Wischanlage Dachscheibe, komplett</i>	265257
	Wiper system upper windshield <i>Wischanlage Frontscheibe oben</i>	100492
	Wiper system lower windshield <i>Wischanlage Frontscheibe unten</i>	257801
30	Protective grid front, FOPS <i>Schutzgitter Front, FOPS, komplett</i>	256782
31.1	Protective grid top, level 1 <i>Schutzgitter Dach, Level 1, klappbar</i>	107229
31.2	Protective grid top, FOPS, level 2 + mesh grid <i>Schutzgitter Dach, FOPS, Level 2 komplett + Maschengitter</i>	255190
60	Blind top <i>Rollo Dach</i>	209125
61.1	Blind front <i>Rollo Front</i>	209124
61.2	Sunvisor front <i>Sonnenblende Front</i>	107095
	Multi-functional armrest for driver's seat (product Aguti Command) <i>Multi-Funktions-Armelehnen für Fahrersitz (Fabrikat Aguti Command)</i>	217568
	Seat cover for SENNEBOGEN seat (only for seat 199475) <i>Schonbezug für SENNEBOGEN Sitze (nur für Sitz 199475)</i>	218120
	Hand fire extinguisher, type PD6 (1 piece) <i>Handfeuerlöscher, Typ PD6 (1 Stück)</i>	231812
	Radio (Bluetooth, SD, USB, AUX, MP3) <i>Radio (Bluetooth, SD, USB, AUX, MP3)</i>	260163
	Cooling Box behind operator's seat <i>Kühlbox hinter dem Fahrersitz</i>	260167
	Loudspeaker system with microphone <i>Lautsprechersystem mit Mikrofon</i>	228222

1.3 CABINS: SPARE PARTS AND OPTIONS / KABINEN: ERSATZTEILE UND OPTIONEN

MaxCab 2 (Industrial)

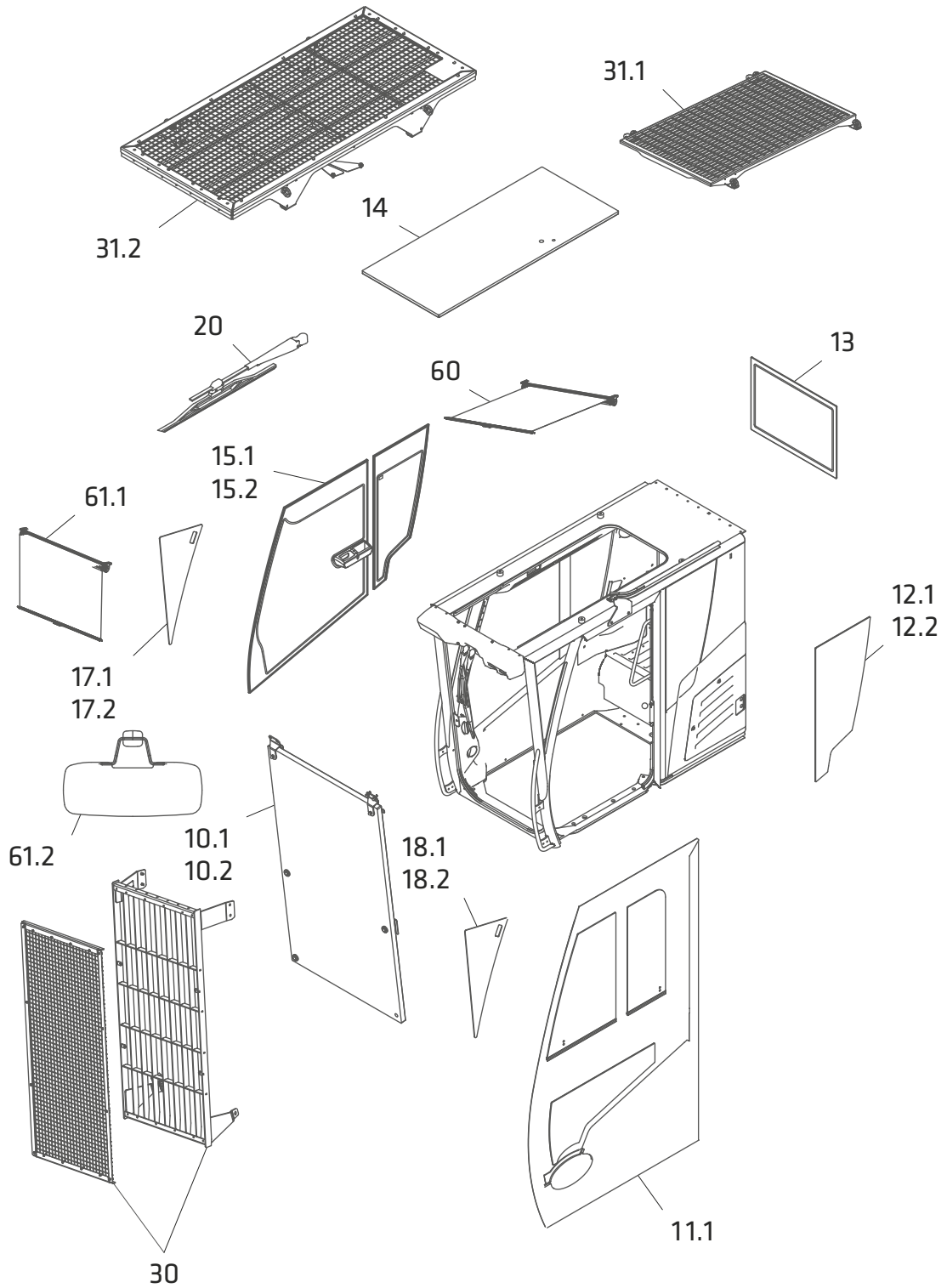

1.3 CABINS: SPARE PARTS AND OPTIONS / KABINEN: ERSATZTEILE UND OPTIONEN

	Description <i>Bezeichnung</i>	No. <i>Nr.</i>
10.1	Windshield glass, 30 mm, bulletproof glass <i>Frontscheibe Panzerglas, 30 mm</i>	209250
10.2	Windshield glass, 40 mm, bulletproof glass <i>Frontscheibe Panzerglas, 40 mm</i>	209253
11.1	Door – sliding door with sliding window, single-pane safety glass <i>Tür – Schiebetür, mit Schiebescheibe ESG, 5 mm</i>	209275
12.1	Side window glass, 5 mm, single-pane safety glass, left side <i>Seitenscheibe – links, ESG, 5 mm, geklebt</i>	209118
12.2	Side window glass, 8.76 mm, laminated safety glass, left side <i>Seitenscheibe – links, VSG, 8,76 mm, geklebt</i>	209202
13	Rear window glass, 5 mm, single-pane safety glass <i>Heckscheibe – ESG, 5 mm, geklebt</i>	209116
14	Skylight, 18.52 mm, bulletproof glass <i>Dachscheibe – Panzerglas, 18,52 mm, geklebt</i>	209242
15.1	Side window glass, 5 mm, single-pane safety glass, right side <i>Seitenscheibe – rechts, ESG, 5 mm, geklebt</i>	209218
15.2	Side window glass, 8.76 mm, laminated safety glass, right side <i>Seitenscheibe – rechts, VSG, 8,76 mm, geklebt</i>	209219
17.1	Side window glass, 5 mm, single-pane safety glass, right side (small) <i>Seitenscheibe – rechts ganz vorne, ESG, 5 mm, geklebt</i>	209258
17.2	Side window glass, 18.52 mm, bulletproof glass, right side (small) <i>Seitenscheibe – rechts ganz vorne, PZG, 18,52 mm, geklebt</i>	209260
18.1	Side window glass, 5 mm, single-pane safety glass, left side (small) <i>Seitenscheibe – links ganz vorne, ESG, 5 mm, geklebt</i>	209257
18.2	Side window glass, 18.52 mm, bulletproof glass, left side (small) <i>Seitenscheibe – links ganz vorne, PZG, 18,52 mm, geklebt</i>	209259
20	Wiper system skylight <i>Wischanlage Dachscheibe – MaxCab 2, 24 V, 0,5 Nm</i>	265257
	Wiper system upper windshield <i>Wischanlage Frontscheibe oben</i>	100492
	Wiper system lower windshield <i>Wischanlage Frontscheibe unten</i>	257801
30	Protective grid front, FOPS <i>Schutzgitter – Front, FOPS</i>	209246
31.1	Protective grid top, level 1 <i>Schutzgitter – Dach, Level 1, klappbar</i>	107229
31.2	Protective grid top, FOPS, level 2 + mesh grid <i>Schutzgitter – Dach, FOPS, Level 2 komplett + Maschengitter</i>	255190
60	Blind top <i>Rollo Dach – MaxCab 2, Industrieversion</i>	209254
61.1	Blind front <i>Rollo – Front</i>	209164
61.2	Sunvisor front <i>Sonnenblende – Front</i>	107095
	Multi-functional armrest for driver's seat (product Aguti Command) <i>Multi-Funktions-Armlehnen für Fahrersitz (Fabrikat Aguti Command)</i>	217568
	Seat cover for SENNEBOGEN seat (only for seat 199475) <i>Schonbezug für SENNEBOGEN Sitze (nur für Sitz 199475)</i>	218120
	Hand fire extinguisher, type PD6 (1 piece) <i>Handfeuerlöscher, Typ PD6 (1 Stück)</i>	231812
	Radio (Bluetooth, SD, USB, AUX, MP3) <i>Radio (Bluetooth, SD, USB, AUX, MP3)</i>	260163
	Cooling Box behind operator's seat <i>Kühlbox hinter dem Fahrersitz</i>	260167
	Loudspeaker system with microphone <i>Lautsprechersystem mit Mikrofon</i>	228222

1.4 CLIMATIC-COMFORT-SEATS KLIMA-KOMFORT-SITZE

Maximum Comfort needed for fatigue-free operation
Höchster Komfort für ermüdungsfreies Arbeiten

- **integrated seat climate control (ventilation/heating)**
- pneumatic lumbar support with memory function
- horizontal and vertical shock absorber
- adjustable cushion depth and seat inclination
- variably adjustable seat height and shock absorber
- *aktive Sitzklimatisierung (Lüften/Heizen)*
- *Entlastung des Rückens durch pneumatische Lendenwirbelstütze*
- *Horizontal- und Vertikalschwingungsdämpfung*
- *Sitzkissentiefe und Sitzneigung einstellbar*
- *Sitzhöhe und Federung stufenlos einstellbar*



Operator Highlight
Highlight am Fahrerplatz

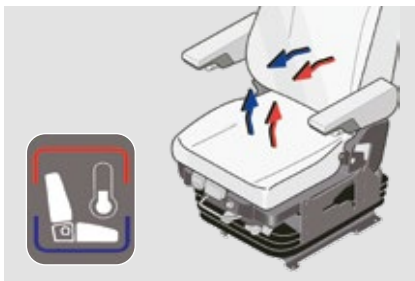









Series <i>Serie</i>	Mounted Standard Seat <i>Vorhandene Serienausstattung</i>	Order Number <i>Bestellnummer</i>
D-series / <i>D-Serie</i>	140368*	162378
E-series / <i>E-Serie</i>	168453*	162377
	199475*	199476

* Compare this number with your machine documentation / *Vergleichen Sie diese Nummer mit Ihrer Maschinendokumentation*







1.5 HYDRAULIC HYDRAULIK

Hydraulic Oil Filters / Hydraulikölfilter





	Description <i>Bezeichnung</i>	l (max) <i>L (max)</i>	Ø	No. <i>Nr.</i>
	return filter <i>Rücklauffilter</i>	145 mm	60 mm	014314
	return filter <i>Rücklauffilter</i>	428 mm	85 mm	027715
	return filter <i>Rücklauffilter</i>	465 mm	100 mm	009100
	return filter <i>Rücklauffilter</i>	632 mm	107 mm	150307
	return filter <i>Rücklauffilter</i>	768 mm	180 mm	151945
	ultra-fine filter <i>Feinstfilter</i>	280 mm	85 mm	046971
	HydroClean <i>HydroClean</i>	400 mm	85 mm	150309
	leakage oil filter <i>Leckölfilter</i>	115 mm	45 mm	024539

1.5 HYDRAULIC / HYDRAULIK

Hydraulic Oil Filters / Hydraulikölfilter

	Description <i>Bezeichnung</i>	l (max) <i>L (max)</i>	Ø	No. <i>Nr.</i>
	leakage oil filter <i>Leckölfilter</i>	310 mm	85 mm	063580
	leakage oil filter <i>Leckölfilter</i>	312 mm	87 mm	027376
	auxiliary control filter <i>Vorsteuerfilter</i>	90 mm	45 mm	034120
	auxiliary control filter <i>Vorsteuerfilter</i>	95 mm	35 mm	018439
	auxiliary control filter <i>Vorsteuerfilter</i>	102 mm	56 mm	150308
	pressure filter <i>Druckfilter</i>	110 mm	55 mm	140745
	pressure filter <i>Druckfilter</i>	152 mm	46 mm	205125
	pressure filter <i>Druckfilter</i>	155 mm	45 mm	154938

1.5 HYDRAULIC / HYDRAULIK

	Description <i>Bezeichnung</i>	l (max) <i>L (max)</i>	Ø	No. <i>Nr.</i>
	pressure filter <i>Druckfilter</i>	195 mm	45 mm	154936
	pressure filter <i>Druckfilter</i>	203 mm	73 mm	154933
	pressure filter <i>Druckfilter</i>	220 mm	80 mm	019780
	charge pressure filter <i>Speisedruckfilter</i>	85 mm	45 mm	154947

Ventilation Filters / *BelüftungsfILTER*





Ventilation Filter <i>BelüftungsfILTER</i>	No. <i>Nr.</i>	Filter Element <i>Filterelement</i>	No. <i>Nr.</i>	Opening Pressure <i>Öffnungsdruck</i>	Filter Sieve <i>Filtersieb</i>	No. <i>Nr.</i>
	014647		014721	0,03 bar (in) 0,35 bar (out)		
	100040		174541	0,03 bar (in) 0,35 bar (out)		014723
	170079		153955	0,03 bar (in) 0,85 bar (out)		
	058865		057228	n. s.		064213

1.6 ENGINE MOTOR











Crankcase Ventilations / Kurbelgehäuseentlüftungen

	Description <i>Bezeichnung</i>	Engine <i>Motor</i>	No. <i>Nr.</i>
	crankcase ventilation <i>Kurbelgehäuseentlüftung</i>	QSB 4.5 - C130	169954
	crankcase ventilation <i>Kurbelgehäuseentlüftung</i>	QSB 6.7 - C220	169482
	crankcase ventilation <i>Kurbelgehäuseentlüftung</i>	QSL 9 - C300	169483
	crankcase ventilation <i>Kurbelgehäuseentlüftung</i>	QSX 15 - C525	189223
	crankcase ventilation <i>Kurbelgehäuseentlüftung</i>	FPT NEF 45	206075

Engine Oil Filters / MotorölfILTER

	Description <i>Bezeichnung</i>	Usage <i>Verwendung</i>	l (max) <i>L (max)</i>	Ø	No. <i>Nr.</i>
	engine oil filter <i>MotorölfILTER</i>	Cummins	180 mm	98 mm	106924
	engine oil filter <i>MotorölfILTER</i>	Cummins	245 mm	120 mm	205575
	engine oil filter <i>MotorölfILTER</i>	Cummins	295 mm	120 mm	147098
	engine oil filter <i>MotorölfILTER</i>	Cummins	300 mm	118 mm	157835









1.6 ENGINE / MOTOR

	Description <i>Bezeichnung</i>	Usage <i>Verwendung</i>	l (max) <i>L (max)</i>	Ø	No. <i>Nr.</i>
	engine oil filter <i>Motorölfilter</i>	Cummins	300 mm	120 mm	189624
	engine oil filter <i>Motorölfilter</i>	Cummins	360 mm	118 mm	135261
	engine oil filter <i>Motorölfilter</i>	Deutz	140 mm	95 mm	027025
	engine oil filter <i>Motorölfilter</i>	Deutz	152 mm	80 mm	080543
	engine oil filter <i>Motorölfilter</i>	Deutz	205 mm	94 mm	027026
	engine oil filter <i>Motorölfilter</i>	Deutz	265 mm	110 mm	038923
	engine oil filter <i>Motorölfilter</i>	CAT	200 mm	92 mm	177580
	engine oil filter <i>Motorölfilter</i>	CAT	230 mm	136 mm	142980
	engine oil filter <i>Motorölfilter</i>	CAT	265 mm	110 mm	080749
	engine oil filter <i>Motorölfilter</i>	CAT	305 mm	135 mm	085693
	engine oil filter <i>Motorölfilter</i>	FPT	175 mm	95 mm	206076





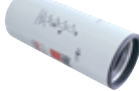







1.7 FUEL SYSTEM

KRAFTSTOFFSYSTEM

Fuel Filters / Kraftstofffilter















	Description <i>Bezeichnung</i>	Usage <i>Verwendung</i>	l (max) <i>L (max)</i>	Ø	No. <i>Nr.</i>
	fuel filter <i>Kraftstofffilter</i>	Cummins	175 mm	92 mm	189578
	fuel filter <i>Kraftstofffilter</i>	Cummins	175 mm	94 mm	158318
	fuel filter <i>Kraftstofffilter</i>	Cummins	175 mm	95 mm	125541
	fuel filter <i>Kraftstofffilter</i>	Cummins	180 mm	110 mm	169951
	fuel filter <i>Kraftstofffilter</i>	Cummins FPT	190 mm	94 mm	103142
	fuel filter <i>Kraftstofffilter</i>	Cummins	200 mm	92 mm	167975
	fuel filter <i>Kraftstofffilter</i>	Cummins	230 mm	124 mm	189623
	fuel filter <i>Kraftstofffilter</i>	Cummins	254 mm	96 mm	136897
	fuel filter <i>Kraftstofffilter</i>	Cummins	300 mm	120 mm	241361
	fuel filter <i>Kraftstofffilter</i>	Deutz	100 mm	75 mm	080544
	fuel filter <i>Kraftstofffilter</i>	Deutz	110 mm	80 mm	030483
	fuel filter <i>Kraftstofffilter</i>	Deutz	120 mm	75 mm	038268

1.7 FUEL SYSTEM / KRAFTSTOFFSYSTEM

	Description <i>Bezeichnung</i>	Usage <i>Verwendung</i>	l (max) <i>L (max)</i>	Ø	No. <i>Nr.</i>
	fuel filter <i>Kraftstofffilter</i>	Deutz	140 mm	95 mm	106184
	fuel filter <i>Kraftstofffilter</i>	Deutz	140 mm	95 mm	089014
	fuel filter <i>Kraftstofffilter</i>	Deutz	140 mm	95 mm	038922
	fuel filter <i>Kraftstofffilter</i>	CAT	150 mm	80 mm	219995
	fuel filter <i>Kraftstofffilter</i>	CAT	200 mm	85 mm	177606
	fuel filter <i>Kraftstofffilter</i>	CAT	310 mm	134 mm	224592
	fuel filter <i>Kraftstofffilter</i>	FPT	190 mm	100 mm	206184
	fuel filter <i>Kraftstofffilter</i>	Deutz	185 mm	82 mm	106109
	fuel filter <i>Kraftstofffilter</i>	Deutz	215 mm	98 mm	084776
	fuel filter <i>Kraftstofffilter</i>	CAT	180 mm	85 mm	043277
	fuel filter <i>Kraftstofffilter</i>	CAT	180 mm	90 mm	040736
	fuel filter <i>Kraftstofffilter</i>	CAT	240 mm	95 mm	040247
	fuel filter <i>Kraftstofffilter</i>	CAT	270 mm	95 mm	105680

1.7 FUEL SYSTEM / KRAFTSTOFFSYSTEM

Water Separators / Wasserabscheider

	Description <i>Bezeichnung</i>	Usage <i>Verwendung</i>	l (max) <i>L (max)</i>	Ø	No. <i>Nr.</i>
	water separator <i>Wasserabscheider</i>	Cummins	180 mm	95 mm	155512
	water seperator, heatable <i>Wasserabscheider, beheizbar</i>	Cummins	180 mm	95 mm	109674
	water seperator, heatable <i>Wasserabscheider, beheizbar</i>	Cummins	180 mm	105 mm	165338
	water separator <i>Wasserabscheider</i>	Cummins	205 mm	95 mm	103139
	water separator <i>Wasserabscheider</i>	Cummins	240 mm	95 mm	176434
	water separator <i>Wasserabscheider</i>	Cummins	250 mm	95 mm	158317
	water separator <i>Wasserabscheider</i>	Cummins	295 mm	118 mm	135264
	water separator <i>Wasserabscheider</i>	Cummins	315 mm	120 mm	147101
	water separator <i>Wasserabscheider</i>	CAT	220 mm	110 mm	064893
	water separator <i>Wasserabscheider</i>	CAT	225 mm	80 mm	171162
	water separator <i>Wasserabscheider</i>	CAT	240 mm	110 mm	083176
	water separator <i>Wasserabscheider</i>	CAT	270 mm	106 mm	224599
	water separator <i>Wasserabscheider</i>	Deutz	158 mm	109 mm	096151
	water separator <i>Wasserabscheider</i>	Deutz	190 mm	110 mm	147645



1.7 FUEL SYSTEM / KRAFTSTOFFSYSTEM

	Description Bezeichnung	Usage Verwendung	l (max) L (max)	Ø	No. Nr.
	water separator Wasserabscheider	Deutz	220 mm	110 mm	115149
	water separator Wasserabscheider	Deutz	270 mm	110 mm	148781
	water separator Wasserabscheider	Deutz	75 x 75 mm	55 mm	087039
	water separator Wasserabscheider	Deutz	90 x 90 mm	55 mm	087040
	water separator Wasserabscheider	Deutz	90 x 90 mm	55 mm	071796
	water separator Wasserabscheider	Deutz	140 x 140 mm	55 mm	037036

Filling Sieves / Einfüllsiebe

	Description Bezeichnung	Usage Verwendung	l (max) L (max)	Ø	No. Nr.
	filling sieve Einfüllsieb	fuel tank Kraftstofftank	250 mm	80 mm	150958



Vent Filters / EntlüftungsfILTER

	Description Bezeichnung	Usage Verwendung	Mounting thread Einschraubgewinde	No. Nr.
	vent filter EntlüftungsfILTER	fuel tank Kraftstofftank	M14 x 1,5	127987
	vent filter EntlüftungsfILTER	fuel tank Kraftstofftank	M16 x 1,5	151010
	vent filter EntlüftungsfILTER	fuel tank Kraftstofftank	M22 x 1,5	168306

1.8 COOLING SYSTEM

KÜHLSYSTEM

Coolant Filters / Kühlwasserfilter





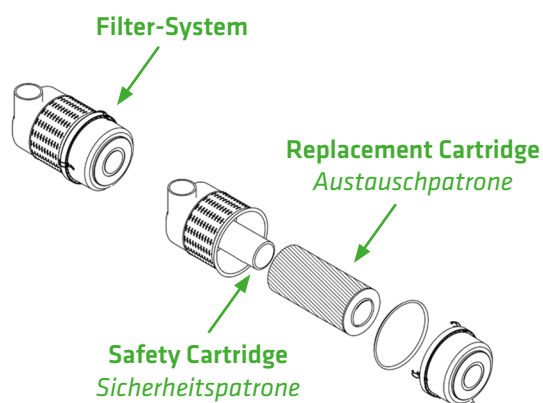











	Description <i>Bezeichnung</i>	Usage <i>Verwendung</i>	l (max) <i>L (max)</i>	Ø	No. <i>Nr.</i>
	coolant filter <i>Kühlwasserfilter</i>	Cummins	138 mm	95 mm	158319
	coolant filter <i>Kühlwasserfilter</i>	Cummins	140 mm	96 mm	136896
	coolant filter <i>Kühlwasserfilter</i>	Cummins	148 mm	95 mm	135265

1.9 AIR FILTERS LUFTFILTER



Filter-System	Filter Element Filterelement		Dimensions Abmessungen	No. Nr.
015576	replacement cartridge Austauschpatrone		350 mm x 165 mm	008261
	safety cartridge Sicherheitspatrone		345 mm x 80 mm	015568
047382	replacement cartridge Austauschpatrone		370 mm x 160 mm	047387
	safety cartridge Sicherheitspatrone		360 mm x 85 mm	047386
028694, 011073	replacement cartridge Austauschpatrone		375 mm x 200 mm	011076
028694	safety cartridge Sicherheitspatrone		375 mm x 100 mm	028693
056532, 102115	replacement cartridge Austauschpatrone		400 mm x 198 mm	072386
	safety cartridge Sicherheitspatrone		385 mm x 103 mm	072385
096991	replacement cartridge Austauschpatrone		400 mm x 220 mm	100720
	safety cartridge Sicherheitspatrone		385 mm x 115 mm	100719

1.9 AIR FILTERS / LUFTFILTER

Filter-System	Filter Element <i>Filterelement</i>		Dimensions <i>Abmessungen</i>	No. <i>Nr.</i>
019822	replacement cartridge <i>Austauschpatrone</i>		495 mm x 240 mm	019823
	safety cartridge <i>Sicherheitspatrone</i>		480 mm x 145 mm	019824
056533, 119892	replacement cartridge <i>Austauschpatrone</i>		540 mm x 240 mm	118606
	safety cartridge <i>Sicherheitspatrone</i>		525 mm x 135 mm	064200
056553, 147862	replacement cartridge <i>Austauschpatrone</i>		594 mm x 298 mm	068826
	safety cartridge <i>Sicherheitspatrone</i>		573 mm x 198 mm	068827
050098	replacement cartridge <i>Austauschpatrone</i>		620 mm x 330 mm	050099
	safety cartridge <i>Sicherheitspatrone</i>		610 mm x 215 mm	050100
162439	replacement cartridge <i>Austauschpatrone</i>		235 mm x 190 mm x 360 mm	169952
	safety cartridge <i>Sicherheitspatrone</i>		225 mm x 175 mm x 40 mm	169953
155134	replacement cartridge <i>Austauschpatrone</i>		300 mm x 280 mm x 360 mm	157840
	safety cartridge <i>Sicherheitspatrone</i>		285 mm x 265 mm x 40 mm	157839
201736	replacement cartridge <i>Austauschpatrone</i>		390 mm x 190 mm x 425 mm	205230
	safety cartridge <i>Sicherheitspatrone</i>		380 mm x 144 mm x 50 mm	205231
190797	replacement cartridge <i>Austauschpatrone</i>		405 mm x 150 mm x 260 mm	187692
	safety cartridge <i>Sicherheitspatrone</i>		394 mm x 138 mm x 40 mm	167974

1.9 AIR FILTERS / LUFTFILTER



Filter-System	Filter Element Filterelement		Dimensions Abmessungen	No. Nr.
165031, 166628	replacement cartridge <i>Austauschpatrone</i>		405 mm x 150 mm x 360 mm	167973
	safety cartridge <i>Sicherheitspatrone</i>		394 mm x 138 mm x 40 mm	167974
147315	replacement cartridge <i>Austauschpatrone</i>		345 mm x 210 mm x 290 mm	149256
	safety cartridge <i>Sicherheitspatrone</i>		335 mm x 190 mm x 40 mm	149255
138675, 147936, 149724	replacement cartridge <i>Austauschpatrone</i>		400 mm x 260 mm x 340 mm	146690
	safety cartridge <i>Sicherheitspatrone</i>		385 mm x 245 mm x 40 mm	146689
177940, 177941	replacement cartridge <i>Austauschpatrone</i>		460 mm x 260 mm x 335 mm	177943
	safety cartridge <i>Sicherheitspatrone</i>		430 mm x 235 mm x 40 mm	177942

Pre-Separator / Vorabscheider

Filter-System	Filter Element Filterelement		Dimensions Abmessungen	No. Nr.
DYNA Air DA 006 (108607)	filter sieve <i>Filtersieb</i>		200 mm x 300 mm	108828

1.10 ADBLUE FILTERS

ADBLUE-FILTER

	Description <i>Bezeichnung</i>	Usage <i>Verwendung</i>	Model Emission Standard	No. <i>Nr.</i>
	filter element <i>Filterelement</i>	AdBlue module filter <i>AdBlue Modulfilter</i>	818E, 821E, 825E, 830E, 835E, 840E, 850E, 730E, 735E,	181865
	filter element <i>Filterelement</i>	AdBlue tank filter <i>AdBlue Tankfilter</i>	613E, 673E, 6113E Tier 4f / IV	185149

1.11 HEATER / AC SYSTEM

HEIZUNG / KLIMAANLAGE

Filter Elements / *Filterelemente*

	Description <i>Bezeichnung</i>	Usage <i>Verwendung</i>	l (max) <i>L (max)</i>	w (max) <i>B (max)</i>	No. <i>Nr.</i>
	filter element <i>Filterelement</i>	MaxCab, inside <i>MaxCab, Innenluft</i>	246 mm	135 mm	107202
	filter element <i>Filterelement</i>	MaxCab, inside <i>MaxCab, Innenluft</i>	246 mm	135 mm	245656
	filter element, charcoal <i>Filterelement, Aktivkohle</i>	MaxCab, inside <i>MaxCab, Innenluft</i>	246 mm	135 mm	114628
	filter element <i>Filterelement</i>	MaxCab, outside <i>MaxCab, Außenluft</i>	398 mm	205 mm	107060
	filter element <i>Filterelement</i>	MaxCab, outside <i>MaxCab, Außenluft</i>	398 mm	205 mm	245666
	filter element, charcoal <i>Filterelement, Aktivkohle</i>	MaxCab, outside <i>MaxCab, Außenluft</i>	398 mm	205 mm	114627
	filter element <i>Filterelement</i>	MultiCab, AC system <i>MultiCab, Klimaanlage</i>	360 mm	170 mm	138361
	filter element, charcoal <i>Filterelement, Aktivkohle</i>	MultiCab, AC system <i>MultiCab, Klimaanlage</i>	360 mm	170 mm	145805
	filter element <i>Filterelement</i>	F2002, evaporator <i>F2002, Verdampferinheit</i>	484 mm	164 mm	099300
	filter element <i>Filterelement</i>	F2002, AC system <i>F2002, Klimaanlage</i>	346 mm	198 mm	037257
	filter element <i>Filterelement</i>	Port Cab, heating chamber <i>Port Cab, Heizschrank</i>	345 mm	195 mm	145317

1.11 HEATER / AC SYSTEM / HEIZUNG / KLIMAAANLAGE

Service-Set / Service-Set



Description Bezeichnung

This handy service-set includes small parts and seals frequently required for service work on air conditioning systems.

*Dieses handliche Service-Set beinhaltet häufig benötigte Klein-
teile und Dichtungen für Service-Arbeiten an Klimaanlage.*

Content / Inhalt

1 x Relay for magnetic coupling / Relais für Magnetkupplung

1 x Temperature sensor / Temperatursensor

1 x Pressure switch / Druckschalter









1 x Draining hose / Entwässerungsschlauch

4 x 10 O-rings / O-Ringe

No. Nr.

189726

Service Parts / Service-Teile

	Description Bezeichnung	Usage Verwendung	Dimensions Abmessungen	No. Nr.
	pressure switch Druckschalter	collector drier Sammlerrockner		064800
	relay Relais	magnetic coupling Magnetkupplung		109519
	temperature sensor Temperaturgeber			150261
	draining hose Entwässerungsschlauch		l = 345 mm	260596
	O-ring O-Ring	AC-hose Kältemittelschlauch	7,65 mm x 1,78 mm	099310
	O-ring O-Ring	AC-hose Kältemittelschlauch	10,82 mm x 1,78 mm	099308
	O-ring O-Ring	AC-hose Kältemittelschlauch	14 mm x 1,78 mm	099307
	O-ring O-Ring	AC-hose Kältemittelschlauch	17,17 mm x 1,78 mm	099309

*) Actual change interval depends on the results of the hydraulic oil analyses and the maintenance plan of the machine.

*) Tatsächliches Wechselintervall ist abhängig von den Ergebnissen der Hydraulikölanalysen und vom Wartungsplan der Maschine.

***) Ambient temperature **) Umgebungstemperatur

1.12 V-BELTS

KEILRIEMEN



Original SENNEBOGEN V-belts keep the aggregates on your machines running. Change intervals are noted in the inspection plan of your machine.

Original SENNEBOGEN Keilriemen halten die Aggregate Ihrer Maschinen stets am Laufen. Wechselintervalle sind im Inspektionsplan Ihrer Maschine notiert.

V-Belts / Keilriemen



Description <i>Bezeichnung</i>	Usage <i>Verwendung</i>	Specification <i>Spezifikation</i>	Type <i>Typ</i>	No. <i>Nr.</i>
V-belt <i>Keilriemen</i>	alternator <i>Lichtmaschine</i>	10 x 785	AVX	056632
V-belt <i>Keilriemen</i>	water pump <i>Wasserpumpe</i>	10 x 838	AVX	113641
V-belt <i>Keilriemen</i>	alternator <i>Lichtmaschine</i>	10 x 850	AVX	080011
V-belt <i>Keilriemen</i>	alternator <i>Lichtmaschine</i>	10 x 950	AVX	057405
V-belt <i>Keilriemen</i>	alternator <i>Lichtmaschine</i>	10 x 1000	AVX	040203
V-belt <i>Keilriemen</i>	water pump <i>Wasserpumpe</i>	10 x 1050	AVX	046687
V-belt <i>Keilriemen</i>	water pump <i>Wasserpumpe</i>	10 x 1200	AVX	080188
V-belt <i>Keilriemen</i>	water pump <i>Wasserpumpe</i>	10 x 1230	AVX	049081
V-belt <i>Keilriemen</i>	alternator <i>Lichtmaschine</i>	11 x 785	AVX	083957
V-belt <i>Keilriemen</i>	alternator <i>Lichtmaschine</i>	11 x 875	AVX	082454
V-belt <i>Keilriemen</i>	air conditioning system <i>Klimaanlage</i>	13 x 950	AVX	206782
V-belt <i>Keilriemen</i>	fan <i>Lüfter</i>	13 x 975	AVX	056633
V-belt <i>Keilriemen</i>	water pump <i>Wasserpumpe</i>	13 x 1000	AVX	080542

1.12 V-BELTS / KEILRIEMEN

Description <i>Bezeichnung</i>	Usage <i>Verwendung</i>	Specification <i>Spezifikation</i>	Type <i>Typ</i>	No. <i>Nr.</i>
V-belt <i>Keilriemen</i>	water pump <i>Wasserpumpe</i>	13 x 1016	AVX	093633
V-belt <i>Keilriemen</i>	water pump <i>Wasserpumpe</i>	13 x 1050	AVX	030288
V-belt <i>Keilriemen</i>	water pump <i>Wasserpumpe</i>	13 x 1050	AVX	109242
V-belt <i>Keilriemen</i>	air conditioning system <i>Klimaanlage</i>	13 x 1075	AVX	081733
V-belt <i>Keilriemen</i>	air conditioning system <i>Klimaanlage</i>	13 x 1125	AVX	049357
V-belt <i>Keilriemen</i>	air conditioning system <i>Klimaanlage</i>	13 x 1150	AVX	053292
V-belt <i>Keilriemen</i>	air conditioning system <i>Klimaanlage</i>	13 x 1175	AVX	059076
V-belt <i>Keilriemen</i>	air conditioning system <i>Klimaanlage</i>	13 x 1185	AVX	161492
V-belt <i>Keilriemen</i>	air conditioning system <i>Klimaanlage</i>	13 x 1200	AVX	059077
V-belt <i>Keilriemen</i>	air conditioning system <i>Klimaanlage</i>	13 x 1225	AVX	032090
V-belt <i>Keilriemen</i>	air conditioning system <i>Klimaanlage</i>	13 x 1235	AVX	103904
V-belt <i>Keilriemen</i>	air conditioning system <i>Klimaanlage</i>	13 x 1275	AVX	084264
V-belt <i>Keilriemen</i>	water pump <i>Wasserpumpe</i>	13 x 1350	AVX	097739
V-belt <i>Keilriemen</i>	air conditioning system <i>Klimaanlage</i>	13 x 1450	AVX	049981
V-belt <i>Keilriemen</i>	air conditioning system <i>Klimaanlage</i>	13 x 1600	AVX	139168
V-belt <i>Keilriemen</i>	air conditioning system <i>Klimaanlage</i>	13 x 1925	AVX	125540
V-belt <i>Keilriemen</i>	air conditioning system <i>Klimaanlage</i>	13 x 1950	AVX	105682
V-belt <i>Keilriemen</i>	fan <i>Lüfter</i>	WRZ 42 - 9086	AVX	147100
V-belt <i>Keilriemen</i>	air conditioning compressor <i>Klimakompressor</i>	13 x 950 FPT NEF 45	AV	239043

1.12 V-BELTS / KEILRIEMEN

V-Ribbed Belts / Keilrippenriemen



Description Bezeichnung	Usage Verwendung	Specification Spezifikation	Type Typ	No. Nr.
V-ribbed belt Keilrippenriemen	alternator Lichtmaschine	8 - PK 1473	PK	206172
V-ribbed belt Keilrippenriemen	water pump Wasserpumpe	10 - PK 1355	PK	108048
V-ribbed belt Keilrippenriemen	air conditioning system Klimaanlage	WRZ 20 - 2365	PK	106925
V-ribbed belt Keilrippenriemen	air conditioning system Klimaanlage	WRZ 20 - 2417	PK	116125
V-ribbed belt Keilrippenriemen	alternator Lichtmaschine	WRZ 20 - 3152	PK	189579
V-ribbed belt Keilrippenriemen	air conditioning system Klimaanlage	WRZ 20 - 3168	PK	172327
V-ribbed belt Keilrippenriemen	fan Lüfter	WRZ 20 - 9882	PK	158322
V-ribbed belt Keilrippenriemen	fan Lüfter	WRZ 21 - 0131	PK	167976
V-ribbed belt Keilrippenriemen	air conditioning system Klimaanlage	WRZ 21 - 1975	PK	132596
V-ribbed belt Keilrippenriemen	alternator Lichtmaschine	WRZ 21 - 1980	PK	135268
V-ribbed belt Keilrippenriemen	alternator Lichtmaschine	WRZ 21 - 2030	PK	132595
V-ribbed belt Keilrippenriemen	fan Lüfter	WRZ 21 - 2073	PK	135267
V-ribbed belt Keilrippenriemen	alternator Lichtmaschine	WRZ 21 - 2299	PK	170212

Narrow V-Belts / Schmalkeilriemen



Description Bezeichnung	Usage Verwendung	Specification Spezifikation	Type Typ	No. Nr.
narrow V-belt Schmalkeilriemen	water pump Wasserpumpe	12,7 x 864	XPA	080131
narrow V-belt Schmalkeilriemen	water pump Wasserpumpe	12,7 x 902	XPA	077160
narrow V-belt Schmalkeilriemen	water pump Wasserpumpe	12,7 x 1003	XPA	099128
narrow V-belt Schmalkeilriemen	air conditioning system Klimaanlage	12,7 x 1245	SPA	119236

1.12 V-BELTS / KEILRIEMEN

Description <i>Bezeichnung</i>	Usage <i>Verwendung</i>	Specification <i>Spezifikation</i>	Type <i>Typ</i>	No. <i>Nr.</i>
narrow V-belt <i>Schmalkeilriemen</i>	air conditioning system <i>Klimaanlage</i>	12,7 x 1257	SPA	066478
narrow V-belt <i>Schmalkeilriemen</i>	engine <i>Motor</i>	16,3 x 1460	XPB	075531
narrow V-belt <i>Schmalkeilriemen</i>	engine <i>Motor</i>	16,3 x 1900	XPB	081750
narrow V-belt <i>Schmalkeilriemen</i>	alternator <i>Lichtmaschine</i>	22 x 1448	XPC	072533
narrow V-belt <i>Schmalkeilriemen</i>	alternator <i>Lichtmaschine</i>	22 x 1486	XPC	093632

Power Belts / Kraftbänder



Description <i>Bezeichnung</i>	Usage <i>Verwendung</i>	Specification <i>Spezifikation</i>	Type <i>Typ</i>	No. <i>Nr.</i>
power belt <i>Kraftband</i>	generator <i>Generator</i>	2 SPB 2300	-	121041
power belt <i>Kraftband</i>	generator <i>Generator</i>	2 SPB 2360	-	080606
power belt <i>Kraftband</i>	generator <i>Generator</i>	2 SPB 2500	-	072950
power belt <i>Kraftband</i>	generator <i>Generator</i>	3 SPB 2650	-	072519
power belt <i>Kraftband</i>	generator <i>Generator</i>	3 SPB 2800	-	079826
power belt <i>Kraftband</i>	generator <i>Generator</i>	2 XPB 2300	-	135679
power belt <i>Kraftband</i>	generator <i>Generator</i>	2 XPB 2500	-	135294
power belt <i>Kraftband</i>	generator <i>Generator</i>	3 XPB 2650	-	135295
power belt <i>Kraftband</i>	generator <i>Generator</i>	3 XPB 2800	-	087776
power belt <i>Kraftband</i>	generator <i>Generator</i>	3 XPB 2840	-	136084
power belt <i>Kraftband</i>	generator <i>Generator</i>	3 XPB 2900	-	145526
power belt <i>Kraftband</i>	generator <i>Generator</i>	3-XPB 3150	-	085947

1.13 GAS SPRINGS

GASFEDERN

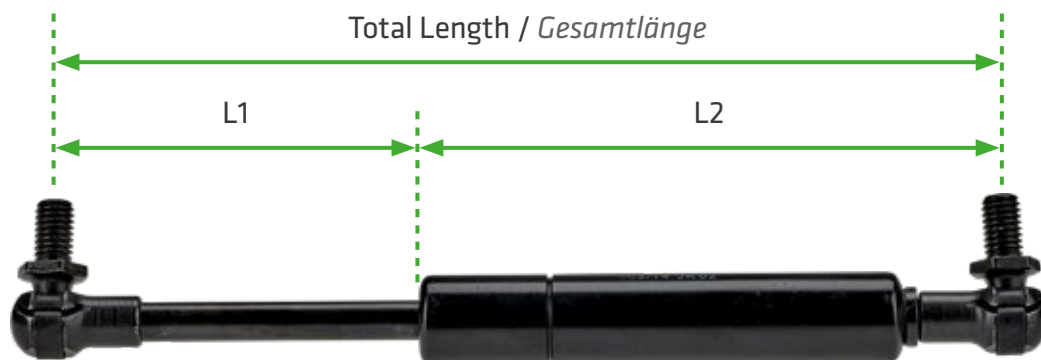

Original SENNEBOGEN gas springs offer highest power density in opening and holding devices.

Explanation of the given dimensions:

- Total Length = length of the gas spring from connection to connection with extended cylinder piston
- L1 = length of the cylinder piston from the connection to the start of the cylinder
- L2 = length of the cylinder from the start to the connection

Original SENNEBOGEN Gasfedern bieten höchste Leistungsdichte in Öffnungs- und Haltevorrichtungen.

Erklärung der angegebenen Maße:

- Gesamtlänge = Länge der Gasfeder von Anschluss zu Anschluss bei ausgefahrenem Zylinderkolben
- L1 = Länge des Zylinderkolbens von Anschluss zu Zylinderkante
- L2 = Länge des Zylinders von Zylinderkante zu Anschluss

Gas Springs (WG-WG)

Gasfedern (WG-WG)



Total Length Gesamtlänge	L1 L1	L2 L2	Compressive Force Druckkraft	Type Typ	No. Nr.
190 mm	75	115	500 N	WG-WG	097319
195 mm	85	110	250 N	WG-WG	050513
280 mm	120	160	300 N	WG-WG	108265
290 mm	115	175	150 N	WG-WG	051612
480 mm	205	275	230 N	WG-WG	107075*
505 mm	225	280	220 N	WG-WG	153511
525 mm	240	285	1000 N	WG-WG	163483

1.13 GAS SPRINGS / GASFEDERN

Gas Springs (A-A) Gasfedern (A-A)



Total Length <i>Gesamtlänge</i>	L1 <i>L1</i>	L2 <i>L2</i>	Compressive Force <i>Druckkraft</i>	Type <i>Typ</i>	No. <i>Nr.</i>
265 mm	125	140	200 N	A-A	029562
325 mm	150	175	600 N	A-A	044650
365 mm	170	195	150 N	A-A	048126
525 mm	245	280	500 N	A-A	085221
525 mm	245	280	600 N	A-A	068703
525 mm	245	280	700 N	A-A	068704
525 mm	245	280	800 N	A-A	085222
600 mm	285	315	150 N	A-A	121225
600 mm	285	315	250 N	A-A	010325
600 mm	285	315	450 N	A-A	014219
600 mm	285	315	550 N	A-A	019896
600 mm	285	315	650 N	A-A	032236
685 mm	325	360	600 N	A-A	098640
685 mm	325	360	1000 N	A-A	088262
685 mm	325	360	1150 N	A-A	088261
740 mm	350	390	800 N	A-A	121314
785 mm	375	410	250 N	A-A	049809
785 mm	375	410	500 N	A-A	042511
785 mm	375	410	600 N	A-A	042512
785 mm	375	410	800 N	A-A	043905
785 mm	375	410	1000 N	A-A	042792
785 mm	375	410	1150 N	A-A	042793

1.13 GAS SPRINGS / GASFEDERN

Gas Springs (G-G)
Gasfedern (G-G)

Total Length Gesamtlänge	L1	L2	Compressive Force Druckkraft	Type Typ	No. Nr.
668 mm	360	308	150 N	G-G	216883
821 mm	386	435	900 N	G-G	194072

Gas Springs (WG-G)
Gasfedern (WG-G)

Total Length Gesamtlänge	L1	L2	Compressive Force Druckkraft	Type Typ	No. Nr.
712 mm	330	382	500 N	WG-G	158346
712 mm	330	382	600 N	WG-G	158347
712 mm	330	382	700 N	WG-G	158348
712 mm	330	382	800 N	WG-G	159855
712 mm	330	382	1000 N	WG-G	237458
814 mm	380	434	600 N	WG-G	158350
814 mm	380	434	700 N	WG-G	158351
814 mm	380	434	800 N	WG-G	159856
814 mm	380	434	900 N	WG-G	172229
814 mm	380	434	1000 N	WG-G	159109
845 mm	390	455	900 N	WG-G	190706
845 mm	390	455	1000 N	WG-G	192174
845 mm	390	455	1100 N	WG-G	168763
845 mm	390	455	1200 N	WG-G	192173
845 mm	390	455	1300 N	WG-G	162136
845 mm	390	455	1400 N	WG-G	166326
845 mm	390	455	1500 N	WG-G	171977
845 mm	390	455	1700 N	WG-G	166323
845 mm	390	455	1800 N	WG-G	165329

1.14 LUBRICANTS SCHMIERSTOFFE

Hydraulic Oils / Hydrauliköle

Using SENNEBOGEN approved hydraulic oils can extend the change intervals of your machine. This requires a SENNEBOGEN HydroClean filter and regularly conducted hydraulic oil analyses (Shell LubeAnalyst).

Bei Verwendung der folgenden Hydrauliköle können die Wechselintervalle bei regelmäßiger Durchführung von Hydraulikölanalysen (Shell LubeAnalyst), abhängig von den Analyseergebnissen, verlängert werden. Die Maschine muss mit SENNEBOGEN-HydroClean ausgerüstet sein.



Multigrade hydraulic oil with very good viscosity temperature behavior
Mehrbereichs-Hydrauliköl mit besonders gutem Viskositäts-Temperatur-Verhalten

Machine Type Maschinentyp	Change Interval Wechselintervall
material handling machines Materialumschlag-Maschinen	4000 h*
heavy duty cycle cranes w/o freefall winch Seilbagger ohne Freifallwinde	4000 h*
cranes / Kräne	6000 h*
equilibrium-handlers Balance-Umschlagmaschinen	6000 h*
multihandler / Multihandler	2000 h

Description Bezeichnung	Temperature Range** Temperaturbereich**	Drum Gebinde	No. Nr.
Shell Tellus S2 VA 46 (179233)	-20 °C / +50 °C	209 L	179262
		20 L	179263



Zinc-free multigrade hydraulic oil for use at extremely low temperatures
Zinkfreies Mehrbereichs-Hydrauliköl für Einsätze bei extrem niedrigen Temperaturen

Machine Type Maschinentyp	Change Interval Wechselintervall
material handling machines Materialumschlag-Maschinen	4000 h*
heavy duty cycle cranes w/o freefall winch Seilbagger ohne Freifallwinde	4000 h*
cranes / Kräne	6000 h*
equilibrium-handlers Balance-Umschlagmaschinen	6000 h*
multihandler / Multihandler	2000 h

Description Bezeichnung	Temperature Range** Temperaturbereich**	Drum Gebinde	No. Nr.
Shell Tellus S4 VX 32 (157284)	-30 °C / +40 °C	209 L	179270
		20 L	179271

*) Actual change interval depends on the results of the hydraulic oil analyses and the maintenance plan of the machine.

*) Tatsächliches Wechselintervall ist abhängig von den Ergebnissen der Hydraulikölanalysen und vom Wartungsplan der Maschine.

***) Ambient temperature **) Umgebungstemperatur

1.14 LUBRICANTS / SCHMIERSTOFFE



High-quality multigrade hydraulic oil especially suited for oil-immersed brakes
 Hochwertiges Mehrbereichs-Hydrauliköl mit besonderer Eignung für im Ölbad laufende Bremsen

Machine Type Maschinentyp	Change Interval Wechselintervall
------------------------------	-------------------------------------

heavy duty cycle cranes with freefall winch Seilbagger mit Freifallwinde	4000 h*
---	---------

Description Bezeichnung	Temperature Range** Temperaturbereich**	Drum Gebinde	No. Nr.
Shell Spirax S4 TXM (179232)	-10 °C / +50 °C	209 L	179266
		20 L	179267

BIO

hydraulic oil
Hydrauliköl



High-quality BIO - multigrade hydraulic oil especially suited for oil-immersed brackets.
 Hochwertiges BIO-Hydrauliköl mit besonderer Eignung für im Ölbad laufende Bremsen.

Machine Type Maschinentyp	Change Interval Wechselintervall
------------------------------	-------------------------------------

heavy duty cycle cranes with freefall winch Seilbagger mit Freifallwinde	4000 h*
---	---------

Description Bezeichnung	Temperature Range** Temperaturbereich**	Drum Gebinde	No. Nr.
Panolin Biofluid SBH (204129)	-10 °C / +50 °C	1000 L	204404
		200 L	204403



High-performance hydraulic oil with excellent cleaning properties
 Hochleistungs-Hydrauliköl mit hervorragenden reinigenden Eigenschaften

Machine Type Maschinentyp	Change Interval Wechselintervall
------------------------------	-------------------------------------

material handling machines Materialumschlag-Maschinen	2000 h
heavy duty cycle cranes w/o freefall winch Seilbagger ohne Freifallwinde	2000 h
cranes / Kräne	2000 h
equilibrium-handlers Balance-Umschlagmaschinen	2000 h

Description Bezeichnung	Temperature Range** Temperaturbereich**	Drum Gebinde	No. Nr.
Shell Tellus S2 M 46 (149201)	-10 °C / +40 °C	209 L	179265
		20 L	178794

1.14 LUBRICANTS / SCHMIERSTOFFE

Engine Oil / Motorenöl



High-performance diesel engine oil with improved flow at low temperatures and low-SAPS formulation to protect state-of-the-art exhaust aftertreatment systems
Hochleistungsdieselmotorenöl mit verbesserter Fließfähigkeit bei niedrigen Temperaturen und Low-SAPS-Formulation für den Schutz modernster Abgasnachbehandlungssysteme

Specifications / Spezifikationen

AECA E9/E7	Cummins	CES 20086
API CK-4	Caterpillar	ECF-3
	Deutz	DQC III-10 LA

Description Bezeichnung	Temperature Range* Temperaturbereich*	Drum Gebinde	No. Nr.
Shell Rimula R5 LE 10W-30 (179228)	-20 °C / +50 °C	209 L	179260
		20 L	179261

Gear Oils / Getriebeöle



Synthetic high-performance transmission fluid with very good lubricating properties for ultra heavy duty
Synthetisches Hochleistungsgetriebeöl mit besonders guten Schmiereigenschaften für härteste Einsatzbedingungen

Usage / Verwendung

- slewing gears / Drehgetriebe – distribution gearboxes / Pumpenverteilergetriebe
- winch gears / Windengetriebe – crawler gearboxes / Raupenfahrgetriebe
- rail gearboxes / Schienenfahrgetriebe

Description Bezeichnung	Temperature Range* Temperaturbereich*	Drum Gebinde	No. Nr.
Shell Omala S4 GXV 220 (179227)	-30 °C / +50 °C	209 L	180576
		20 L	179268



High-quality special transmission fluid for continuous use with consistent comfort
Hochwertiges Spezialgetriebeöl für dauerhaften Einsatz bei gleichbleibendem Anwendungskomfort

Usage / Verwendung

- slewing gear brakes / Drehgetriebe-Bremse

Description Bezeichnung	Temperature Range* Temperaturbereich*	Drum Gebinde	No. Nr.
Shell Spirax S2 ATF AX (179229)	-30 °C / +50 °C	209 L	178793
		20 L	179272

*) Ambient temperature
 *) Umgebungstemperatur

1.14 LUBRICANTS / SCHMIERSTOFFE



High-performance transmission fluid for transmissions and axle drives for moderate to heavy duty

Hochleistungsgetriebeöl für Getriebe und Achsantriebe bei moderaten bis hoch belastenden Einsatzbedingungen

Usage / Verwendung

- wheel gears / Radnabengetriebe
- axle differentials / Achsdifferenzialgetriebe
- countershaft transmission / Vorgelegegetriebe

Description <i>Bezeichnung</i>	Temperature Range* <i>Temperaturbereich*</i>	Drum <i>Gebinde</i>	No. <i>Nr.</i>
Shell Spirax S3 ALS 80W-90 (179230)	-30 °C / +50 °C	209 L	180578
		20 L	179273

Greases / Fette



Grease for high temperature with very good adhesion for open gear applications
Hochtemperaturschmierstoff mit sehr guter Adhäsion für außenliegende Getriebe

Usage / Verwendung

- slewing ring outside / Drehkranzverzahnung außen

Description <i>Bezeichnung</i>	Temperature Range* <i>Temperaturbereich*</i>	Drum <i>Gebinde</i>	No. <i>Nr.</i>
Shell Gadus S2 OGH (197222)	-20 °C / +50 °C	18 kg	179278
		1 kg	185697
		400 g	253233



High performance multipurpose extreme pressure grease



Hochleistungs-Mehrzweckfett mit hervorragenden Extreme-Pressure (EP)-Eigenschaften

Usage / Verwendung





- central lubrication systems / Zentralschmieranlagen
- slewing ring rollings / Drehkranz Wälzlager
- slewing ring inside / Drehkranzverzahnung innen
- undercarriage telescopic systems / Unterwagenteleskopierung

Description <i>Bezeichnung</i>	Temperature Range* <i>Temperaturbereich*</i>	Drum <i>Gebinde</i>	No. <i>Nr.</i>
Shell Gadus S2 V 220 2 (179226)	-20 °C / +50 °C	18 kg	179275
		5 kg	179276
		400 g	179277

1.14 LUBRICANTS / SCHMIERSTOFFE

	Description Bezeichnung	Content Inhalt	Notes Bemerkung	No. Nr.
	slewing ring grease Drehkranzfett	5 kg	OKS 490	047485
	slewing ring grease Drehkranzfett	1 kg	OKS 490	124847
	multi-purpose grease Mehrzweckfett	400 g	Spectron F020	018079

Gear and Rope Lubricants / Zahnrad- und Seilschmierstoffe

	Description Bezeichnung	Content Inhalt	Notes Bemerkung	No. Nr.
	gear spray Zahnradspray	500 ml	OKS 491	011429
	rope oil Seilöl	30 l	RL-B 30	162867
	rope oil Seilöl	10 l	RL-B 10	162866
	rope lube spray Seilspray	600 ml	RL-S	162868

LubeAnalyst / Ölproben-Set



Shell LubeAnalyst oil sampling set
 - for regular analysis of hydraulic oils
 - consisting of 10 samples, incl. analysis
 Shell LubeAnalyst - Ölproben-Set
 - für regelmäßige Analyse der verwendeten Hydrauliköle
 - bestehend aus 10 Proben, inklusive Analyse

Description / Bezeichnung	No. / Nr.
LubeAnalyst / Ölproben Set	190279
oil extraction tool / Ölentnahme Werkzeug	188020

1.15 COOLANT ANTIFREEZE

KÜHLERFROSTSCHUTZ

SenProtect Antifreeze

SenProtect Antifreeze is a universal, ready-to-use product. The right mixture of water and propylene glycol always ensures sufficient frost protection and a higher boiling point. This increases machine availability and permanently improves the performance of the cooling system.

SenProtect Antifreeze also protects against pitting and corrosion, which extends the lifetime of the entire cooling system.

- 4000 hours service interval
- Conforms ASTM D-6210
- Frost and boiling protection
- Aluminum and solder protection
- Optimized performance of the cooling system
- Increased lifetime of the water pump
- Mixable with all common coolants
- Ready-to-use mixture
- Lower maintenance costs
- Increased machine availability
- For SENNEBOGEN machines with Cummins or Deutz engines

SenProtect Antifreeze ist ein universelles, gebrauchsfertiges Produkt. Eine angemessene Mischung aus Wasser und Propylenglykol sorgt stets für ausreichenden Frostschutz und erhöhten Siedepunkt. Damit wird die Maschinenverfügbarkeit erhöht und die Leistungsfähigkeit des Kühlsystems dauerhaft verbessert.

SenProtect Antifreeze schützt zudem vor Lochfraß und Korrosion, womit die Lebensdauer des gesamten Kühlsystems verlängert wird.

- 4000 Stunden Serviceintervall
- Entspricht ASTM D-6210
- Frost- und Siedeschutz
- Aluminium- und Lötstellenschutz
- Optimierte Leistung des Kühlsystems
- Erhöhte Lebensdauer der Wasserpumpe
- Mischbar mit allen gängigen Kühlmitteln
- Gebrauchsfertige Mischung
- Weniger Wartungskosten
- Erhöhte Maschinenverfügbarkeit
- Für SENNEBOGEN Maschinen mit Cummins- oder Deutz-Motoren

-37 °C
Premix 50/50

SenProtect Antifreeze SE-No. 187301

Premix 50/50 (20 l)



1.16 DIN-SCREWS

DIN-SCHRAUBEN



These DIN screw kits consist of more than 650 articles, composed of more than 45 different types of screws. In combination with the DIN small components kit, they ensure that you always have suitable mounting material for SENNEBOGEN machines anytime and anywhere. DIN screws sets are available in three different versions, each with different screw sizes. Detailed summaries are listed in the appendix.

Mit diesen DIN-Schrauben-Sets erhalten Sie insgesamt über 650 Teile, zusammengestellt aus mehr als 45 verschiedenen Schraubenvarianten. Zusammen mit dem DIN-Kleinteile-Set sind Sie damit jederzeit und überall mit stets passendem Befestigungsmaterial für SENNEBOGEN-Maschinen ausgestattet. DIN-Schrauben-Sets sind in drei verschiedenen Ausführungen mit jeweils unterschiedlichen Schraubengrößen erhältlich. Detaillierte Inhaltsangaben haben wir für Sie im Anhang aufbereitet.

Description Bezeichnung	Content Inhalt	No. Nr.
DIN screw kit small DIN-Schrauben-Set klein	M5 x 10 – M10 x 50	056270
DIN screw kit middle DIN-Schrauben-Set mittel	M10 x 55 – M14 x 90	056271
DIN screw kit large DIN-Schrauben-Set groß	M16 x 30 – M16 x 100	056272

1.17 DIN SMALL COMPONENTS

DIN-KLEINTEILE



Description Bezeichnung	No. Nr.
This DIN small components kit consists of more than 2000 parts, composed of more than 34 different lock washers, large diameter washers, spacer disks, screw nuts and self-locking screw nuts. In combination with the DIN screw kits, this kit ensures that you always have suitable mounting material for SENNEBOGEN machines anytime and anywhere. Detailed summaries are listed in the appendix.	056273
<i>Mit diesem DIN-Kleinteile-Set erhalten Sie über 2000 Teile, zusammengestellt aus mehr als 34 verschiedenen Federringen, Karoseriescheiben, Ausgleichscheiben, Muttern und selbstsichernden Muttern. Ergänzend zu den DIN-Schrauben-Sets sind Sie mit diesem Set jederzeit und überall mit stets passendem Befestigungsmaterial für SENNEBOGEN-Maschinen ausgestattet. Detaillierte Inhaltsangaben haben wir für Sie im Anhang aufbereitet.</i>	

1.18 CENTRAL LUBRICATION SYSTEM

ZENTRALSCHMIERUNG



Each accessory kit for central lubrication systems includes more than 80 single components for repairs. In addition to all common spare parts for central lubrication systems, they also include basic tools, which enable you to carry out repairs professionally. The accessory kits are available in three different versions. Detailed summaries are listed in the appendix.

Die Zubehör-Sets für Zentralschmieranlagen enthalten jeweils mehr als 80 Einzelkomponenten für Reparaturzwecke. Neben allen gängigen Ersatzteilen für Zentralschmieranlagen erhalten Sie auch notwendige Grundwerkzeuge. Somit sind Sie stets gerüstet, Reparaturarbeiten fachgerecht auszuführen. Die Zubehör-Sets sind in drei verschiedenen Ausführungen erhältlich. Detaillierte Inhaltsangaben haben wir für Sie im Anhang aufbereitet.

Description Bezeichnung	Usage Verwendung	No. Nr.
central lubrication kit Zentralschmierung-Set	Beka Max (825 – 840)	113541
central lubrication kit Zentralschmierung-Set	Beka Max (880)	109049
central lubrication kit Zentralschmierung-Set	Lincoln	076274

1.19 O-RING KIT

O-RING-SET



The SENNEBOGEN O-ring kits include O-rings in size from 0 – 70 mm, for repair work on SENNEBOGEN machines. They provide the basic equipment to ensure that you have the suitable O-ring available anytime and anywhere. O-ring sets are available in various scopes of supply which complete each other modularly.

Die SENNEBOGEN O-Ring-Sets beinhalten O-Ringe in den Größen von 0 – 70 mm, die für Reparaturzwecke an SENNEBOGEN-Maschinen infrage kommen. Somit erhalten Sie eine Grundausstattung, mit der Sie jederzeit und überall stets den passenden O-Ring zur Hand haben. O-Ring-Sets sind in verschiedenen Umfängen erhältlich, welche sich modular ergänzen.

Description Bezeichnung	Content Inhalt	No. Nr.
O-ring kit O-Ring-Set	2 boxes / 2 Koffer 165 O-rings / 165 O-Ringe (0 – 70 mm) 4 AC O-rings / 4 Kältemittel-O-Ringe 11 pipe mounting rings / 11 Rohrmontageringe includes 271477 + 271478 / beinhaltet 271477 + 271478	217476
O-ring kit – basic O-Ring-Set – Basis	1 box / 1 Koffer 99 O-rings / 99 O-Ringe (0 – 70 mm) 4 AC O-rings / 4 Kältemittel-O-Ringe	217477
O-ring kit – extension O-Ring-Set – Erweiterung	1 box / 1 Koffer 66 O-rings / 66 O-Ringe (0 – 70 mm) 11 pipe mounting rings / 11 Rohrmontageringe	217478

**recommended
empfohlen**

1.20 O-RINGS (SINGLE PIECES)

O-RINGE (EINZELN)



Description Bezeichnung	Dimensions Maße	Connection Anschlussmaß	No. Nr.
O-ring / O-Ring	18,66 mm x 3,53 mm	1/2"	030306
O-ring / O-Ring	25,00 mm x 3,53 mm	3/4"	030307
O-ring / O-Ring	32,92 mm x 3,53 mm	1"	030308
O-ring / O-Ring	37,70 mm x 3,53 mm	1 1/4"	030309
O-ring / O-Ring	47,22 mm x 3,53 mm	1 1/2"	030314
O-ring / O-Ring	56,75 mm x 3,53 mm	2"	040027

1.21 SEALS FOR GEAR PUMPS

DICHTUNGEN FÜR ZAHNRADPUMPEN

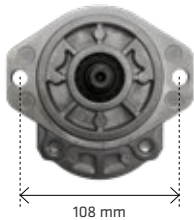

Description
Bezeichnung

Seal No.
Dichtung Nr.

Gear pump type 1
Zahnradpumpe Typ 1

115107



Gear pump type 2
Zahnradpumpe Typ 2

089002

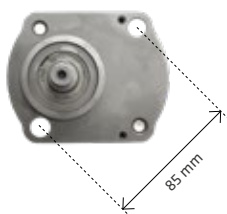











Gear pump type 3
Zahnradpumpe Typ 3











045966

2.1 VALVES











VENTILE

	Description <i>Bezeichnung</i>	Connector <i>Anschluss</i>	Specification <i>Spezifikation</i>	No. <i>Nr.</i>
	3/2-way valve <i>3/2-Wegeventil</i>	DT04	27 V / 20 W	189428
	3/2-way valve <i>3/2-Wegeventil</i>	DT04	27 V / 22 W	225613
	3/2-way valve <i>3/2-Wegeventil</i>	DT04	27 V / 0,84 A	182413
	3/2-way valve pressure regulation <i>3/2-Wege-Prop.-Druckregelung</i>	DT04	24 V / 0,8 A	192724
	4/2-way valve <i>4/2-Wegeventil</i>	DT04	27 V / 20 W	189429
	4/2-way valve <i>4/2-Wegeventil</i>	DT04	27 V / 0,84 A	182414
	2/2-way valve <i>2/2-Wegeventil</i>	JPT	24 V / 27 W	101808
	2/2-way valve <i>2/2-Wegeventil</i>	JPT	24 V / 27 W	148966
	3/2-way valve <i>3/2-Wegeventil</i>	JPT	24 V / 14 W	106995
	3/2-way valve <i>3/2-Wegeventil</i>	JPT	24 V / 20 W	108741
	3/2-way valve <i>3/2-Wegeventil</i>	JPT	24 V / 20 W	113782



2.1 VALVES / VENTILE

	Description <i>Bezeichnung</i>	Connector <i>Anschluss</i>	Specification <i>Spezifikation</i>	No. <i>Nr.</i>
	3/2-way valve <i>3/2-Wegeventil</i>	JPT	27 V / 20 W	159354
	3/2-way valve <i>3/2-Wegeventil</i>	JPT	27 V / 22 W	225612
	3/2-way valve <i>3/2-Wegeventil</i>	JPT	27 V / 0,84 A	159355
	4/2-way valve <i>4/2-Wegeventil</i>	JPT	24 V / 14 W	107419
	4/2-way valve <i>4/2-Wegeventil</i>	JPT	24 V / 20 W	108726
	4/2-way valve <i>4/2-Wegeventil</i>	JPT	27 V / 20 W	159380
	4/2-way valve <i>4/2-Wegeventil</i>	JPT	27 V / 0,84 A	159379
	4/2-way valve with APL <i>4/2-Wegeventil mit APL</i>	JPT	27 V / 1,52 A	121287
	4/3-way valve <i>4/3-Wegeventil</i>	JPT	24 V / 31 W	107428
	4/3-way valve <i>4/3-Wegeventil</i>	JPT	27 V / 1,07 A	106992
	4/3-way reverse flow valve <i>4/3-Wege-Reversierventil</i>	JPT	27 V / 1,52 A	118846







2.1 VALVES / VENTILE

	Description <i>Bezeichnung</i>	Connector <i>Anschluss</i>	Specification <i>Spezifikation</i>	No. <i>Nr.</i>
	3/2-way valve <i>3/2-Wegeventil</i>	DIN 43650	24 V / 12 W	025918
	3/2-way valve <i>3/2-Wegeventil</i>	DIN 43650	24 V / 14 W	085194
	3/2-way valve <i>3/2-Wegeventil</i>	DIN 43650	24 V / 14 W	081407
	3/2-way valve, with manual override <i>3/2-Wegeventil, mit Nothandbetätigung</i>	DIN 43650	24 V / 12 W	023099
	3/2-way valve, with manual override <i>3/2-Wegeventil, mit Nothandbetätigung</i>	DIN 43650	24 V / 14 W	081409
	3/2-way valve <i>3/2-Wegeventil</i>	DIN 43650	27 V / 22 W	225611
	4/2-way valve <i>4/2-Wegeventil</i>	DIN 43650	24 V / 14 W	085196
	4/2-way valve <i>4/2-Wegeventil</i>	DIN 43650	24 V / 14 W	081408
	4/2-way valve <i>4/2-Wegeventil</i>	DIN 43650	24 V / 20 W	080751
	4/3-way valve <i>4/3-Wegeventil</i>	DIN 43650	24 V / 31 W	079177

2.1 VALVES / VENTILE



	Description <i>Bezeichnung</i>	Connector <i>Anschluss</i>	Specification <i>Spezifikation</i>	No. <i>Nr.</i>
	4/3-way valve <i>4/3-Wegeventil</i>	DIN 43650	24 V / 1,29 A	079179
	S5/3-way valve <i>S5/3-Wegeventil</i>	DIN 43650	24 V / 0,88 A	118222

Pressure Limitation Valves / *Druckbegrenzungsventile*





	Description <i>Bezeichnung</i>	Notes <i>Bemerkung</i>	Specification <i>Spezifikation</i>	No. <i>Nr.</i>
	pressure limitation valve <i>Druckbegrenzungsventil</i>	350 bar, 7/8" 14 UNF 2A	pmax 380 bar Qmax 113 l/min	048124
	pressure limitation valve <i>Druckbegrenzungsventil</i>	420 bar, M14 x 1	MHDBD 04 K2- 1X/420VDA-168	183071
	pressure limitation valve <i>Druckbegrenzungsventil</i>	420 bar, M24 x 1	VMR-16-N-420	200377
	pressure limitation valve <i>Druckbegrenzungsventil</i>	420 bar, M28 x 1	VMR-22-FC-N-420	200378
	pressure limitation valve <i>Druckbegrenzungsventil</i>	420 bar, M30 x 1,5	VMR-22-LG-N-420	194552
	pressure limitation valve <i>Druckbegrenzungsventil</i>	pressure sequence <i>Druckzuschaltstufe</i>	MHDBB 22 K9- 2X/420VLG01	050191

2.1 VALVES / VENTILE

Valve Cartridges / Ventilpatronen

	Description <i>Bezeichnung</i>	Usage <i>Verwendung</i>	No. <i>Nr.</i>
	valve cartridge <i>Ventilpatrone</i>	pressure gauge <i>Druckwaage</i>	075624
	valve cartridge <i>Ventilpatrone</i>	grab control, 350 bar <i>Greifersteuerung 350 bar</i>	087276
	valve cartridge <i>Ventilpatrone</i>	check valve <i>Rückschlagventil</i>	126262

Pressure Reduction Valves / Druckminderventile

	Description <i>Bezeichnung</i>	Notes <i>Bemerkung</i>	No. <i>Nr.</i>
	pressure reduction valve <i>Druckminderventil</i>	PRDB-LEN	082530
	pressure reduction valve <i>Druckminderventil</i>	PP2P-W3/C3202400E4	118667
	pressure reduction valve <i>Druckminderventil</i>	ADM 1-30	019332
	pressure reduction valve <i>Druckminderventil</i>	DF-PRP-00-0450	072233

2.2

QUICK LOCK COUPLINGS SCHNELLVERSCHLUSSKUPPLUNGEN

Threaded Couplings Metric / Schraubverschlüsse metrisch Internal Thread / Innengewinde



Thread <i>Anschluss</i>	C. Thread <i>Verbindung</i>	Plug <i>Stecker</i>	Cap <i>Schutzkappe</i>	Sleeve <i>Muffe</i>	Cap <i>Schutzkappe</i>
M22 x 1,5	Rd 35 x 2				
		008851	008867	008875	008873
M30 x 1,5	Rd 54 x 3				
		008850	008866	008909	008874

Threaded Couplings Metric / Schraubverschlüsse metrisch External Thread / Außengewinde



Thread <i>Anschluss</i>	C. Thread <i>Verbindung</i>	Plug <i>Stecker</i>	Cap <i>Schutzkappe</i>	Sleeve <i>Muffe</i>	Cap <i>Schutzkappe</i>
M18 x 1,5	Rd 35 x 2				
				114845	008873
M22 x 1,5	Rd 35 x 2				
		103366	008867		
M36 x 2	Rd 54 x 3				
		103367	008866	113994	008874
M42 x 2	Rd 54 x 3				
		103422	008866		

2.2 QUICK LOCK COUPLINGS / SCHNELLVERSCHLUSSKUPPLUNGEN

Threaded Couplings Inch / Schraubverschlüsse Zollgewinde



DN	Thread Anschluss	C. Thread Verbindung	Plug Stecker	Cap Schutzkappe	Sleeve Muffe	Cap Schutzkappe
7	1/4"	M30 x 2				
			131814	131816	131812	131818
13	1/2"	M40 x 4				
			131711	131713	131709	131715
17	1"	M50 x 3				
			131815	131817	131813	131819
21	1-1/4"	M58 x 3				
			131710	131712	131708	131714

Quick Lock Inch / Steckverschlüsse Zollgewinde



DN	Thread Anschluss	C. Thread Verbindung	Plug Stecker	Cap Schutzkappe	Sleeve Muffe	Cap Schutzkappe
13	1/2"	-				
			068093	068099	068090	068096
17	1"	-				
			068094	068100	248949	068097
21	1-1/4"	-				
			167588	068101	167589	068098

2.3 SAE FLANGE KIT

SAE-FLANSCH-SET



Description Bezeichnung

No.
Nr.

The SAE flange kit includes extension and locking devices suitable for all hydraulic hoses and tubes used in SENNEBOGEN machines. This kit enables you to extend or cap tubes and hoses anytime and anywhere. Detailed summaries are listed in the appendix.

056274

Das SAE-Flansch-Set beinhaltet Verlängerungs- und Verschluss-elemente, passend für alle Hydraulikschläuche und -leitungen an SENNEBOGEN-Maschinen. Mit diesem Set sind Sie jederzeit und überall in der Lage, Leitungen und Schläuche zu verlängern oder zu verschließen. Detaillierte Inhaltsangaben haben wir für Sie im Anhang aufbereitet.

2.4 FITTING KIT

VERSCHRAUBUNGEN-SET



Description Bezeichnung

No.
Nr.

The fitting kit includes more than 135 fittings in over 42 different versions. This basic kit with all common fittings used in SENNEBOGEN machines enables you to carry out repairs easily anytime and anywhere. Repairs can be carried out quickly without purchasing a range of small parts.

040474

Das Verschraubungen-Set beinhaltet über 135 Verschraubungen in mehr als 42 verschiedenen Ausführungen. Mit dieser Grundausstattung mit allen gängigen Verschraubungen für SENNEBOGEN-Maschinen sind Sie jederzeit und überall in der Lage, Reparaturen schnell und ohne umständliche Beschaffung diverser Kleinteile durchzuführen. Detaillierte Inhaltsangaben haben wir für Sie im Anhang aufbereitet.

2.5 VARIO TOOL-TOOL KIT

VARIO TOOL-WERKZEUGSATZ



Description Bezeichnung

No.
Nr.

This tool kit includes wear parts, tools and cleaning utensils for servicing the SENNEBOGEN Vario Tool.

174686

Dieser Werkzeugsatz beinhaltet Verschleißteile, Werkzeuge und Reinigungsutensilien für Servicearbeiten am SENNEBOGEN Vario Tool.

Content / Inhalt

- 2 x valve keys / Ventilschlüssel
- 1 x wire brush / Drahtbürste
- 1 x degreaser / Reinigungsmittel
- 4 x rubber buffer / Gummipuffer
- 6 x 5 O-rings / O-Ringe

2.6 VACUUM PUMP

VAKUUMPUMPE



Description Bezeichnung

No.
Nr.

The vacuum pump introduces preloaded pressure into the hydraulic tank to prevent airlocks. Oil is retained by creating a vacuum in the hydraulic tank. Pressure support when venting an empty fuel system.

054603

- dry-running 30 l compressor
- 4-5 bar pressure / 850 mbar vacuum
- designed for continuous operation

Die Vakuumpumpe dient der Erzeugung von Vorspanndruck im Hydrauliktank zur Vermeidung von Kavitation. Ölrückhaltung durch Aufbau eines Vakuums im Hydrauliköltank. Druckunterstützung beim Entlüften einer leeren Kraftstoffanlage.

- trocken laufender 30-l-Kompressor
- 4-5 bar Druck / 850 mbar Vakuum
- ausgelegt für Dauerbetrieb



nozzle for vacuum pump 054603
Mundstück für Vakuumpumpe 054603

087150

2.7 HYDRAULIC MEASURING BOX HYDRAULIK-MESSKOFFER



Description Bezeichnung

No.
Nr.

This measuring device impresses with its easy operation and high usage value. It has an illuminated display, a large internal memory and a powerful battery. Besides measuring oil pressure at channel P1, it is also possible to measure temperature, flow volume and speed at channel P2.

160651

Dieses Messgerät besticht durch einfache Bedienung und einen hohen Nutzwert.

Es verfügt über ein beleuchtetes Display, einen großen internen Speicher und einen leistungsfähigen Akku. Neben Öldrücken von Messkanal P1 können am Messkanal P2 auch Temperatur, Durchflussmenge und Drehzahl gemessen werden.

2.8 MEASURING TURBINE MESSTURBINE



Description Bezeichnung

No.
Nr.

The ideal addition to the hydraulic measuring box for measuring the flow volume with all the necessary adaptors. Measuring range from 25 to 600 l/min., thread S30 / M 42x2, pmax = 400 bar. Equipped with mini measuring-screw coupling, a P/T-measuring coupling of the screw series 1620 and an inductive receiver with amplifier.

160986

Die ideale Ergänzung zum Hydraulikmesskoffer zur Ermittlung der Durchflussmenge mit den erforderlichen Adaptern. Messbereich von 25 bis 600 l/min., Gewinde S30 / M 42x2, pmax = 400 bar. Bestückt mit einer Minimesse-Schraubkupplung, einer P/T Messkupplung der Schraubreihe 1620 und einem Induktivaufnehmer mit Verstärker.



Individual measuring turbines from set 160986
Messturbine einzeln aus Set 160986

160652

2.9 MEASURING BOX-STARTER KIT

MESSKOFFER-STARTERKIT



Description / Bezeichnung

This measurement kit contains the basic equipment for analysis work on hydraulic systems in SENNEBOGEN machines. Recommended by SENNEBOGEN service technicians.

Dieser Messkoffer beinhaltet die Grundausrüstung für Analysearbeiten an hydraulischen Systemen in SENNEBOGEN Maschinen. Von SENNEBOGEN Servicetechnikern empfohlen.

Content / Inhalt

1 x hydraulic gauge / Hydraulikmessgerät (160651)
 1 x volt meter / Voltmeter
 1 x revolution counter / Handdrehzahlmessgerät
 2 x oil pressure manometer / Öldruckmanometer
 measuring tubes / Messleitungen
 couplings / Anschlussstücke

No. / Nr.

191734

2.10 OIL PRESSURE MANOMETER SET

ÖLDRUCK-MANOMETER-SET



Description / Bezeichnung

With mini measuring tubes. Pressure range from 0 – 60 bar and 0 – 600 bar, incl. 1 spare tube and 2 additional couplings.

Mit Minimessschläuchen. Druckbereich von 0 bis 60 bar und 0 bis 600 bar, inkl. 1 Ersatzschlauch und 2 Zusatzkupplungen.

No. / Nr.

057011

2.11 DIAGNOSTIC TOOL KIT FPT

DIAGNOSEKOFFER FPT



Description / Bezeichnung

This tool kit contains the hardware (without laptop) and software that is required to check the engine management system of the FPT NEF 45 engine.*

*Dieser Koffer beinhaltet die Hardware (ohne Laptop) und Software, die für die Überprüfung des Motormanagementsystems des FPT NEF 45 Motors benötigt wird.**

Content / Inhalt

1 x HW PT-BOX + power supply / HW PT-BOX inkl. Stromversorgung
 1 x Cable 30 pins / Kabel 30-polig
 2 x USB Cable (1.8 m + 4.5 m) / USB-Kabel (1,8 m + 4,5 m)
 1 x Plug / Stecker
 1 x Prepaid Card 206147 (incl. 10 coins) / 1 x Prepaid Karte 206147 (inkl. 10 Coins)
 1 x Software Download Link / 1 x Software Download Link

No. / Nr.

206144

3.1 SWITCHES





SCHALTER





	Usage, Switch Positions <i>Verwendung, Schalterstellungen</i>	No. <i>Nr.</i>		Usage, Switch Positions <i>Verwendung, Schalterstellungen</i>	No. <i>Nr.</i>
	additional limiter-stick <i>Zusatzbegrenzung Stiel, Hub</i> 0 - RV	110102		engine start <i>Motor Start</i> 0 - T	110671
	all-wheel steering <i>Allradlenkung</i> 0 - R	110582		fan reversal <i>Lüfterumkehr</i> R - 0 - T	110189
	automatic idle <i>Leerlaufautomatik</i> 0 - R	110110		floating axle <i>Pendelachse</i> 0 - R	110191
	boom damping <i>Auslegerdämpfung</i> 0 - R	110101		floating axle <i>Pendelachse</i> 0 - R - R	176567
	boom floating position <i>Auslegerschwimmstellung</i> 0 - R	110107		front panel wiper <i>Scheibenwischer Front unten</i> 0 - R - T	110114
	cabin down <i>Kabine senken</i> 0 - TV	110263		fuel filter heater <i>Dieselfilterheizung</i> 0 - R	110179
	cabin forward <i>Kabine vor</i> 0 - TV	110264		grab control <i>Greifersteuerung</i> 0 - R	110105
	cabin up / down <i>Kabine heben / senken</i> T - 0 - T	110231		grab function on / off <i>Greiferfunktion ein / aus</i> 0 - R	110106
	cabin up / down <i>Kabinenneigung heben / senken</i> T - 0 - T	110230		grading blade <i>Planierschild</i> 0 - R	110185
	cabin up <i>Kabine heben</i> 0 - TV	110262		load limit sensing control <i>Grenzlastregelung</i> 0 - RV	110125
	cabine movement direction <i>Kabinenbewegung</i> 0 - R	198931		lubrication slewing ring <i>Drehkranzschmierung</i> 0 - T	110109
	central lubrication <i>Zentralschmierung</i> 0 - T	110108		magnet unit <i>Magnetanlage</i> 0 - RV	110103
	direction indicator <i>Blinker</i> R - 0 - R	110177		outrigger left <i>Abstützung links</i> 0 - T	110183
	ECO-switch <i>ECO-Schaltung</i> 0 - R	110111		outrigger left, MaxCab 2 <i>Abstützung links, MaxCab 2</i> 0 - T	205321
	emergency steering <i>Notlenkung</i> T - 0 - T	158601		outrigger right <i>Abstützung rechts</i> 0 - T	110184
	emergency switch ULM <i>Notbetätigung ULM</i> T - 0 - T	177274		outrigger right, MaxCab 2 <i>Abstützung rechts, MaxCab 2</i> 0 - T	198807

3.1 SWITCHES / SCHALTER



	Usage, Switch Positions <i>Verwendung, Schalterstellungen</i>	No. <i>Nr.</i>		Usage, Switch Positions <i>Verwendung, Schalterstellungen</i>	No. <i>Nr.</i>
	overload <i>Überlast</i> 0 - R	110104		unlock driving (crawler) <i>Freigabe Fahren (Raupe)</i> 0 - VR	110532
	parking brake panning <i>Parkbremse Schwenken</i> 0 - R	110190		unlock winch 1 <i>Freigabe Winde 1</i> 0 - R	110331
	parking brake <i>Parkbremse</i> 0 - R	110234		unlock winch 2 <i>Freigabe Winde 2</i> 0 - R	110332
	regeneration DPF <i>Regeneration DPF</i> T - 0 - R	177751		Vario Tool lock <i>Vario Tool Verriegelung</i> T - 0 - T	110196
	roof panel wiper <i>Scheibenwischer Dachscheibe</i> 0 - R - R	110116		Vario Tool unlock <i>Vario Tool Freigabe</i> 0 - RV	110173
	strobe light <i>Rundumleuchte Kabine</i> 0 - R	110113		warning light <i>Warnblinkanlage</i> 0 - R	110112
	switch Euro <i>Umschaltung Euro</i> 0 - RV	110209		winch 2 up / down <i>Winde 2 heben / senken</i> T - 0 - T	205562
	switch tele - winch 2 <i>Umschaltung Tele - Winde 2</i> 0 - R	110229		winch gear 1 / 2 <i>Winde Gang 1 / 2</i> 0 - R	110228
	switch telescope <i>Umschaltung Teleskop</i> 0 - RV	186923		winch gear 1 / 2 <i>Winde Gang 1 / 2</i> 0 - R	110333
	tele UTW on / off <i>Tele UTW einfahren / ausfahren</i> T - 0 - T	110233		windscreen wiper <i>Scheibenwischer Frontscheibe</i> 0 - R - R	110118
	travel slow / fast <i>Fahren langsam / schnell</i> 0 - R	110186		windscreen washer <i>Waschanlage Frontscheibe</i> 0 - T	110117
	unlock hydraulic <i>Freigabe Hydraulik</i> 0 - R	110236		work light <i>Arbeitsscheinwerfer</i> 0 - R	110121
	unlock mounting <i>Freigabe Rüsten</i> 0 - VT	110539		additional function ZH-O <i>Zusatzhydraulik</i> 0 - R	110158
	unlock outrigger <i>Freigabe Abstützung</i> 0 - R	110349		air condition <i>Klimaanlage</i> 0 - R	110152
	unlock slewing gear <i>Drehwerkfreilauf</i> 0 - R	110337		cabin up / down <i>Kabine heben / senken</i> T - 0 - T	110160
	unlock travel <i>Freigabe fahren</i> 0 - R	110235		driving slow / fast <i>Fahren langsam / schnell</i> 0 - R	110164

3.1 SWITCHES / SCHALTER





	Usage, Switch Positions <i>Verwendung, Schalterstellungen</i>	No. <i>Nr.</i>
	EMR <i>EMR</i> 0 - T	110147
	fan reversal <i>Lüfterumkehr</i> 0 - T	110167
	floating axle <i>Pendelachse</i> 0 - R	110162
	level cylinder front axle <i>Niveauezylinder Vorderachse</i> T - 0 - T	110159
	overload LMB <i>Überdruck LMB</i> 0 - RV	110157
	parking brake <i>Parkbremse</i> 0 - R	110163
	quick change device <i>Gerätehalter</i> 0 - T	110161
	roof washer <i>Waschanlage Dach</i> 0 - R - T	110150
	round lightning <i>Rundumleuchte</i> 0 - R	110154
	steering mode <i>Lenkarten</i> 0 - R - R	110169
	warning light <i>Warnblinkanlage</i> 0 - R	110155
	washer back <i>Waschanlage Heck</i> 0 - R - T	110151
	windscreen washer <i>Waschanlage Frontscheibe</i> 0 - R - T	110149
	work light <i>Arbeitscheinwerfer</i> 0 - R	110153
	modular switch <i>Modulschalter</i> 0 - T	014007
	toggle switch <i>Wechselschalter</i> 0 - R	014008

	Usage, Switch Positions <i>Verwendung, Schalterstellungen</i>	No. <i>Nr.</i>
	combination switch <i>Kombischalter</i> 0 - R - T	045266
	push-button switch <i>Drucktastenschalter</i> T - 0 - T	048315
	on-/off-switch <i>Ein-/Aus-Schalter</i>	067898
	switch <i>Schalter</i> 0 - R	110293

Ignition Locks / Zündschlösser

	Description <i>Bezeichnung</i>	No. <i>Nr.</i>
	ignition lock / Zündschloss keys in "P" and "0" removable <i>Schlüssel in „P“ und „0“ abziehbar</i>	027101
	ignition lock / Zündschloss keys only in "0" removable <i>Schlüssel nur in „0“ abziehbar</i>	110172

Emergency Stop Switches / Not-Aus-Schalter

	Description <i>Bezeichnung</i>	No. <i>Nr.</i>
	emergency stop switch <i>Not-Aus-Schalter</i>	072528
	emergency stop switch <i>Not-Aus-Schalter</i>	245188
	emergency stop switch <i>Not-Aus-Schalter</i>	247396
	emergency stop switch, armrest <i>Not-Aus-Schalter, Armlehne</i>	052787
	emergency stop switch <i>Not-Aus-Schalter</i>	074064













3.1 SWITCHES / SCHALTER

Other Switches / Sonstige Schalter











	Description <i>Bezeichnung</i>	No. <i>Nr.</i>		Description <i>Bezeichnung</i>	No. <i>Nr.</i>
	lever switch, cabin up / down <i>Hebeltaster, Kabine heben / senken</i>	155092		potentiometer <i>Potentiometer</i> 0 - 10k Ohm, PC262	145923
	lever switch <i>Hebeltaster</i> 0 - R	155107		safety switch, armrest <i>Sicherheitsschalter, Armlehne</i>	033723
	selection switch, 3 steps <i>Wahlschalter, 3-stufig</i>	015215		4-point outrigger <i>4-Punkt Abstützung</i>	029354
	hour counter <i>Betriebsstundenzähler</i> Ø = 52 mm	047820		AC control panel <i>Bedienelement Klimaanlage</i>	171393
	hour counter <i>Betriebsstundenzähler</i> 54 mm x 29 mm x 50 mm	026823		rocker switch <i>Wippentaster</i>	131691
	interval switch <i>Intervallschalter</i> 24 V, 2 - 20 l/min	040177		rocker switch, 2-pole <i>Wippschalter, 2-polig</i>	135002
	potentiometer, hand throttle <i>Potentiometer, Handgas</i> M = 2,5 Nm	089666		push-button, flat <i>Drucktaste, flach</i> M22-D-S	072550
	potentiometer, accelerator pedal <i>Potentiometer, Fußgas</i> 0 - 10k Ohm	031524		key button <i>Schlüsseltaster</i> M22-WS	072551
	trimming potentiometer <i>Gaspotentiometer</i>	086331		button, red, 1-pole <i>Drucktaster, rot, einpolig</i>	198894
	potentiometer <i>Potentiometer</i> M22-R10K	072567			

3.2 PRESSURE SWITCHES

DRUCKSCHALTER







	Usage <i>Verwendung</i>	Pressure Range <i>Druckbereich</i>	Preset <i>Einstelldruck</i>	Thread <i>Gewinde</i>	No. <i>Nr.</i>
	change-over-contact <i>Wechselkontakt</i>	1 – 10 bar	5 bar	M12 x 1,5	037692
	change-over-contact <i>Wechselkontakt</i>	1 – 10 bar	5 bar	G 1/4"	037693
	change-over-contact <i>Wechselkontakt</i>	10 – 50 bar	18 bar	G 1/4"	074011
	change-over-contact <i>Wechselkontakt</i>	50 – 200 bar	100 bar	M10 x 1	020098
	change-over-contact <i>Wechselkontakt</i>	20 – 400 bar	400 bar	G 1/4"	095675
	change-over-contact <i>Wechselkontakt</i>	10 – 320 bar		R 1/4"	006600
	change-over-contact <i>Wechselkontakt</i>	10 – 640 bar		R 1/4"	014474
	N/O switch <i>Schließer</i>		5 bar	M10 x 1,5	177273
	N/O switch <i>Schließer</i>		5 bar	M12 x 1,5	018237
	N/O switch <i>Schließer</i>	1 – 10 bar		M12 x 1,5	015431
	N/O switch <i>Schließer</i>		26 bar	M10 x 1	022406
	N/C switch <i>Öffner</i>	1 – 10 bar	5 bar	M12 x 1,5	011540

3.2 PRESSURE SWITCHES / DRUCKSCHALTER

	Usage Verwendung	Pressure Range Druckbereich	Preset Einstelldruck	Thread Gewinde	No. Nr.
	service switch, hydraulic oil filter <i>Wartungsschalter, Hydraulikfilter</i>		2 bar	G 1/2"	124580
	service switch, hydraulic oil filter <i>Wartungsschalter, Hydraulikfilter</i>		2 bar	G 1/2"	028332
	service switch, hydraulic oil filter VR <i>Wartungsschalter, Hydraulikfilter VR</i>		2 bar	G 1/2"	182490
	service switch, hydraulic oil filter VM <i>Wartungsschalter, Hydraulikfilter VM</i>		5 bar	G 1/2"	075990
	service switch, hydraulic oil filter VM <i>Wartungsschalter, Hydraulikfilter VM</i>		5 bar	G 1/2"	128433
	service switch, hydraulic oil filter VD <i>Wartungsschalter, Hydraulikfilter VD</i>		5 bar	G 1/2"	154904
	service switch, hydraulic oil filter VR <i>Wartungsschalter, Hydraulikfilter VR</i>		5 bar	G 1/2"	187154
	service switch, air filter <i>Wartungsschalter, Luftfilter</i>		65 mbar	M10 x 1	043706
	service switch, air filter <i>Wartungsschalter, Luftfilter</i>		50 mbar	M10 x 1	110208
	service switch, air filter <i>Wartungsschalter, Luftfilter</i>		50 mbar	M10 x 1	075947





3.3 LIMIT SWITCHES

ENDSCHALTER

	Description <i>Bezeichnung</i>	No. <i>Nr.</i>		Description <i>Bezeichnung</i>	No. <i>Nr.</i>
	limit switch <i>Endschalter</i> AT4/11-S/I/R316	037466		limit switch <i>Endschalter</i> D-U1 W	001810
	limit switch <i>Endschalter</i> D-A1Z HW	046890		limit switch <i>Endschalter</i> EN-U1 R	024447
	limit switch <i>Endschalter</i> D-A1Z STW	046892		limit switch <i>Endschalter</i> FR501-V9	179094
	limit switch <i>Endschalter</i> D-A1Z W	046891		limit switch <i>Endschalter</i> GC SU1 LIW	038674
	limit switch <i>Endschalter</i> D-SU1 HW	100212		limit switch <i>Endschalter</i> GC SU1 STW	001312
	limit switch <i>Endschalter</i> D-SU1 W	046889		limit switch <i>Endschalter</i> GC-SU1Z KNIW	200022
	limit switch <i>Endschalter</i> D-U1 HW	004293		limit switch <i>Endschalter</i> SN2-U1Z RIW	150291
	limit switch <i>Endschalter</i> D-U1 STW	004895		limit switch <i>Endschalter</i> Ti2-SU1Z RIW	048805

3.4 SOLENOID COILS

MAGNETSPULEN





	Description Bezeichnung	No. Nr.		Description Bezeichnung	No. Nr.
	Ø = 16 mm, L x W (B) = 53 x 36 mm 24 V / 17 W (DT04)	134099		Ø = 22 mm, L x W (B) = 50 x 45 mm 24 V / 31 W (JPT)	174005
	Ø = 18 mm, L x W (B) = 40 x 36 mm 24 V / 30 Ω (DT04)	222594		Ø = 22 mm, L x W (B) = 52 x 45 mm 24 V / 31 W (JPT)	107457
	Ø = 19 mm, L x W (B) = 50 x 37 mm 24 V / 18 W (DT04)	138696		Ø = 31 mm, L x W (B) = 74 x 62 mm 24 V / 42 W (JPT)	107669
	Ø = 19 mm, L x W (B) = 50 x 37 mm 24 V / 20 W (DT04)	216030		Ø = 13 mm, L x W (B) = 34 x 29 mm 24 V / 12 W (DIN 43650)	023102
	Ø = 19 mm, L x W (B) = 50 x 37 mm 27 V / 20 W (DT04)	182510		Ø = 13 mm, L x W (B) = 34 x 29 mm 24 V / 12 W (DIN 43650)	014816
	Ø = 19 mm, L x W (B) = 50 x 37 mm 27 V / 22 W (DT04)	198461		Ø = 13 mm, L x W (B) = 35 x 37 mm 24 V / 18 W (DIN 43650)	135197
	Ø = 12 mm, L x W (B) = 39 x 36 mm 24 V / 20 W (JPT)	172956		Ø = 13 mm, L x W (B) = 41 x 34 mm 24 V / 19 W (DIN 43650)	067144
	Ø = 13 mm, L x W (B) = 40 x 34 mm 24 V / 19 W (JPT)	153938		Ø = 13 mm, L x W (B) = 39 x 36 mm 24 V / 20 W (DIN 43650)	159538
	Ø = 13 mm, L x W (B) = 45 x 33 mm 24 V / 14 W (JPT)	106994		Ø = 13 mm, L x W (B) = 45 x 33 mm 24 V / 14 W (DIN 43650)	079816
	Ø = 16 mm, L x W (B) = 50 x 37 mm 24 V / 23 Ω (JPT)	083156		Ø = 13 mm, L x W (B) = 45 x 34 mm 24 V / 14 W (DIN 43650)	081429
	Ø = 16 mm, L x W (B) = 53 x 36 mm 24 V / 20 W (JPT)	108727		Ø = 16 mm, L x W (B) = 45 x 33 mm 24 V / 17 W (DIN 43650)	023101
	Ø = 16 mm, L x W (B) = 53 x 36 mm 24 V / 27 W (JPT)	154501		Ø = 16 mm, L x W (B) = 53 x 36 mm 24 V / 27 W (DIN 43650)	154460
	Ø = 18 mm, L x W (B) = 40 x 36 mm 24 V / 30 Ω (JPT)	083157		Ø = 16 mm, L x W (B) = 54 x 37 mm 24 V / 20 W (DIN 43650)	081412
	Ø = 19 mm, L x W (B) = 50 x 37 mm 24 V / 20 W (JPT)	108742		Ø = 19 mm, L x W (B) = 51 x 37 mm 24 V / 18 W (DIN 43650)	075379
	Ø = 19 mm, L x W (B) = 50 x 37 mm 27 V / 20 W (JPT)	166195		Ø = 19 mm, L x W (B) = 55 x 40 mm 24 V / 27 W (DIN 43650)	160231

3.4 SOLENOID COILS / MAGNETSPULEN

	Description <i>Bezeichnung</i>	No. <i>Nr.</i>		Description <i>Bezeichnung</i>	No. <i>Nr.</i>
	Ø = 19 mm, L x W (B) = 57 x 46 mm 27 V / 33 W (DIN 43650)	139425		Ø = 22 mm, L x W (B) = 52 x 45 mm 24 V / 31 W (DIN 43650)	081339
	Ø = 22 mm, L x W (B) = 50 x 45 mm 24 V / 31 W (DIN 43650)	156097		Ø = 23 mm, L x W (B) = 50 x 45 mm 24 V / 30 W (DIN 43650)	080218
	Ø = 22 mm, L x W (B) = 50 x 45 mm 24 V / 34 W (DIN 43650)	028828		Ø = 31 mm, L x W (B) = 73 x 62 mm 24 V / 42 W (DIN 43650)	084781









3.5 SENSORS *SENSOREN*

Oil Pressure Sensors / *Öldruckgeber*





	Description <i>Bezeichnung</i>	Usage <i>Verwendung</i>	Pressure Range <i>Druckbereich</i>	No. <i>Nr.</i>
	oil pressure sensor <i>Öldruckgeber</i>	engine oil <i>Motoröl</i>	0 - 5 bar	039647
	oil pressure sensor <i>Öldruckgeber</i>	engine oil <i>Motoröl</i>	0 - 10 bar	110280
	oil pressure sensor, floating <i>Öldruckgeber, massefrei</i>	engine oil, CAT <i>Motoröl, CAT</i>	0 - 10 bar	037769
	oil pressure sensor <i>Öldruckgeber</i>	engine oil <i>Motoröl</i>	0 - 10 bar	096391

3.5 SENSORS / SENSOREN

Inductive Sensors / Induktivsensoren

















	Description <i>Bezeichnung</i>	Function <i>Funktion</i>	Thread <i>Gewinde</i>	No. <i>Nr.</i>
	inductive sensor <i>Induktivsensor</i>	N/O <i>Schließer</i>	M11 x 1	171577
	inductive sensor <i>Induktivsensor</i>	N/C / N/O <i>Öffner / Schließer</i>	M12 x 1,5	054354
	inductive sensor <i>Induktivsensor</i>	N/O <i>Schließer</i>	M18 x 1	040869
	inductive sensor <i>Induktivsensor</i>	N/C <i>Öffner</i>	M18 x 1	040870
	inductive sensor <i>Induktivsensor</i>	N/O <i>Schließer</i>	M18 x 1	160093
	inductive sensor <i>Induktivsensor</i>	N/C / N/O <i>Öffner / Schließer</i>	M18 x 1	174595
	inductive sensor <i>Induktivsensor</i>	N/O <i>Schließer</i>	M30 x 1,5	062261
	inductive sensor <i>Induktivsensor</i>	N/O <i>Schließer</i>		054108
	inductive sensor <i>Induktivsensor</i>	N/C <i>Öffner</i>		054109

Level Switches / Niveauschalter

	Description <i>Bezeichnung</i>	Usage <i>Verwendung</i>	Thread <i>Gewinde</i>	No. <i>Nr.</i>
	level switch <i>Niveauschalter</i>	coolant <i>Kühlwasser</i>	1/4" NPTF	036721
	level switch <i>Niveauschalter</i>	coolant <i>Kühlwasser</i>	1/4" NPTF	141148
	level switch <i>Niveauschalter</i>	coolant <i>Kühlwasser</i>	M14 x 1,5	039346
	level switch <i>Niveauschalter</i>	coolant <i>Kühlwasser</i>	M14 x 1,5	156174
	level switch <i>Niveauschalter</i>	hydraulic oil <i>Hydrauliköl</i>	M18 x 1,5	036401

3.5 SENSORS / *SENSOREN*

Temperature Sensors / *Temperatursensoren*

	Description <i>Bezeichnung</i>	Usage <i>Verwendung</i>	Temperature Range <i>Temperaturbereich</i>	Thread <i>Gewinde</i>	No. <i>Nr.</i>
	temperature sensor <i>Temperatursensor</i>	coolant <i>Kühlwasser</i>	111 °C / max 150 °C	M14 x 1,5	078910
	temperature sensor <i>Temperatursensor</i>	coolant <i>Kühlwasser</i>	0 - 150 °C	M14 x 1,5	098493
	temperature sensor <i>Temperatursensor</i>	coolant <i>Kühlwasser</i>	-40 - 130 °C	3/8" - 18 NPT	110132
	temperature sensor <i>Temperatursensor</i>	coolant <i>Kühlwasser</i>	108 °C / max 120 °C	1/2" - 14 NPTF	110281
	temperature switch <i>Temperaturschalter</i>	coolant <i>Kühlwasser</i>	switch point <i>Schaltpunkt</i> 103 °C		033364
	temperature switch <i>Temperaturschalter</i>	coolant <i>Kühlwasser</i>	switch point <i>Schaltpunkt</i> 110 °C	M14 x 1,5	092603
	temperature sensor <i>Temperatursensor</i>	coolant, hydraulic oil <i>Kühlwasser,</i> <i>Hydrauliköl</i>	-25 - 125 °C	G 1/4"	141970
	temperature sensor <i>Temperatursensor</i>	hydraulic oil <i>Hydrauliköl</i>	0 - 120 °C	M14 x 1,5	037767
	temperature switch <i>Temperaturschalter</i>	hydraulic oil <i>Hydrauliköl</i>	switch point <i>Schaltpunkt</i> 55 °C - 50 °C		017784
	temperature switch <i>Temperaturschalter</i>	hydraulic oil <i>Hydrauliköl</i>	switch point <i>Schaltpunkt</i> 85 °C		018590
	temperature sensor <i>Temperatursensor</i>	intercooler <i>Ladeluft</i>	-40 - 130 °C	3/8" - 18 NPT	110133
	temperature sensor <i>Temperatursensor</i>	exhaust aftertreatment <i>Abgasnachbehandlung</i>	-50 - 150 °C		174433
	temperature sensor <i>Temperatursensor</i>	outdoor temperatur <i>Außentemperatur</i>			155468
	temperature sensor <i>Temperatursensor</i>	air conditioner <i>Klimagerät</i>			138362
	temperature sensor <i>Temperatursensor</i>	air filter <i>Luftfilter Cummins</i>			242401
	temperature transduce <i>Temperaturmess-</i> <i>umformer</i>	ambient temperature <i>Umgebungstemperatur</i>	-50 - 100 °C	G 1/4"	194638

3.6 CONNECTORS DT, DRC, HD

STECKVERBINDER DT, DRC, HD

Connectors DT-Series / Steckverbinder DT-Serie



Connectors consist of housings, contacts, wedge-lock and dust caps.

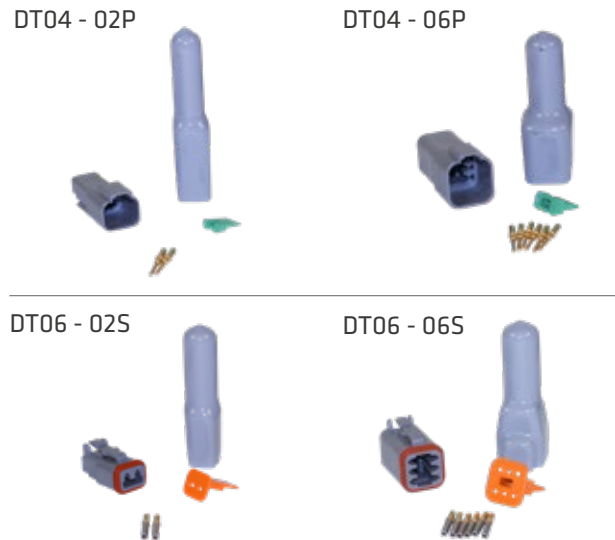

Steckverbinder bestehen aus Gehäusen, Kontakten, Sicherungskeilen und Staubschutzkappen.



Pins / Polzahl	Type / Typ	No. / Nr.
2	DT04 - 02P	157335
3	DT04 - 03P	157337
4	DT04 - 04P	157339
6	DT04 - 06P	157341
8	DT04 - 08P	157343
12	DT04 - 12P	157345
2	DT06 - 02S	157336
3	DT06 - 03S	157338
4	DT06 - 04S	157340
6	DT06 - 06S	157342
8	DT06 - 08S	157344
12	DT06 - 12S	157346

Components DT-Series / Einzelteile DT-Serie

	Pins Polzahl	Plug Stiftleiste	Wedge-lock Verriegelung	Cover Staubschutz
	2	037632	042682	110496
	3	038130	040170	110498
	4	057611	057613	110500
	6	042678	042683	110502
	8	038129	040173	110504
	12	037631	040171	110506
	crimp contact / Crimpkontakt	pin / Stift	1 - 2 mm ²	048750

	Pins Polzahl	Socket Board Buchsenleiste	Wedge-lock Verriegelung	Cover Staubschutz
	2	037636	042680	110497
	3	038132	040169	110499
	4	057610	057612	110501
	6	042679	042681	110503
	8	038131	040174	110505
	12	037635	040172	110507
	crimp contact / Crimpkontakt	socket / Buchse	1 - 2 mm ²	048749

3.6 CONNECTORS DT, DRC, HD / STECKVERBINDER DT, DRC, HD

Connectors DRC-Series / Steckverbinder DRC-Serie

Connectors consist of housings, contacts, dust caps and cable sleeves.

Steckverbinder bestehen aus Gehäusen, Kontakten, Staubschutzkappen und Kabeltüllen.

DRC12 - 24PA



DRC16 - 24SA



Pins / Polzahl	Type / Typ	No. / Nr.
24	DRC12 - 24PA	157347
40	DRC12 - 40PA	157349
70	DRC12 - 70PA	157351
24	DRC16 - 24SA	157348
40	DRC16 - 40SA	157350
70	DRC16 - 70SA	157352

Components DRC-Series / Einzelteile DRC-Serie

	Pins / Polzahl	Plug / Stiftleiste	Cable Sleeve / Kabeltülle	
	24	037630	110418	
	40	037629	039410	
	70	038197	042485	
	crimp contact / Crimpkontakt	pin / Stift	1 - 2 mm ²	048750

	Pins / Polzahl	Socket Board / Buchsenleiste	Cable Sleeve / Kabeltülle	
	24	037634	110418	
	40	038133	039410	
	70	038198	042485	
	crimp contact / Crimpkontakt	socket / Buchse	1 - 2 mm ²	048749







Components HD-Series / Einzelteile HD-Serie

	Pins / Polzahl	Plug / Stiftleiste	Panel Nut / Blendenmutter	
	14	071566	071570	
	19	071567	071571	
	crimp contact / Crimpkontakt	pin / Stift	1 - 2 mm ²	048750
	crimp contact / Crimpkontakt	pin / Stift	2,5 mm ²	073593





	Pins / Polzahl	Socket Board / Buchsenleiste		
	14	071568		
	19	071569		
	crimp contact / Crimpkontakt	socket / Buchse	1 - 2 mm ²	048749
	crimp contact / Crimpkontakt	socket / Buchse	2,5 mm ²	073594

3.6 CONNECTORS DT, DRC, HD / STECKVERBINDER DT, DRC, HD

Crimp Contacts / Crimpkontakte

	Description <i>Bezeichnung</i>	Type <i>Typ</i>	Diameter <i>Querschnitt</i>	No. <i>Nr.</i>
	crimp contact <i>Crimpkontakt</i>	pin <i>Stift</i>	1 - 2 mm ²	048750
	crimp contact <i>Crimpkontakt</i>	socket <i>Buchse</i>	1 - 2 mm ²	048749
	crimp contact <i>Crimpkontakt</i>	pin <i>Stift</i>	2,0 mm ²	037637
	crimp contact <i>Crimpkontakt</i>	socket <i>Buchse</i>	2,0 mm ²	037638
	crimp contact <i>Crimpkontakt</i>	pin <i>Stift</i>	2,5 mm ²	073593
	crimp contact <i>Crimpkontakt</i>	socket <i>Buchse</i>	2,5 mm ²	073594
	dummy plug <i>Blindstopfen</i>			050904

Crimp Tools / Crimpwerkzeuge

	Description <i>Bezeichnung</i>	Color <i>Farbe</i>	Diameter <i>Querschnitt</i>	No. <i>Nr.</i>
	extractor tool <i>Ausziehwerkzeug</i>	red <i>rot</i>	1,0 mm ²	038135
	extractor tool <i>Ausziehwerkzeug</i>	blue <i>blau</i>	1,5 mm ²	040176
	extractor tool <i>Ausziehwerkzeug</i>	yellow <i>gelb</i>	2,5 mm ²	073595
	crimp pliers <i>Crimpzange</i>			059125

3.7 CONNECTORS ILME

STECKVERBINDER ILME

ILME-Connectors (Complete, Screwed Contact)

ILME-Steckverbinder (komplett, Schraubkontakt)

Pins <i>Polzahl</i>	Complete Set* <i>Komplettsatz*</i>	Plug Set* <i>Steckersatz*</i>	Socket Set* <i>Buchsensatz*</i>
6	185638	185637	185634
6	246057	246019	185634
10	185611	185610	185609
10	185618	185617	185614
16	185593	185591	185592
16	185600	185599	185596
24	185568	185571	185569
24	185572	185571	185570
24	185573	185574	185578
24	185582	185581	185578

ILME-Connectors (Complete, Crimp Contact)

ILME-Steckverbinder (komplett, Crimpkontakt)

Pins <i>Polzahl</i>	Complete Set* <i>Komplettsatz*</i>	Plug Set* <i>Steckersatz*</i>	Socket Set* <i>Buchsensatz*</i>
6	206620	206619	185624
6	206622	185619	206621
10	185603	185602	185601
10	185608	185607	185605
16	185583	185584	185585
16	185586	185587	185588
16	206624	206623	185588
16	206626	185584	206625
24	185546	185547	185548
24	185554	185553	185552
24	185555	185556	185557
24	206629	206628	185557
24	206631	185549	206630
64	183145	183144	185543
64	183148	183146	183147
64	183150	183146	183149
64	185539	185540	185543
64	206633	206632	185543
64	206635	183146	206634

*) A complete set consists of a plug set and a socket set. Pictures of the individual components are shown on the following pages.

*) Ein Komplettsatz besteht aus einem Steckersatz und einem Buchsensatz. Die einzelnen Komponenten sind auf den nachfolgenden Seiten abgebildet.

3.7 CONNECTORS ILME / STECKVERBINDER ILME

















ILME-Plugs (Screwed Contacts, Sets and Components)

ILME-Stecker (Schraubkontakte, Sätze und Einzelteile)

Pins Polzahl	Plug Set* Steckersatz*		Plug Stiftleiste		Housing Gehäuse
6	246019		185635		206618
6	185629		185635		185636
6	185630		185635		185633
6	185637		185635		185636
10	185610		185615		185613
10	185617		185615		185616
16	185591		185597		185595
16	185599		185597		185598
24	185571		185579		185577
24	185574		185579		185575
24	185581		185579		185580

3.7 CONNECTORS ILME / STECKVERBINDER ILME

















ILME-Plugs (Crimp Contacts, Sets and Components) ILME-Stecker (Crimpkontakte, Sätze und Einzelteile)

Pins Polzahl	Plug Set* Steckersatz*	Plug Stiftleiste	Housing Gehäuse	Crimp Contacts Crimpkontakt	Diameter Durchmesser			
6	206619		185626		206618		185625	1,5 mm ²
6	185619		185626		185633		185625	1,5 mm ²
6	185627		185626		185636		185625	1,5 mm ²
10	185602		185606		185613		185625	1,5 mm ²
10	185607		185606		185616		185625	1,5 mm ²
16	185584		185589		185595		185625	1,5 mm ²
16	185587		185589		185598		185625	1,5 mm ²
16	206623		185589		206617		185625	1,5 mm ²
24	185547		185558		185577		185625	1,5 mm ²
24	185553		185558		185575		185625	1,5 mm ²
24	185556		185558		185580		185625	1,5 mm ²
24	206628		185558		206616		185625	1,5 mm ²
64	183146		185542		185577		185541	1,5 mm ²
64	183144		185542		185575		185541	1,5 mm ²
64	206632		185542		206616		185541	1,5 mm ²

*) A plug set (crimp contacts) consists of plug, housing and crimp contacts.
*) Ein Steckersatz (Crimpkontakte) besteht aus Stiftleiste, Gehäuse und Crimpkontakten.







































3.7 CONNECTORS ILME / STECKVERBINDER ILME

ILME-Sockets (Screwed Contacts, Sets and Components) ILME-Buchsen (Schraubkontakte, Sätze und Einzelteile)

Pins Polzahl	Socket Set* Buchsensatz*		Socket Board Buchsenleiste		Housing Gehäuse
6	185634		185632		185633
10	185609		185612		185616
10	185614		185612		185613
16	185592		185594		185598
16	185596		185594		185595
24	185570		185576		185580**
24	185569		185576		185575***
24	185578		185576		185577

3.7 CONNECTORS ILME / STECKVERBINDER ILME

ILME-Sockets (Crimp Contacts, Sets and Components) ILME-Buchsen (Crimpkontakte, Sätze und Einzelteile)

Pins Polzahl	Socket Set* Buchsensatz*	Socket Board Buchsenleiste	Housing Gehäuse	Crimp Contacts Crimpkontakt	Diameter Durchmesser
6	185624	 185622	 185633	 185623	1,5 mm ²
6	206621	 185622	 206618	 185623	1,5 mm ²
10	185601	 185604	 185616	 185623	1,5 mm ²
10	185605	 185604	 185613	 185623	1,5 mm ²
16	185585	 185590	 185598	 185623	1,5 mm ²
16	185588	 185590	 185595	 185623	1,5 mm ²
16	206625	 185590	 206617	 185623	1,5 mm ²
24	185548	 185559	 185575	 185623	1,5 mm ²
24	185557	 185559	 185577	 185623	1,5 mm ²
24	206630	 185559	 206616	 185623	1,5 mm ²
64	185543	 185545	 185577	 185544	1,5 mm ²
64	183149	 185545	 185575	 185544	1,5 mm ²
64	206634	 185545	 206616	 185544	1,5 mm ²

*) A socket set (crimp contacts) consists of socket board, housing and crimp contacts.
*) Ein Buchsensatz (Crimpkontakte) besteht aus Buchsenleiste, Gehäuse und Crimpkontakten.

3.8 CONNECTORS HARTING

STECKVERBINDER HARTING



























Harting-Plugs (Screwed Contacts, Sets and Components)

Harting-Stecker (Schraubkontakte, Sätze und Einzelteile)

Pins <i>Polzahl</i>	Plug Set* <i>Steckersatz*</i>	Plug <i>Stiftleiste</i>	Housing <i>Gehäuse</i>
6	159862	 038126	 037622
6	159864	 038126	 038127
16	159868	 078364	 079077
16	159866	 078364	 079083
24	159874	 120896	 058396**
24	159870	 120896	 058398***
24	159872	 120896	 120898

3.8 CONNECTORS HARTING / STECKVERBINDER HARTING













Harting-Plugs (Crimp Contacts, Sets and Components) Harting-Stecker (Crimpkontakte, Sätze und Einzelteile)

Pins Polzahl	Plug Set* Steckersatz*	Plug Stiftleiste	Housing Gehäuse	Crimp Contacts Crimpkontakt	Diameter Durchmesser
24	159878				1,0 mm ²
24	159876				1,0 mm ²
24	159882				1,5 mm ²
24	159880				1,5 mm ²
64	159886				1,0 mm ²
64	159884				1,0 mm ²
64	159890				1,5 mm ²
64	159888				1,5 mm ²
64	227900				2,5 mm ²

*) A plug set (crimp contacts) consists of plug, housing and crimp contacts.
*) Ein Steckersatz (Crimpkontakte) besteht aus Stiftleiste, Gehäuse und Crimpkontakten.































3.8 CONNECTORS HARTING / STECKVERBINDER HARTING

Harting-Sockets (Screwed Contacts, Sets and Components) Harting-Buchsen (Schraubkontakte, Sätze und Einzelteile)

Pins <i>Polzahl</i>	Socket Set* <i>Buchsensatz*</i>		Socket Board <i>Buchsenleiste</i>		Housing <i>Gehäuse</i>
6	159863		037624		038127
6	159865		037624		037622
16	159869		078363		079083
16	159867		078363		079077
24	159871		120897		120898
24	159875		120897		058396**
24	159873		120897		058398***

3.8 CONNECTORS HARTING / STECKVERBINDER HARTING

Harting-Sockets (Crimp Contacts, Sets and Components) Harting-Buchsen (Crimpkontakte, Sätze und Einzelteile)

Pins Polzahl	Socket Set* Buchsensatz*		Socket Board Buchsenleiste		Housing Gehäuse		Crimp Contacts Crimpkontakt	Diameter Durchmesser
24	159883		068040		058398		068046	1,5 mm ²
24	159881		068040		120898		068046	1,5 mm ²
24	159879		068040		058398		068045	1,0 mm ²
24	159877		068040		120898		068045	1,0 mm ²
64	159891		058393		058938		068046	1,5 mm ²
64	159889		058393		120898		068046	1,5 mm ²
64	159885		058393		120898		068045	1,0 mm ²
64	159887		058393		058398		068045	1,0 mm ²
64	227901		058393		058398		071721	2,5 mm ²

*) A socket set (crimp contacts) consists of socket board, housing and crimp contacts.

*) Ein Buchsensatz (Crimpkontakte) besteht aus Buchsenleiste, Gehäuse und Crimpkontakten.

3.9 ADAPTER CABLES

ADAPTERKABEL

Adapter Cables (DT04 - M12) / Adapterkabel (DT04 - M12)



Length Länge	No. Nr.
1 m	183991
2 m	183992
3 m	183993

Adapter Cables (JPT - M12) / Adapterkabel (JPT - M12)



Length Länge	No. Nr.
1 m	121334
2 m	118729

Adapter Cables (DIN 43650 - M12) / Adapterkabel (DIN 43650 - M12)



Pins Polzahl	Length Länge	No. Nr.
3	1 m	050840
3	2 m	050841
5	1 m	050842
5	2 m	050843

Adapter Cables (DIN 43650 - JPT) / Adapterkabel (DIN 43650 - JPT)



Length Länge	No. Nr.
25 cm	110084

3.10 VALVE CONNECTORS

VENTILSTECKER

	Description <i>Bezeichnung</i>	Notes <i>Bemerkung</i>	Type <i>Typ</i>	Specification <i>Spezifikation</i>	No. <i>Nr.</i>
	repair kit <i>Reparatursatz</i>	valve connector <i>Ventilstecker</i>	DT04 / JPT	2-pole, 0,6 m <i>2-polig, 0,6 m</i>	110593
	valve connector <i>Ventilstecker</i>	with cable <i>mit Kabel</i>	DT04 / JPT	2-pole, 0,6 m <i>2-polig, 0,6 m</i>	217187
	valve connector <i>Ventilstecker</i>	with LED, cable and connector <i>mit LED, Kabel und Stecker</i>	DT04 / JPT	2-pole, 0,6 m <i>2-polig, 0,6 m</i>	150916
	valve connector <i>Ventilstecker</i>	with cable <i>mit Kabel</i>	JPT / CDT	2-pole, 0,6 m <i>2-polig, 0,6 m</i>	217188
	valve connector <i>Ventilstecker</i>	with cable <i>mit Kabel</i>	JPT	2-pole, 0,6 m <i>2-polig, 0,6 m</i>	110299
	valve connector <i>Ventilstecker</i>	with cable <i>mit Kabel</i>	JPT	2-pole, 10 m <i>2-polig, 10 m</i>	151087
	valve connector <i>Ventilstecker</i>	with LED <i>mit LED</i>	DIN 43650	3-pole <i>3-polig</i>	022081
	valve connector <i>Ventilstecker</i>	with LED and Z-diode <i>mit LED und Z-Diode</i>	DIN 43650	3-pole <i>3-polig</i>	037691
	valve connector <i>Ventilstecker</i>	with LED <i>mit LED</i>	DIN 43650	4-pole <i>4-polig</i>	068608
	valve connector <i>Ventilstecker</i>	with LED and cable <i>mit LED und Kabel</i>	DIN 43650	3-pole, 5 m <i>3-polig, 5 m</i>	037687
	valve connector <i>Ventilstecker</i>	with LED and cable <i>mit LED und Kabel</i>	DIN 43650	3-pole, 10 m <i>3-polig, 10 m</i>	037688
	valve connector <i>Ventilstecker</i>	with LED and cable <i>mit LED und Kabel</i>	DIN 43650	5-pole, 5 m <i>5-polig, 5 m</i>	037689
	valve connector <i>Ventilstecker</i>	with LED and cable <i>mit LED und Kabel</i>	DIN 43650	5-pole, 10 m <i>5-polig, 10 m</i>	037690
	valve connector <i>Ventilstecker</i>	with cable <i>mit Kabel</i>	DT06	2-pole, 0,6 m <i>2-polig, 0,6 m</i>	198921
	valve connector <i>Ventilstecker</i>	with cable <i>mit Kabel</i>	DT06	2-pole, 2 m <i>2-polig, 2 m</i>	198922
	valve connector <i>Ventilstecker</i>	with cable <i>mit Kabel</i>	DT06	2-pole, 10 m <i>2-polig, 10 m</i>	194416

3.11 ELECTRIC BOXES GREEN LINE ELEKTRIK-KOFFER GREEN LINE



These packages of electrical spare parts include up to 80 different electrical components used in SENNEBOGEN material handling machines. The content comprises of all the relevant electrical components and a multimeter, which means that these boxes include the basic equipment for repairing machinery electrics. Detailed summaries are listed in the appendix. Similar to picture.

Diese Elektrik-Koffer beinhalten bis zu 80 verschiedene Elektrikkomponenten für den Einsatz in SENNEBOGEN Materialumschlagmaschinen. Der Inhalt umfasst alle relevanten Elektrikkomponenten und ein Multimeter. Detaillierte Inhaltsangaben haben wir für Sie im Anhang aufbereitet. Abbildung ähnlich.

Description Bezeichnung	Usage Verwendung	No. Nr.
electric box Elektrik-Koffer	Green Line E-series Green Line E-Serie	169166
electric box Elektrik-Koffer	Green Line D-series Green Line D-Serie	115489
electric box Elektrik-Koffer	Green Line C-series CAT Green Line C-Serie CAT	114816
electric box Elektrik-Koffer	Green Line C-series DEUTZ Green Line C-Serie DEUTZ	159707
electric box Elektrik-Koffer	Green Line A/B-series Green Line A/B-Serie	039333

Design updated
Design aktualisiert

Design updated
Design aktualisiert

3.12 ELECTRIC BOX CRANE LINE ELEKTRIK-KOFFER CRANE LINE



Description Bezeichnung	No. Nr.
This package of electrical spare parts includes various electrical components used in SENNEBOGEN cranes. The content comprises of all the relevant electrical components and a multimeter, which means that these Boxes include the basic equipment for repairing machinery electrics. Detailed summaries are listed in the appendix. <i>Dieser Elektrik-Koffer beinhaltet verschiedene Elektrikkomponenten für den Einsatz in SENNEBOGEN Krane. Der Inhalt umfasst alle relevanten Elektrikkomponenten und ein Multimeter. Somit erhalten Sie mit diesem Koffer die Grundausstattung für Reparaturbedarfe an Maschinenelektrik. Detaillierte Inhaltsangaben haben wir für Sie im Anhang aufbereitet.</i>	095390

5%
Price Advantage
Preisvorteil

Design updated
Design aktualisiert

3.13 RELAY KIT TELESCOPIC CRANES

RELAIS-KIT TELEKRANE



Description
Bezeichnung

No.
Nr.

This relay kit includes more than 40 articles from 19 different relays and electrical components used in SENNEBOGEN telescopic cranes. The content comprises of all the relevant relays. Therefore with this kit you will receive the basic replacement relays required for telescopic cranes. Detailed summaries are listed in the appendix.

168716

Dieses Relais-Kit beinhaltet über 40 Artikel aus 19 verschiedenen Relais- und Elektrikkomponenten für den Einsatz in SENNEBOGEN Telekrane. Der Inhalt umfasst alle relevanten Relais. Somit erhalten Sie mit diesem Koffer die Grundausrüstung für Ersatzbedarfe an Relais für Telekrane. Detaillierte Inhaltsangaben haben wir für Sie im Anhang aufbereitet.

Design updated
Design aktualisiert

3.14 CONNECTOR BOX

STECKVERBINDER-KOFFER



Description
Bezeichnung

No.
Nr.

This package of electrical spare parts includes more than 60 articles from 32 different plugs and connectors used in SENNEBOGEN machines. Apart from small parts like contact pins and sockets this box also contains repair tools such as extractor tools, which form the basic equipment for repairing plugs and plug connectors in SENNEBOGEN machines. Detailed summaries are listed in the appendix.

168667

Dieser Elektrik-Koffer beinhaltet mehr als 60 Artikel aus 32 verschiedenen Steckern und Steckverbindern für den Einsatz in SENNEBOGEN-Maschinen. Neben Kleinteilen wie Kontaktstiften und -buchsen enthält dieser Koffer auch Reparaturwerkzeuge wie z. B. Ausdrücker. Somit erhalten Sie die Grundausrüstung für Reparaturbedarfe an Steckern- und Steckverbindern in SENNEBOGEN-Maschinen. Detaillierte Inhaltsangaben haben wir für Sie im Anhang aufbereitet.

Design updated
Design aktualisiert

3.15 ELECTRIC MEASURING BOX ELEKTRIK-MESSKOFFER



Description Bezeichnung

No.
Nr.

This measuring box offers you a variety of systematic measuring options for any required application. Using the measuring adapter, current or voltage can be measured quickly and easily in all available connections typical in SENNEBOGEN machines.

Dieser Messkoffer bietet Messleistung nach Wunsch und Leistungsvielfalt mit System. Mit Verwendung des Messadapters kann Strom oder Spannung schnell und unkompliziert an allen systemtypischen Anschlüssen gemessen werden.

Functions

- voltage measurements up to 48 volt
- current measurements up to 5 ampere
- 5 meter extension

Funktionen

- Spannungsmessbereich bis 48 Volt
- Strommessbereich bis 5 Ampere
- 5 Meter Verlängerung

138598

3.16 ELECTRIC MEASURING BOX 400 V ELEKTRIK-MESSKOFFER 400 V



Description Bezeichnung

No.
Nr.

This measurement kit contains the basic equipment for analysis work on electrical systems up to 400 V in SENNEBOGEN machines. Recommended by SENNEBOGEN service technicians.

Dieser Messkoffer beinhaltet die Grundausstattung für Analysearbeiten an elektrischen Systemen bis 400 V in SENNEBOGEN Maschinen. Von SENNEBOGEN Servicetechnikern empfohlen.

Content / Inhalt

- 1 x assortment of pliers / Zangensortiment
- 1 x screw driver set / Schraubenziehersatz
- 1 x phase sequence indicator / Drehfeldrichtungsanzeige
- 1 x non-contact voltage tester / Berührungsloser Spannungsmesser
- 1 x non-contact magnetic field tester / Berührungsloser Magnetfeldtester
- 1 x multimeter / Multimeter
- 1 x ampere pliers / Amperezange
- 1 x two-pole voltage tester / 2-poliger Spannungsprüfer

187111

4.1 STARTER MOTORS

ANLASSER



Starter Motors for SENNEBOGEN machines
Anlasser für SENNEBOGEN-Maschinen

- 100 % OEM quality
- powerful
- reliable
- 100 % OEM Qualität
- kraftvoll
- zuverlässig

Model Modell	Engine Motor	Emission Standard	Specification Spezifikation	No. Nr.
718E / 723E	Cummins QSB4.5-C160	Tier 4f / IV	24 V / 4,8 kW	191556
730E	Cummins QSB6.7-C225	Tier 4f / IV	24 V / 7,8 kW	180743
735E	Cummins QSL9-C300	Tier 4f / IV	25 V / 7,8 kW	158326
817E	FPT NEF 45	Tier 4f / IV	24 V / 4 kW	206189
818D / 821C	Cummins QSB4.5-C130	Tier 3 / IIIa	24 V / 3,7 kW	147756
818E / 821E	Cummins QSB4.5-C131	Tier 4f / IV		
821E	Cummins QSB4.5-C140		24 V / 4,8 kW	191556
825D	Cummins QSB6.7-C173	Tier 3 / IIIa		
825E	Cummins QSB6.7-C174	Tier 4f / IV	24 V / 7,8 kW	180743
830D	Cummins QSB6.7-C203	Tier 3 / IIIa	24 V / 4,8 kW	191556
830E	Cummins QSB6.7-C220	Tier 4i / IIIb	24 V / 7,8 kW	180743
830E	Cummins QSB6.7-C225	Tier 4f / IV	24 V / 4,8 kW	191556
835D	Cummins QSB6.7-C260	Tier 3 / IIIa	24 V / 3,7 kW	147756
840D	Cummins QSB6.7-C261	Tier 3 / IIIa	24 V / 4,8 kW	191556
835E / 840E	Cummins QSL9-C300	Tier 4f / IV	24 V / 7,8 kW	158326
850D / 860D	Cummins QSM11-C360	Tier 3 / IIIa	24 V / 7,2 kW	168724
870E	Cummins QSG12-C350	Tier 4f / IV	24 V / 7,5 kW	201601
875E	Cummins QSX15-C525	Tier 4i / IIIb	24 V / 9,0 kW	147757
613E	FPT NEF 45	Tier 4f / IV	24 V / 4 kW	206189
643E	Cummins QSB4.5-C160	Tier 3 / IIIa	24 V / 4,8 kW	191556
643E / 653E	Cummins QSB4.5-C173	Tier 4f / IV		
673E / 6113E	Cummins QSB6.7-C220	Tier 3 / IIIa		
673E / 6113E	Cummins QSB6.7-C225	Tier 4f / IV	24 V / 7,8 kW	180743
1100E	Cummins QSB6.7-C220			

4.2 ALTERNATORS

LICHTMASCHINEN



Alternators for SENNEBOGEN machines
Lichtmaschinen für SENNEBOGEN-Maschinen

- 100 % OEM quality
- powerful
- reliable
- 100 % OEM Qualität
- kraftvoll
- zuverlässig

Model Modell	Engine Motor	Emission Standard	Specification Spezifikation	No. Nr.
718E / 723E	Cummins QSB4.5-C160	Tier 4f / IV	24 V / 120 A	189993
730E	Cummins QSB6.7-C225	Tier 4f / IV	24 V / 125 A	191555
735E	Cummins QSL9-C300	Tier 4f / IV	24 V / 120 A	189993
817E	FPT NEF 45	Tier 4f / IV	24 V / 90 A	206164
818D / 821C	Cummins QSB4.5-C130	Tier 3 / IIIa	24 V / 90 A	250670
818E / 821E	Cummins QSB4.5-C130	Tier 4f / IV	24 V / 120 A	189993
821E	Cummins QSB4.5-C140			
825D	Cummins QSB6.7-C173	Tier 3 / IIIa	24 V / 90 A	250670
825E	Cummins QSB6.7-C173	Tier 4f / IV	24 V / 120 A	189993
830D	Cummins QSB6.7-C203	Tier 3 / IIIa	24 V / 90 A	250670
830E	Cummins QSB6.7-C220	Tier 4i / IIIb	24 V / 125 A	191555
830E	Cummins QSB6.7-C225	Tier 4f / IV	24 V / 120 A	189993
835D	Cummins QSB6.7-C260	Tier 3 / IIIa	24 V / 90 A	250670
840D				
835E / 840E	Cummins QSL9-C300	Tier 4f / IV	24 V / 120 A	189993
850D / 860D	Cummins QSM11-C360	Tier 3 / IIIa	24 V / 100 A	147751
870E	Cummins QSM11-C360	Tier 3 / IIIa	24 V / 120 A	189993
870E	Cummins QSG12-C350	Tier 4f / IV		
875E	Cummins QSX15-C525	Tier 4i / IIIb	24 V / 100 A	189992
613E	FPT NEF 45	Tier 4f / IV	24 V / 90 A	206164
643E	Cummins QSB4.5-C160	Tier 3 / IIIa	24 V / 90 A	250670
643E / 653E	Cummins QSB4.5-C173	Tier 4f / IV		
643E / 653E	Cummins QSB4.5-C173		24 V / 120 A	189993
673E / 6113E	Cummins QSB6.7-C220	Tier 3 / IIIa		
1100E	Cummins QSB6.7-C220	Tier 4f / IV		

4.3 FUEL INJECTORS EINSPRITZDÜSEN



Injectors for SENNEBOGEN machines
with Diesel Engines

*Einspritzdüsen für SENNEBOGEN-Maschinen
mit Diesel-Motoren*

- 100 % OEM quality
- 100 % OEM Qualität

	Engine Motor	Qty. Anz.	No. Nr.
Cummins	QSB4.5 CM850	4	198092
	QSB4.5 CM2250 EC	4	191582
	QSB6.7 CM850	6	198092
	QSB6.7 CM2250	6	191582
	QSB6.7 CM2350 B105	6	198096
	QSL9 CM2250	6	191581
	QSL9 CM2350 L102	6	198093
	QSM11 CM570	6	198095
	QSX15 CM2250 ECF	6	198094
	QSG12 C350	6	232324
Caterpillar	CAT C7	6	198013
	CAT C9	6	198014
	CAT C11	6	198015
	CAT C15	6	198016
Deutz	TCD2012 L04	4	
	TCD2012 L04 2V	4	103373
	TCD2012 L06 2V	6	
	TCD2013 L04 2V	4	
	TCD2013 L06 2V	6	160076
FPT	FPT NEF 45	4	206190

4.4 VALVE COVER GASKETS

VENTILDECKELDICHUNGEN

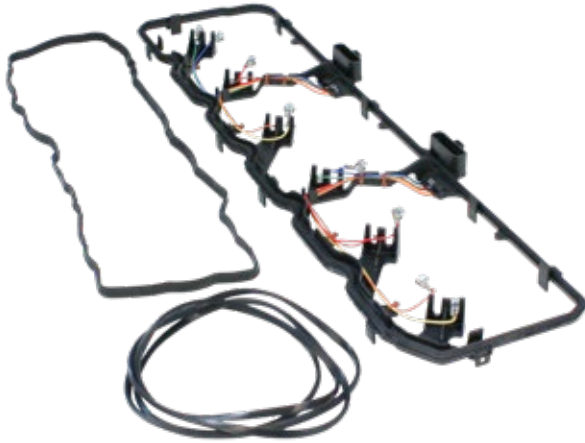

Valve Cover Gaskets for SENNEBOGEN machines with Diesel Engines
 Ventildeckeldichtungen für SENNEBOGEN-Maschinen mit Diesel-Motoren

- 100 % OEM quality
- 100 % OEM Qualität

	Engine Motor	Qty. Anz.	No. Nr.
Cummins	QSB4.5 CM850	1	148255
	QSB4.5 CM2250 EC	1	
	QSB6.7 CM850	1	107130
	QSB6.7 CM2250	1	169481
	QSB6.7 CM2350 B105	1	
	QSL9 CM2250	1	158320
	QSL9 CM2350 L102	1	
	QSM11 CM570	1	159151
	QSX15 CM2250 ECF	1	135266
	QSG12 C350	1	205233
Caterpillar	CAT C7	1	127256
	CAT C9	1	164050
	CAT C11	1	198007
	CAT C15	3	148308
Deutz	TCD2012 L04	1	103370
	TCD2012 L04 2V	1	
	TCD2012 L06 2V	1	105783
	TCD2013 L04 2V	1	115109
	TCD2013 L06 2V	1	125947
FPT	FPT NEF 45	1	206177

4.5 WATER PUMPS AND THERMOSTATS

WASSERPUMPEN UND THERMOSTATE



Water Pumps and Thermostats for
SENNEBOGEN machines with Diesel Engines
*Wasserpumpen und Thermostate für
SENNEBOGEN-Maschinen mit Diesel-Motoren*

- 100 % OEM quality
- durable
- reliable
- 100 % OEM Qualität
- langlebig
- zuverlässig

	Engine Motor	Water Pump Wasserpumpe	Thermostat Thermostat	
Cummins	QSB4.5 CM850			
	QSB4.5 CM2250 EC	191562	191569	
	QSB6.7 CM850			
	QSB6.7 CM2250	191560	191568	
	QSB6.7 CM2350 B105	189990	191569	
	QSL9 CM2250			
	QSL9 CM2350 L102	191561	158325	
	QSM11 CM570	189991	198098	
	QSX15 CM2250 ECF	194685		
Cummins	QSG12 C350	201603	201604 201605	
	Caterpillar	CAT C7		198008 (2x)
		CAT C9	198010	
CAT C11		198011	198009	
CAT C15		198012	198009 (2x)	
Deutz	TCD2012 L04	198020		
	TCD2012 L04 2V		198018	
	TCD2012 L06 2V	179317		
	TCD2013 L04 2V			
	TCD2013 L06 2V	198019	198017	
FPT	FPT NEF 45	206174	206185	

4.6 TURBO CHARGERS

TURBOLADER



Turbo Chargers for SENNEBOGEN machines with Cummins Engines
 Turbolader für SENNEBOGEN-Maschinen mit Cummins-Motoren

- 100 % OEM quality
- powerful
- reliable
- 100 % OEM Qualität
- kraftvoll
- zuverlässig

Due to the high diversity of variants we offer turbo chargers on request. Please always provide machine and engine number.

Aufgrund der hohen Variantenvielfalt erhalten Sie Turbolader bei uns auf Anfrage. Bitte teilen Sie uns dazu stets Maschinen- und Motor-nummer mit.

5.1 AC COMPRESSORS

KLIMAKOMPRESSOREN

Description
 Bezeichnung

No.
 Nr.



AC Compressor
 Klimakompressor

033120

V-belt pulley type A
 Keilriemenscheibe Typ A



AC Compressor
 Klimakompressor



113345

V-belt pulley type PV
 Keilriemenscheibe Typ PV



5.2 SPARE PARTS

ERSATZTEILE

Condensers / Kondensatoren



	Description <i>Bezeichnung</i>	Length <i>Länge</i>	Width <i>Breite</i>	Height <i>Höhe</i>	No. <i>Nr.</i>
	condenser, with fan <i>Kondensator, mit Lüfter</i>	505 mm	365 mm	110 mm	037267
	condenser <i>Kondensator</i>	510 mm	434 mm	47 mm	067806
	condenser <i>Kondensator</i>	610 mm	434 mm	47 mm	091607
	condenser, with collector <i>Kondensator, mit Sammlertrockner</i>	625 mm	440 mm	49 mm	100253

Collectors / Kältemittelsammler





	Description <i>Bezeichnung</i>	Notes <i>Bemerkung</i>	No. <i>Nr.</i>
	collector <i>Kältemittelsammler</i>	suction gas accumulator <i>Saug-Gas-Akkumulator</i>	155306
	collector drier <i>Sammlertrockner</i>	with pressure switch <i>mit Druckschalter</i>	037268
	collector drier <i>Sammlertrockner</i>	with pressure switch <i>mit Druckschalter</i>	105707

5.2 SPARE PARTS / ERSATZTEILE

Expansion Valves / Expansionsventile



	Description <i>Bezeichnung</i>	Length <i>Länge</i>	Width <i>Breite</i>	Height <i>Höhe</i>	No. <i>Nr.</i>
	expansion valve <i>Expansionsventil</i>	54 mm	45 mm	25 mm	046326
	expansion valve <i>Expansionsventil</i>	58 mm	33 mm	25 mm	046782

Evaporators / Verdampfer



	Description <i>Bezeichnung</i>	Length <i>Länge</i>	Width <i>Breite</i>	Height <i>Höhe</i>	No. <i>Nr.</i>
	evaporator <i>Verdampfer</i>	310 mm	200 mm	115 mm	037266
	evaporator <i>Verdampfer</i>	365 mm	170 mm	100 mm	046786
	evaporator <i>Verdampfer</i>	382 mm	287 mm	53 mm	231555
	evaporator <i>Verdampfer</i>	385 mm	195 mm	95 mm	127435

5.2 SPARE PARTS / ERSATZTEILE

Thermostats / Thermostate







	Description <i>Bezeichnung</i>	Usage <i>Verwendung</i>	Type <i>Typ</i>	No. <i>Nr.</i>
	thermostat <i>Thermostat</i>	air conditioner <i>Klimagerät</i>	preset <i>fest eingestellt</i>	050980
	thermostat <i>Thermostat</i>	air conditioner <i>Klimagerät</i>	preset, electr. <i>fest eingestellt, elektronisch</i>	107200

Centrifugal Fans / Gebläsemotoren

	Description <i>Bezeichnung</i>	Usage <i>Verwendung</i>	No. <i>Nr.</i>
	centrifugal fan <i>Radialgebläse</i>		147182
	twin centrifugal fan <i>Doppelradialgebläse</i>		147180
	twin centrifugal fan <i>Doppelradialgebläse</i>		150493
	resistor <i>Widerstand</i>	centrifugal fan 174182, 174180 and 150493 <i>Gebläsemotor 174182, 174180 und 150493</i>	138357
	resistor <i>Widerstand</i>	centrifugal fan 107203 and 037252 <i>Gebläsemotor 107203 und 037252</i>	032492
	centrifugal fan with oval resistor <i>Radialgebläse mit Ovalwiderstand</i>		231553



5.2 SPARE PARTS / ERSATZTEILE

Heat Exchangers / Wärmetauscher







	Description <i>Bezeichnung</i>	Usage <i>Verwendung</i>	L x W x H <i>L x B x H</i>	No. <i>Nr.</i>
	heat exchanger <i>Wärmetauscher</i>	F2000 / F2002 Kabine	335 mm x 195 mm x 45 mm	037253
	heat exchanger <i>Wärmetauscher</i>	305, 608, 613, TS9	345 mm x 165 mm x 45 mm	046789
	heat exchanger <i>Wärmetauscher</i>	310, 620, 718, 818, MultiCab 1	375 mm x 195 mm x 45 mm	127437
	heat exchanger <i>Wärmetauscher</i>	MultiCab 2	377 mm x 195 mm x 45 mm	228901
	heat exchanger, with evaporator <i>Wärmetauscher, mit Verdampfer</i>	MaxCab 1	385 mm x 135 mm x 290 mm	107198
	heat exchanger <i>Wärmetauscher</i>	MaxCab 2	382 mm x 287 mm x 45 mm	231554

5.2 SPARE PARTS / ERSATZTEILE

Geared Motors / Getriebemotoren

	Description <i>Bezeichnung</i>	Usage <i>Verwendung</i>	Specification <i>Spezifikation</i>	No. <i>Nr.</i>
	geared motor <i>Getriebemotor</i>	heater valve <i>Heizungsventil</i>	24 V, 5-pole <i>24 V, 5-polig</i>	114084
	geared motor <i>Getriebemotor</i>	circulating air <i>Umluftsteuerung</i>	24 V, 2-pole, with catch <i>24 V, 2-polig, mit Mitnehmer</i>	107199
	geared motor <i>Getriebemotor</i>	circulating air <i>Umluftsteuerung</i>	24 V, 2-pole <i>24 V, 2-polig</i>	138360

Heater Valves / Heizungsventile

	Description <i>Bezeichnung</i>	Type <i>Typ</i>	No. <i>Nr.</i>
	heater valve <i>Heizungsventil</i>	manual <i>manuell</i>	037254
	heater valve <i>Heizungsventil</i>	with actuator <i>mit Stellmotor</i>	107197
	heater valve <i>Heizungsventil</i>	with actuator <i>mit Stellmotor</i>	223721
	heater valve <i>Heizungsventil</i>	with actuator and limit switch <i>mit Stellmotor und Endschalter</i>	113346
	water valve 4/2-way <i>Wasserventil 4/2-Wege</i>	with actuator <i>mit Stellmotor</i>	202195
	water valve 4/2-way <i>Wasserventil 4/2-Wege</i>	with actuator <i>mit Stellmotor</i>	240215

6.1

REMAN PROGRAM AT-PROGRAMM

Machine availability and sustainability are the basic idea of a SENNEBOGEN remanufactured part.

Remanufactured parts are professionally reconditioned, rebuilt genuine parts. The following rule applies: defective machine components go through an extensive and systematic renewal process during which they are completely disassembled; cleaned and defective items are replaced. After being reassembled they are checked and tested under the same strict procedures as new parts.

95 % of all parts which cannot be reconditioned will be recycled. In our webshop we offer available remanufactured parts as an alternative to each item entered. It is therefore possible to take advantage of our reman program at anytime.

Maschinenverfügbarkeit und Nachhaltigkeit sind die Grundgedanken eines SENNEBOGEN-Austauschteils.

Austauschteile sind professionell wieder aufbereitete, generalüberholte Originalteile. Dabei gilt folgendes Prinzip: Defekte Maschinenkomponenten werden einem umfassenden und systematischen Erneuerungsprozess zugeführt, in dessen Verlauf sie komplett zerlegt, gereinigt, defekte Einzelteile ausgetauscht, anschließend wieder zusammengebaut und schließlich auf einwandfreie Funktion hin überprüft werden. Dabei unterliegt jedes Aus-

tauschteil den gleichen Qualitätsrichtlinien wie ein Original SENNEBOGEN-Teil.

Alle Teile, die nicht unmittelbar aufbereitet werden können, werden zu 95 Prozent recycelt. Vorläufige Austauschteile bieten wir Ihnen in unserem Webshop alternativ zu jeder erfassten Position an. So ist es Ihnen jederzeit möglich, die Vorteile aus unserem AT-Programm zu nutzen.

hydraulic cylinders
Hydraulikzylinder



rotary transmissions
Drehdurchführungen



slewing gears
Drehgetriebe





6.1 REMAN PROGRAM / AT-PROGRAMM

Your Benefits

» Machine Availability

- quick supply of remanufactured parts
- availability of parts for at least 10 years after end of series production

» Cost Savings

- save up to 40 % on SENNEBOGEN remanufactured parts
- repair costs corresponding to current machine value

» Quality

- same quality standard as new parts
- renewal process is subject to strict SENNEBOGEN guidelines

» Environmental Protection

- professional and resource-saving reconditioning
- helps to avoid cost- and energy-intensive process steps during production

Ihre Vorteile

» Maschinenverfügbarkeit

- rasche Bereitstellung wiederaufbereiteter Teile
- Teilverfügbarkeit über 10 Jahre nach Serienauslauf

» Kosteneinsparung

- bis zu 40 % günstiger als SENNEBOGEN-Neuteile
- Reparaturkosten entsprechend altersgemäßem Maschinenzeitwert

» Qualität

- gleiche Qualitätsstandards wie Neuteile
- Aufbereitungsprozess unterliegt strengen SENNEBOGEN-Richtlinien

» Umweltschutz

- fachgerechte und ressourcenschonende Wiederaufbereitung
- Vermeidung kosten- und energieintensiver Bearbeitungsschritte bei der Neuproduktion

generators
Generatoren

control blocks
Steuerblöcke

rotors
Drehköpfe

bottom hook blocks
Unterflaschen



6.2 REMAN PROGRAM OVERVIEW

AT-PROGRAMM ÜBERSICHT

		Auxiliary Control Units Vorsteuergeräte	Axle Distribution Gearboxes Achsverteilergetriebe	Axles Achsen	Control Blocks Steuerblöcke	Crawler Gearboxes Raupenfahrgetriebe	Diesel Particulate Filters Dieselpartikelfilter	Displays Anzeigegeräte
	Material Handler Umschlagmaschine							
	Mobile Mobil	✓	✓	✓	✓		✓	✓
	Crawler Raupe	✓			✓	✓	✓	✓
	Stationary Stationär	✓			✓		✓	✓
	Rail Schiene	✓			✓		✓	✓
	Truck / Ship-Mounted Aufbau	✓			✓		✓	✓
	Multihandler/-loader Multihandler/-loader							
	Multihandler Multihandler			✓	✓			
	XL-Multihandler XL-Multihandler			✓	✓			
	Multiloader Multiloader				✓			
	Heavy Duty Cycle Crane Seilbagger							
	Mobile Mobil	✓	✓	✓	✓			✓
	Crawler Raupe	✓			✓	✓	✓	✓
	Cranes Krane							
	Crawler Cranes Raupenkrane				✓	✓	✓	✓
	Port Mobile Hafen Mobil			✓	✓		✓	✓
	Port Crawler Hafen Raupe				✓	✓	✓	✓
	Telescopic Cranes Teleskopkrane							
	Mobile Mobil	✓	✓	✓	✓			✓
	Crawler Raupe	✓			✓	✓		✓
	HPC 40 HPC 40				✓			



6.2 REMAN PROGRAM OVERVIEW / AT-PROGRAMM ÜBERSICHT

Distribution Gearboxes <i>Verteilergetriebe</i>	Electric Motors <i>Elektromotoren</i>	Generators <i>Generatoren</i>	Hydraulic Cylinders <i>Hydraulikzylinder</i>	Monitors <i>Monitore</i>	Rotary Transmissions <i>Drehdurchführungen</i>	Slewing Gears <i>Drehgetriebe</i>	Valves <i>Ventile</i>	Variable Displacement Motors <i>Verstellmotoren</i>	Variable Displacement Pumps <i>Verstellpumpen</i>	Winch Gears <i>Windengetriebe</i>
✓	✓	✓	✓		✓	✓	✓	✓	✓	
	✓	✓	✓		✓	✓	✓	✓	✓	
	✓	✓	✓		✓	✓	✓	✓	✓	
	✓	✓	✓		✓	✓	✓	✓	✓	
	✓	✓	✓		✓	✓	✓	✓	✓	
			✓						✓	
			✓						✓	
			✓						✓	
✓			✓	✓	✓	✓	✓	✓	✓	✓
✓			✓	✓	✓	✓	✓	✓	✓	✓
✓			✓	✓	✓	✓		✓	✓	✓
✓			✓	✓	✓	✓		✓	✓	✓
			✓	✓	✓	✓	✓	✓	✓	✓
			✓	✓	✓	✓	✓	✓	✓	✓
			✓							

6.3 DIESEL PARTICULATE FILTERS

DIESELPARTIKELFILTER

Our Offer

The maintenance schedules for SENNEBOGEN machines* recommend that the diesel particulate filter should be cleaned every 5000 working hours. Within our reman program we offer low priced, regenerated filter elements for this service.

Regenerated filter elements can be ordered when planning your maintenance visits. This ensures maximum machine availability at considerably lower maintenance costs and guaranteed quality.

Unser Angebot

Wartungspläne für SENNEBOGEN Maschinen* sehen alle 5000 Betriebsstunden die Reinigung des Dieselpartikelfilters vor. Für diese Serviceleistung bieten wir kostengünstige, aufbereitete Filterelemente im Rahmen unseres Austausch-Programms an.

Sie beziehen aufbereitete Filterelemente bereits bei der Planung Ihrer Service-Einsätze. Damit sichern Sie maximale Maschinenverfügbarkeit bei deutlich geringeren Wartungskosten und garantierter Qualität.



Your Benefits

- » Maximum Machine Availability
- » Low Maintenance Costs
- » Guaranteed Quality

Ihre Vorteile

- » Maximale Maschinenverfügbarkeit
- » Geringe Wartungskosten
- » Garantierte Qualität

Description Bezeichnung	Machine Maschine	Emission Standard	No. Nr.
regenerated diesel particulate filter Aufbereiteter Dieselpartikelfilter	830E	T 4i / IIIB	163801
regenerated diesel particulate filter Aufbereiteter Dieselpartikelfilter	835E, 840E	T 4i / IIIB	163802
regenerated diesel particulate filter Aufbereiteter Dieselpartikelfilter	875E	T 4i / IIIB	163803



6.3 DIESEL PARTICULATE FILTERS / DIESELPARTIKELFILTER

The Exchange Procedure

» Step 1: Ordering regenerated filter elements

Regenerated filter elements can be ordered via the DIC. We will deliver the ordered filter elements on schedule – and charge the special net price plus the refundable deposit for every filter element delivered.

» Step 2: Returning used filter elements

Pack the filter elements upright / standing into a stable box with enough packing material to avoid damage during transportation. Attach the labels “Glass! Handle with care!” or “Fragile!” to the box, ensuring that they are clearly visible.



» Step 3: Reimbursing the deposit for used parts

Once the return delivery has been inspected and recorded, we shall refund the deposit in the form of a credit note.*

The Regeneration Process

The filter preparation is based on an environmentally friendly, certified process with recorded quality assurance. This process restores the filter capacity to at least 95 %.



contaminated
zugesetzt



regenerated
aufbereitet

Das Austauschverfahren

» **Schritt 1: Bestellung gereinigter Filterelemente**
Aufbereitete Filterelemente können per DIC bestellt werden. Wir liefern bestellte Filterelemente termingerecht und berechnen für jedes gelieferte Filterelement den Sondernettoppreis zzgl. Altteilpfand.

» **Schritt 2: Rücksendung gebrauchter Filterelemente**
Filter für die Rücksendung immer hochkant / stehend in einem stabilen Karton mit ausreichend Füllmaterial verpacken. Hinweisaufkleber „Vorsicht Glas“ oder „Bruchgefahr“ anbringen!



» Schritt 3: Erstattung Altteilpfand

Nach protokollierter Wareneingangsprüfung erstat-
ten wir den vorab erhobenen Altteilpfand in Form
einer Gutschrift.*

Das Aufbereitungsverfahren

Die Aufbereitung der Filterelemente erfolgt nach ei-
nem umweltschonenden, zertifizierten Verfahren mit
protokollierter Qualitätssicherung. Dabei wird die Fil-
terkapazität zu mindestens 95 % wieder hergestellt.

*) We reserve the right, not to refund the deposit for used parts that can no longer be recycled.

*) Wir behalten uns vor, für Alt-Teile die dem Wiederaufbereitungsprozess nicht mehr zugeführt werden können, keine Pfandgutschrift zu erteilen.

7.1 EXHAUST AFTERTREATMENT - OVERVIEW

ABGASNACHBEHANDLUNG - ÜBERSICHT

Available spare parts of the exhaust aftertreatment including schematic representation

Verfügbare Ersatzteile der Abgasmachbehandlung inkl. schematischer Darstellung

• 100 % OEM quality

• 100 % OEM Qualität

Model Modell	Engine Motor	Configuration Konfiguration	DOC	SCR	DRT	DPF
718E, 821E	QSB 4.5 - C160/119 kW	EU Stage IV / Tier 4f	178983	178982	178981	-
818E, 821E	QSB 4.5 - C130/119 kW	EU Stage III B / Tier 4i		207100		
825E	QSB 6.7 - C173/129 kW	EU Stage IV / Tier 4f			-	
825E	B 6.7 - C173/145 kW	EU Stage V / Tier 4f				
830E	QSB 6.7 - C220/164 kW	EU Stage III B / Tier 4i	on request auf Anfrage	164371	172352	-
830E	QSB 6.7 - C225/168 kW	EU Stage IV / Tier 4f				
830E	B 6.7 - C225/186 kW	EU Stage V / Tier 4f				
835E, 840E	QSL9 - C300/224 kW	EU Stage III B / Tier 4i	-	-	-	154516
835E, 840E	QSL9 - C300/224 kW	EU Stage IV / Tier 4f	172356	172355	172352	-
835E, 840E	QSL9 - C310/231 kW	EU Stage V / Tier 4f				
735E	QSL9 - C300/224 kW	EU Stage IV / Tier 4f	on request auf Anfrage	-	-	-
735E	QSL9 - C310/231 kW	EU Stage V / Tier 4f				
850E ab 850.x.2xxx	QSL9 - C300/224 kW	EU Stage IV / Tier 4f	226099	-	-	-
855E	QSL9 - C310/231 kW	EU Stage V / Tier 4f				
850E, 860E	QSG12 - C350, 261 kW	EU Stage IV / Tier 4f	191047	191048	191050	-
860E, 870E	QSG12 - C375, 261 kW	EU Stage V / Tier 4f				
875E	QSX15 - C525, 391 kW	EU Stage IV / Tier 4f	235922	235923	235924	-
875E	QSX15 - C525, 391 kW	EU Stage V / Tier 4f				

DOC: Diesel Oxidation Catalyst
DOC: Diesel-Oxidations-Katalysator

SCR: Selective Catalytic Reduction / NOx Reduction Catalyst
SCR: NOx-Reduktionskatalysator

DRT: Decomposition Reactor Tube
DRT: AdBlue / DEF-Mischrohr

DPF: Diesel Particulate Filter
DPF: Dieselpartikelfilter

7.2 DOC MODULES

DOC-MODULE

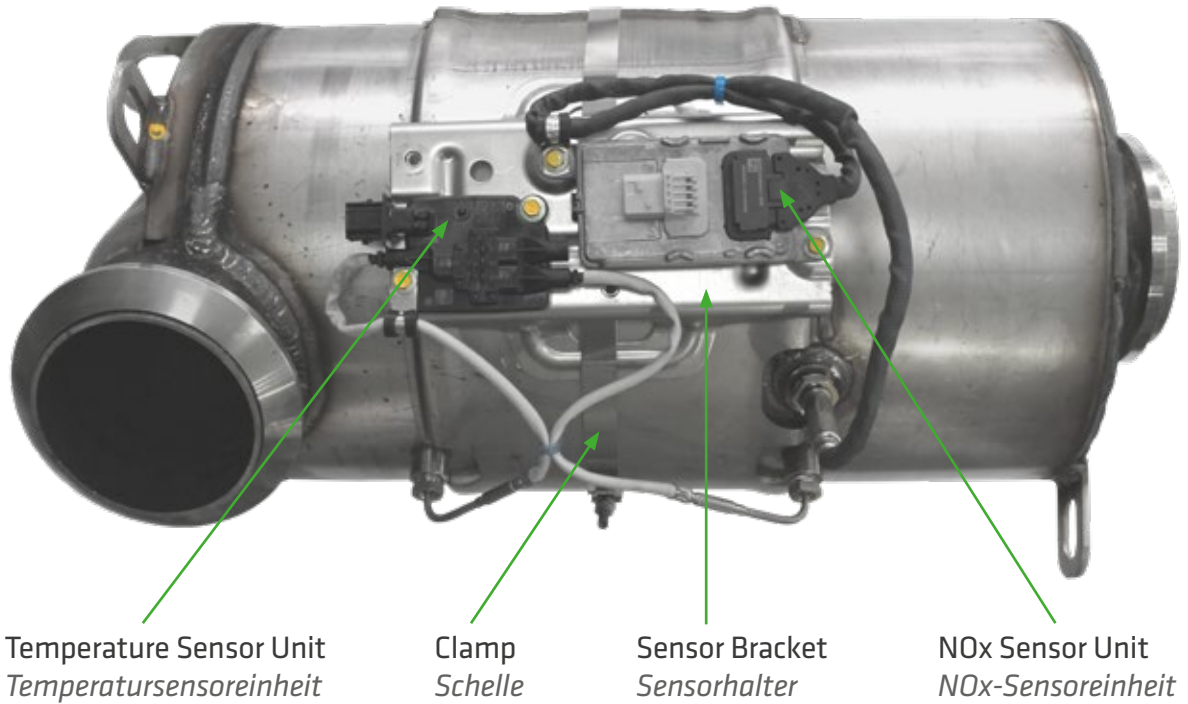

Temperature Sensor Unit
Temperatursensoreinheit

Clamp
Schelle

Sensor Bracket
Sensorhalter

NOx Sensor Unit
NOx-Sensoreinheit

Order No. / Bestellnummer 178983*

718E, 821E	QSB 4.5 - C160 / 119 kW	EU Stage IV / Tier 4f
818E, 821E	QSB 4.5 - C130 / 119 kW	EU Stage III B / Tier 4i
825E	QSB 6.7 - C173 / 129 kW	EU Stage IV / Tier 4f
825E	B 6.7 - C173 / 145 kW	EU Stage V / Tier 4f

Qty. Menge	Description Bezeichnung	No. Nr.
1	Tube Rohr	257327
1	Clamp Schelle	257328
1	Clip Clip	257329
1	Clip Clip	257330
1	Temperature Sensor Unit Temperatursensoreinheit	257331
1	NOx Sensor Unit NOx-Sensoreinheit	257332
1	Sensor Bracket Sensorhalter	257333
2	Screw Sechskantschraube	257334
2	Screw Sechskantschraube	257335
2	Zip Tie Kabelbinder	257336

Order No. / Bestellnummer 172356*

835E, 840E	QSL9 - C300 / 224 kW	EU Stage IV / Tier 4f
835E, 840E	QSL9 - C310 / 231 kW	EU Stage V / Tier 4f

Qty. Menge	Description Bezeichnung	No. Nr.
1	Sensor Bracket Sensorhalter	257333
2	Zip Tie Kabelbinder	257336
1	Clip Clip	257329
2	Screw Sechskantschraube	257334
1	Screw Sechskantschraube	257335
1	Clip Clip	257330
1	Clamp Schelle	257344
1	Temperature Sensor Unit Temperatursensoreinheit	257331
1	NOx Sensor Unit NOx-Sensoreinheit	257332
1	DOC Module DOC-Modul	172356

*) The given Order No. includes the complete module including all part numbers from the list below.
*) Die angegebene Bestellnummer enthält das Kompletต์modul inkl. aller darunter aufgelisteten Teile.

7.2 DOC MODULES / DOC-MODULE

Order No. / Bestellnummer 226099*

Qty. Menge	Description Bezeichnung	No. Nr.
850E ab 850.x.2xxx 855E	QSL9 - C300 / 224 kW QSL9 - C310 / 231 kW	EU Stage IV / Tier 4f EU Stage V / Tier 4f
1	Dosing Module / Dosiermodul	257216
1	Differential Pressure Sensor Unit / Differenzdrucksensoreinheit	257212
1	Temperature Sensor Unit / Temperatursensoreinheit	257213
3	Nut / Mutter	257211
3	Clamp / Schelle	257210
3	Seal / Dichtung	257207
1	DRT Module / DRT-Modul	257209
1	DPF Module / DPF-Modul	257208
1	NOx Sensor Unit / NOx-Sensoreinheit	257988
1	NOx Sensor Unit / NOx-Sensoreinheit	257989

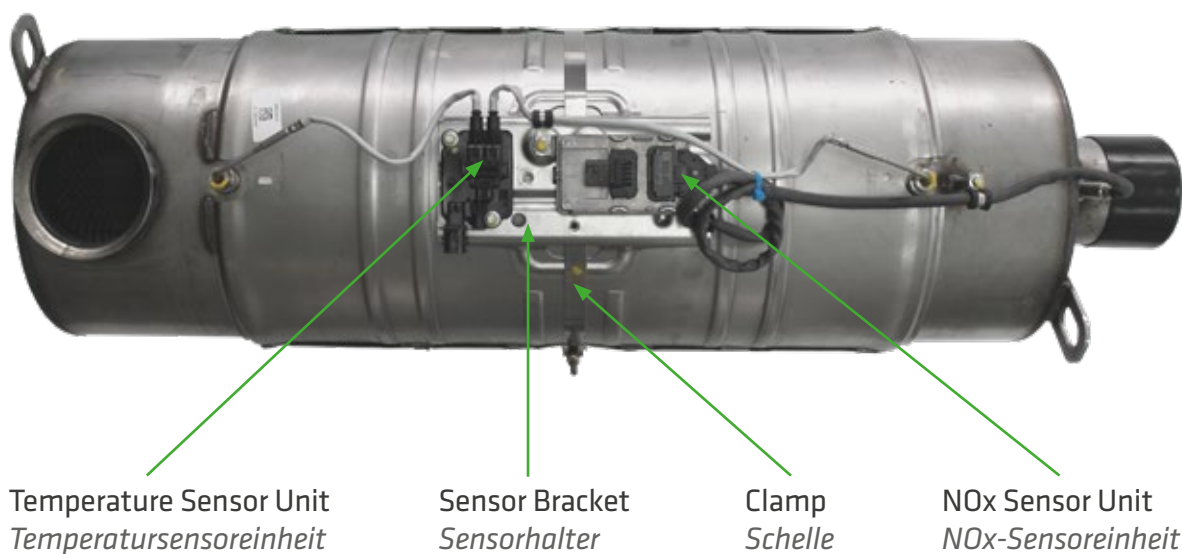
7.3 SCR MODULES
SCR-MODULE

7.3 SCR MODULES / SCR-MODULE

Order No. / Bestellnummer 178982*

Qty. Menge	Description Bezeichnung	No. Nr.
718E, 821E	QSB 4.5 - C160 / 119 kW	EU Stage IV / Tier 4f
818E, 821E	QSB 4.5 - C130 / 119 kW	EU Stage III B / Tier 4i
2	Clip Clip	257330
1	Sensor Bracket Sensorhalter	257333
4	Zip Tie Kabelbinder	257336
1	Clip Clip	257329
1	Screw Sechskantschraube	257334
1	Screw Sechskantschraube	257335
1	Screw Sechskantschraube	257342
1	NOx Sensor Unit NOx-Sensoreinheit	257343
1	Clamp Schelle	257344
1	Tube Rohr	257345
1	Plain Washer Scheibe	257346
1	Temperature Sensor Unit Temperatursensoreinheit	257348

Order No. / Bestellnummer 164371*

Qty. Menge	Description Bezeichnung	No. Nr.
830E	QSB 6.7 - C220 / 164 kW	EU Stage III B / Tier 4i
830E	QSB 6.7 - C225 / 168 kW	EU Stage IV / Tier 4f
830E	B 6.7 - C225 / 186 kW	EU Stage V / Tier 4f
1	Zip Tie Kabelbinder	257336
2	Clip Clip	257329
3	Screw Sechskantschraube	257334
1	Screw Sechskantschraube	257335
1	Tube Rohr	257406
1	Clip Clip	257330
1	Clamp Schelle	257344
1	NOx Sensor Unit NOx-Sensoreinheit	on request auf Anfrage
1	Temperature Sensor Unit Temperatursensoreinheit	257348
1	Sensor Bracket Sensorhalter	257333

Order No. / Bestellnummer 207100*

Qty. Menge	Description Bezeichnung	No. Nr.
825E	QSB 6.7 - C173 / 129 kW	EU Stage IV / Tier 4f
825E	B 6.7 - C173 / 145 kW	EU Stage V / Tier 4f
2	Clip Clip	257330
1	Sensor Bracket Sensorhalter	257333
4	Zip Tie Kabelbinder	257336
1	Clip Clip	257329
2	Screw Sechskantschraube	257334
2	Screw Sechskantschraube	257335
1	Screw Sechskantschraube	257342
1	NOx Sensor Unit NOx-Sensoreinheit	257343
1	Clamp Schelle	257344
1	Plain Washer Scheibe	257346
1	Temperature Sensor Unit Temperatursensoreinheit	257348
1	Tube Rohr	257368

Order No. / Bestellnummer 172355*

Qty. Menge	Description Bezeichnung	No. Nr.
835E, 840E	QSL9 - C300 / 224 kW	EU Stage IV / Tier 4f
835E, 840E	QSL9 - C310 / 231 kW	EU Stage V / Tier 4f
1	Clip Clip	257330
1	Sensor Bracket Sensorhalter	257333
1	Zip Tie Kabelbinder	257336
2	Clip Clip	257329
3	Screw Sechskantschraube	257334
2	Screw Sechskantschraube	257335
1	Clamp Schelle	257344
1	NOx Sensor Unit NOx-Sensoreinheit	on request auf Anfrage
1	Temperature Sensor Unit Temperatursensoreinheit	257348
1	SCR Module SCR-Modul	172355

*) The given Order No. includes the complete module including all part numbers from the list below.
*) Die angegebene Bestellnummer enthält das Kompletต์modul inkl. aller darunter aufgelisteten Teile.

7.4 DRT MODULES

DRT-MODULE



Dosing Module
Dosiermodul

Pipe
Rohr

Order No. / Bestellnummer 178981*

718E, 821E	QSB 4.5 - C160 / 119 kW	EU Stage IV / Tier 4f
818E, 821E	QSB 4.5 - C130 / 119 kW	EU Stage III B / Tier 4i
825E	QSB 6.7 - C173 / 129 kW	EU Stage IV / Tier 4f
825E	B 6.7 - C173 / 145 kW	EU Stage V / Tier 4f

Qty. <i>Menge</i>	Description <i>Bezeichnung</i>	No. <i>Nr.</i>
1	Dosing Module <i>Dosiermodul</i>	257362
3	Screw <i>Sechskantschraube</i>	257363
1	Seal <i>Dichtung</i>	257364
3	Spacer <i>Distanzstück</i>	257365
1	Tube <i>Rohr</i>	257366

Order No. / Bestellnummer 172352*

830E	QSB 6.7 - C220 / 164 kW	EU Stage III B / Tier 4i
830E	QSB 6.7 - C225 / 168 kW	EU Stage IV / Tier 4f
830E	B 6.7 - C225 / 186 kW	EU Stage V / Tier 4f
835E, 840E	QSL9 - C300 / 224 kW	EU Stage IV / Tier 4f
835E, 840E	QSL9 - C310 / 231 kW	EU Stage V / Tier 4f
735E	QSL9 - C300 / 224 kW	EU Stage IV / Tier 4f
735E	QSL9 - C310 / 231 kW	EU Stage V / Tier 4f

Qty. <i>Menge</i>	Description <i>Bezeichnung</i>	No. <i>Nr.</i>
1	Protection <i>Schutz</i>	257373
2	Oval-Head Bolt <i>Linsenschraube</i>	257374
3	Screw <i>Sechskantschraube</i>	257335
1	Dosing Module <i>Dosiermodul</i>	225826
1	Seal <i>Dichtung</i>	257364
1	Tube <i>Rohr</i>	257375

7.4 DRT MODULES / DRT-MODULE

Order No. / Bestellnummer 191050*

850E, 860E	QSG12 - C350 / 261 kW	EU Stage IV / Tier 4f
860E, 870E	QSG12 - C375 / 261 kW	EU Stage V / Tier 4f

Qty. Menge	Description Bezeichnung	No. Nr.
3	Screw <i>Sechskantschraube</i>	257335
1	Dosing Module <i>Dosiermodul</i>	257403
1	Tube <i>Rohr</i>	257404
3	Spacer <i>Distanzstück</i>	257405

Order No. / Bestellnummer 235924*

875E	QSX15 - C525 / 391 kW	EU Stage IV / Tier 4f
875E	QSX15 - C525 / 391 kW	EU Stage V / Tier 4f

Qty. Menge	Description Bezeichnung	No. Nr.
3	Screw <i>Sechskantschraube</i>	257335
1	Seal <i>Dichtung</i>	257364
1	Protection <i>Schutz</i>	257373
2	Oval-Head Bolt <i>Linsenschraube</i>	257374
1	Dosing Module <i>Dosiermodul</i>	257408
1	Tube <i>Rohr</i>	257407

7.5 DPF MODULES DPF-MODULE

Order No. / Bestellnummer 154516*

835E, 840E	QSL9 - C300 / 224 kW	EU Stage III B / Tier 4i
------------	----------------------	--------------------------

Qty. Menge	Description Bezeichnung	No. Nr.
1	Seal / <i>Dichtung</i>	157857
2	Clip / <i>Clip</i>	257330
1	Filter Element (Exhaust Aftertreatment) / <i>Filterelement (Abgasnachbehandlung)</i>	257382
1	Filter Element (DPF) / <i>Filterelement (DPF)</i>	157853
2	Seal / <i>Dichtung</i>	257383
1	Temperature Sensor Unit / <i>Temperatursensoreinheit</i>	257384
2	Temperature Sensor Unit / <i>Temperatursensoreinheit</i>	257385
1	Screw / <i>Sechskantschraube</i>	257342
1	Clamp / <i>Schelle</i>	157858
2	Washer / <i>Scheibe</i>	257387
2	Striker Bow / <i>Bügel</i>	257388
1	Filter Element (Exhaust Aftertreatment) / <i>Filterelement (Abgasnachbehandlung)</i>	257389
1	Washer / <i>Scheibe</i>	257346
1	Clamp / <i>Schelle</i>	257390
2	Clamp / <i>Schelle</i>	157855
1	Wiring / <i>Verkabelung</i>	257391
1	Clip / <i>Clip</i>	257392
2	Nut / <i>Sechskantmutter</i>	257393
1	Clip / <i>Clip</i>	257394
3	Clamp / <i>Schelle</i>	257395
1	Tube / <i>Rohr</i>	257396
1	Tube / <i>Rohr</i>	257397
1	Sensor Bracket / <i>Sensorhalter</i>	257399

*) The given Order No. includes the complete module including all part numbers from the list below.
*) Die angegeben Bestellnummer enthält das Kompletmodul inkl. aller darunter aufgelisteten Teile.

8.1 MULTI LINE ACCESSORY EQUIPMENT

MULTI LINE ANBAUGERÄTE

Shovels / Schaufeln



Category Kategorie	Description Bezeichnung	Volume Volumen	Max. Bulk Density Schüttgut- dichte	Width Breite	Weight Gewicht	No. (VOLVO QCS) Nr. (VOLVO SW)	No. (SEBO QCS) Nr. (SEBO SW)
1	Earth Bucket with teeth Erdschaufel mit Zähnen	1,6 m ³	1,8 kg/l	2500 mm	ca. 610 – 690 kg	255471	255470
1	Earth Bucket w/o teeth Erdschaufel ohne Zähne	1,6 m ³	1,8 kg/l	2500 mm	ca. 580 – 660 kg	255417	255416
2	Loading Shovel Ladeschaufel	2,5 m ³	1,2 kg/l	2550 mm	ca. 620 – 700 kg	255419	255418
2	Loading Shovel Ladeschaufel	3,0 m ³	1,1 kg/l	2550 mm	ca. 670 – 750 kg	255421	255420
3	Hold-Down-Shovel (Opening Range: 2200 mm) Niederhalterschaufel (Öffnungsweite 2200 mm)	2,5 m ³	1,4 kg/l	2550 mm	1485 kg	255467	255451
3	Hold-Down-Shovel (Opening Range: 2200 mm) Niederhalterschaufel (Öffnungsweite 2200 mm)	3,0 m ³	1,0 kg/l	2550 mm	1570 kg	255469	255468
4	Light Material Bucket Schüttgutschaufel	3,5 m ³	1,0 kg/l	2550 mm	ca. 810 – 890 kg	254594	254575
4	Light Material Bucket Schüttgutschaufel	4,0 m ³	0,9 kg/l	2550 mm	ca. 860 – 920 kg	254595	254576

Material Material	Condition Beschaffenheit	t/m ³ t/m ³	% %	Recomm. Empfehlung
Gravel / Kies	moist / feucht	1,9	105	1
	dry / trocken	1,6	105	1
	grit / Split	1,5	100	1
Sand / Sand	dry / trocken	1,5	105	1
	wet / nass	1,9	110	1
Gravel Sand / Kiessand	dry / trocken	1,7	105	1
	wet / nass	2,0	100	1
Sand, Clay / Sand, Ton		1,6	110	1
Clay / Ton	natural / natürlich	1,6	110	1
	hard / hart	1,4	110	1
Clay, Gravel / Ton, Kies	dry / trocken	1,4	110	1
	wet / nass	1,6	100	1
Soil / Erde	dry / trocken	1,3	115	1
	wet / nass	1,6	100	2
Topsoil / Mutterboden		1,1	110	1
Basalt / Basalt		1,95	110	1
Granite / Granit		1,8	95	1
Sandstone / Sandstein		1,6	100	1
Slate / Schiefer		1,75	100	1

Material Material	Condition Beschaffenheit	t/m ³ t/m ³	% %	Recomm. Empfehlung
Bauxite / Bauxit		1,4	100	1
Limestone / Kalkstein		1,6	100	1
Gypsum / Gips	broken / gebrochen	1,8	100	1
		0,5	110	4
Coke / Koks		0,5	110	4
Slag / Schlacke	broken / gebrochen	1,8	100	1
Glass Waste / Glasabfälle	broken / gebrochen	1,4	100	3
	whole / ganz	1,0	100	3
Compost / Kompost	dry / trocken	0,8	105	3 4
	wet / nass	1,0	100	3 4
Wood Chips, Sawdust / Hackschnitzel, Sägespäne		0,5	110	4
Paper / Papier	shredded / geschreddert	0,6	110	3 4
	cardboard / Karton	1,0	110	3 4
Coal / Kohle	heavy / schwer	1,2	110	2
	light / leicht	0,9	110	2
Garbage / Müll	househ. waste / Hausmüll	0,5	100	3 4
	bulk waste / Sperrmüll	1,0	100	3 4

8.1 MULTI LINE ACCESSORY EQUIPMENT / MULTI LINE ANBAUGERÄTE



Mounting Plates / Anbauplatten

Description Bezeichnung	Max. Load Tragfähigkeit	Width Breite	Weight Gewicht	No. Nr.
Attachment Plate Category 4A Anbauplatte Klasse 4A	5500 kg	1500 mm	340 kg	233179
Attachment Plate Category 3B Anbauplatte Klasse 3B	4990 kg	1500 mm	240 kg	082649

Mounting Plate
Anbauplatte



Lifting Forks / Hubgabeln

Description Bezeichnung	Max. Load Tragfähigkeit	Width Breite	Weight Gewicht	No. Nr.
Lifting Fork incl. Attachment Plate Hubgabel inkl. Anbauplatte	5500 kg (LSP 600 mm)	1200 mm	570 kg	259711
Lifting Fork incl. Attachment Plate Hubgabel inkl. Anbauplatte	5500 kg (LSP 600 mm)	1500 mm	615 kg	259712
Load Protection Guard Lastschutzgitter	-	-	-	091236
Fork Positioner incl. Attachment Plate 4A and Fork Arms Zinkenverstellgerät inkl. Anbauplatte 4A und Gabelzinken	5500 kg	1500 mm	670 + 340 kg	238355

Lifting Fork
Hubgabel



**Fork Positioner
(incl. Tools)**
Zinkenverstellgerät
(inkl. Zubehör)



Other Accessory Equipment / Andere Anbaugeräte

Description Bezeichnung	Fork Arm Length Gabelzinkenlänge	Width Baubreite	No. Nr.
Large Bale Fork - heavy design Großballengabel mit vier Zinken	980 mm	2000 mm	241671
SENNEBOGEN Quick Change System SENNEBOGEN Schnellwechsellvorrichtung		1075 mm	259702
VOLVO Quick Change System (Type L50/60/70 C/D/E) VOLVO Schnellwechsellvorrichtung (Typ L50/60/70 C/D/E)		1175 mm	259701

VOLVO QCS
VOLVO SW



8.2 ORANGE PEEL GRAB SGM - OVERVIEW

MEHRSCHALENGREIFER SGM - ÜBERSICHT

Optimized Hydraulic Flow *Optimierter Hydraulikfluss*

- Fast opening of grab
- High closing forces
- Schnelles Öffnen des Greifers
- Hohe Schließkräfte

Cast Steel Crosshead at SGM.30/.40 Series *Stahlgussstraverse bei der Serie SGM.30/.40*

- High tensile strength
- No tension because of no weld seams
- Long-life cycle
- Hohe Zugfestigkeit
- Keine Spannungen, da keine Schweißnähte
- Langlebigkeit

Shell Pivot Bearing *Schalendrehpunkt- lagerung*

- Sealed
- Closed, hardened steel-bushes
- Abgedichtet
- Geschlossene, vergütete Stahlbuchsen

Forged Shell-Tips *Geschmiedete Schalenspitzen*

- Exchangeable
- Manganese steel
- Austauschbar
- Manganstahl

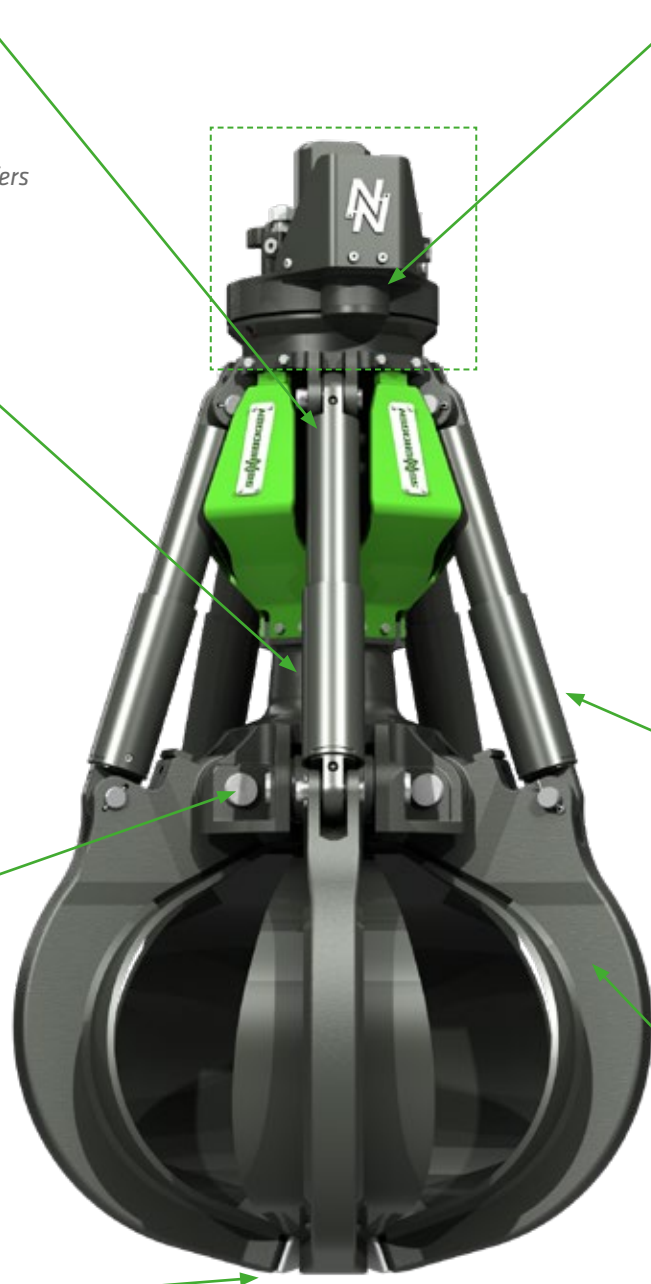

Endless Hydraulic Rotary Drive DKS *Endloser hydraulischer Drehantrieb DKS*

- Easy to maintain
- Bush bearing for absorbing axial and radial forces
- High torque
- Capsuled bearing
- Capsuled rotor
- External drive motor
- Service- und wartungsfreundlich
- Gleitlagerung zur Aufnahme der Axial- und Radialbelastung
- Hohes Drehmoment
- Gekapselte Lagerung
- Gekapselte Drehdurchführung
- Externer Antriebsmotor

Hydraulic Cylinder *Hydraulikzylinder*

- End cushioning
- Hardened piston rod
- Endlagendämpfung
- Vergütete Kolbenstange

Shells *Schalen*

- Entirely made of fine-grained steel
- Series SGM.30/.40-shell corpus made of cast steel
- Different shell-profiles available
- Komplett aus Feinkornstahl
- Serie SGM.30/.40-Schalenkorpus aus Stahlguss
- Verschiedene Schalenformen lieferbar

8.2 ORANGE PEEL GRAB SGM – OVERVIEW

MEHRSCHALENGREIFER SGM – ÜBERSICHT

Optional Equipment

Ausrüstungsoptionen

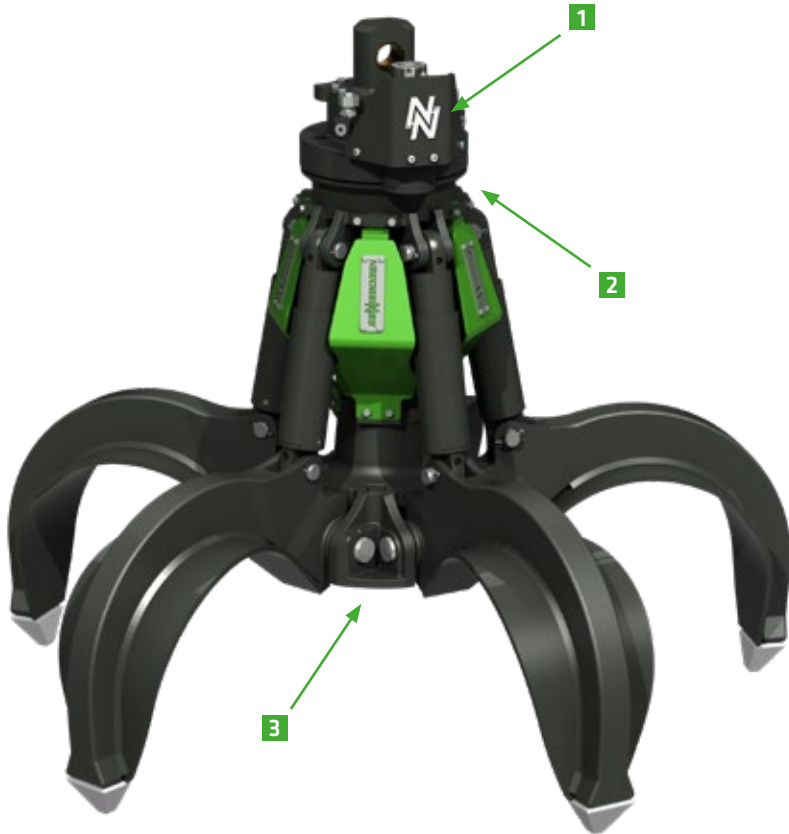

Rotor with electricity feethrough of 24 / 230 V, e.g. using detectors or magnets
 Drehwerk mit Stromdurchführung für 24 / 230 V, z. B. Detektoren / Magneteinsatz



Second rotary drive for more torque at high rotational load
 Zweiter Drehmotor für mehr Drehmoment bei großer Drehbelastung



Standard grab with integrated magnet safety device, perfect for magnets with grab arbor
 Standardgreifer mit integrierter Magnetsicherung, passend für Magnete mit Aufnahmedorn

Shell Profiles

Schalenformen

Shell profile: half opened (HO)
 Schalenform: halboffen (HO)

Shell profile: closed (G)
 Schalenform: geschlossen (G)



8.3 ORANGE PEEL GRAB SGM (4 SHELLS) MEHRSCHALENGREIFER SGM (4 SCHALEN)

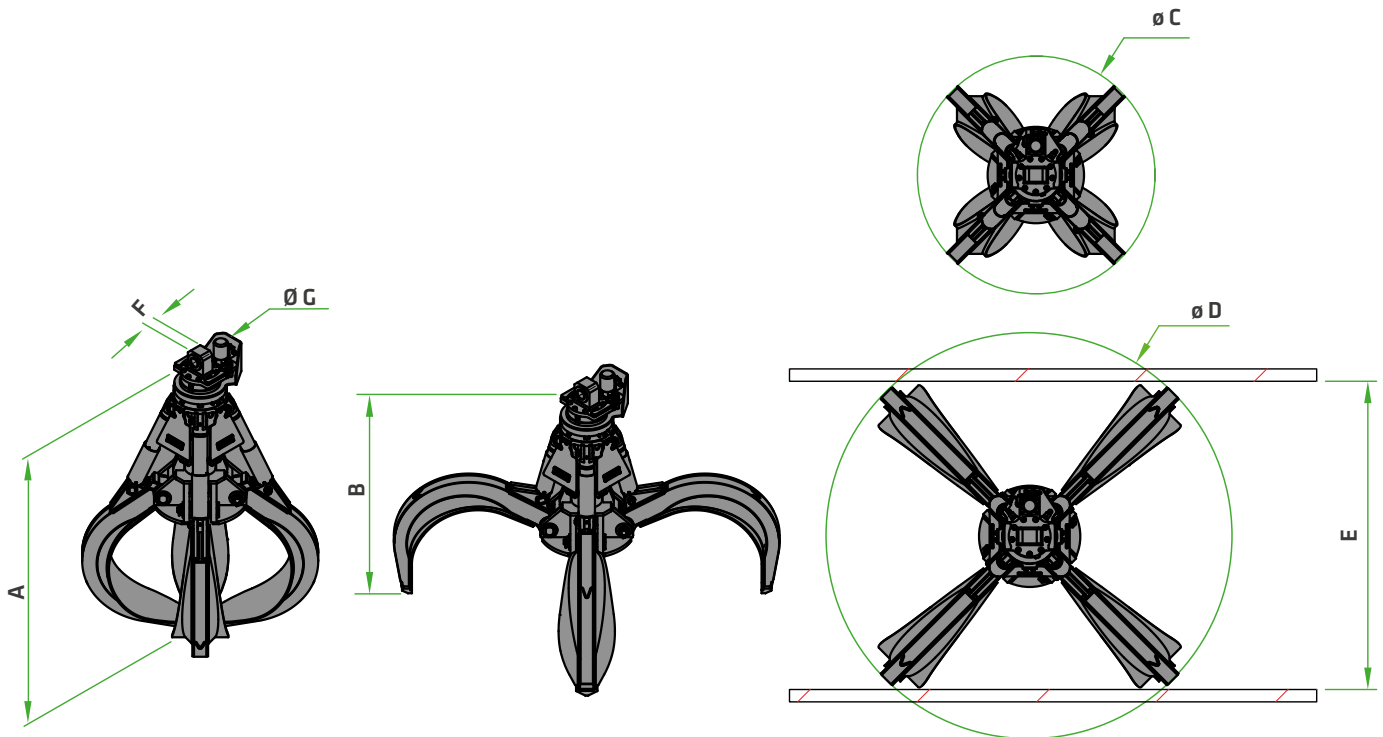

Type / Size Bauart / Baugröße	Rotor Drehwerk	Grab Capacity Greiferinhalt	Weight ¹ Gewicht ¹		Dimensions (mm) Abmessungen (mm)						
			Form of Shell ² Schalenform ²								

HO	G
----	---

SGM		l	kg	kg	A	B	C	D	E	F	G
500.20-4	DKS 10	500	835	975	1665	1355	1420	2320	1740	114	70
600.30-4	DKS 16	600	1300	1435	2345	1855	1390	2430	1830	114	70
800.30-4	DKS 16	800	1345	1510	2490	1900	1450	2700	2025	114	70
400.40-4	DKS 16	400	1570	1720	2185	1790	1350	2160	1530	114	70
600.40-4	DKS 16	600	1600	1790	2270	1820	1360	2320	1640	114	70
800.40-4	DKS 16	800	1685	1930	2405	1865	1540	2600	1840	114	70
1000.40-4	DKS 16-2	1000	1755	2085	2515	1900	1680	2800	1980	114	70
1250.40-4	DKS 16-2	1250	1850	2200	2650	1945	1770	3100	2200	114	70
800.50-4	DKS 26	800	2245	2490	2500	2065	1600	2640	1870	149	80
1000.50-4	DKS 26	1000	2345	2585	2605	2100	1670	2850	2020	149	80
1500.50-4	DKS 26	1500	2475	2830	2750	2150	1880	3150	2230	149	80
2000.50-4	DKS 26	2000	2660	3075	2880	2190	2100	3420	2420	149	80

1) Declaration of weight without grab suspension / 1) Gewichtsangaben ohne Greiferaufhängung
 2) Half open-shells: Shellplate-width 400 mm, as of capacity 1250 l shellplate-width 500 mm
 2) Halboffene Schalen: Schalenblech 400 mm breit, ab Inhalt 1250 l Schalenblech 500 mm breit

Subject to technical modification.
 Technische Änderungen vorbehalten.

8.3 ORANGE PEEL GRAB SGM (4 SHELLS) MEHRSCHALENGREIFER SGM (4 SCHALEN)

Technical data Technische Daten

» The main benefits of the 4-shells-series

- Simple and clear dipping into containers or other repositories
- Safe grab closure with bulky goods, e.g. bars, autobodies

» Die wesentlichen Vorteile der 4-Arm-Serien

- Einfaches und sauberes Eintauchen in Container oder andere Behältnisse
- Sicherer Greifschluss bei sperrigen Materialien, z. B. Langmaterial, Autokarossern

The handled material affects the wear behavior of the grab in significant ways. If appropriate, please ask for our heavy duty-solutions.

Das Umschlaggut beeinflusst maßgeblich das Verschleißverhalten des Greifers. Bitte erkundigen Sie sich ggf. nach unseren Lösungen für Schwereinsätze.



Grab weighs less
Approx. 13 % more payload as with five shells

Weniger Greifergewicht
ca. 13 % mehr Nutzlast als mit 5 Schalen

Number of Shells ² Anzahl Schalen ²	max. Piled Density max. Schüttdichte	Machine Type Maschinentyp													Type / Size Bauart / Baugröße	Order No. Bestellnummer		
		817	818	821	825	830	835	840	850	855	860	870	875	880		SGM	HO	G
4	2,0														500.20-4		215654	
4	2,0														600.30-4	248335	248543	
															800.30-4	248544	248545	
4	2,0														400.40-4	205410	205411	
															600.40-4	205412	205413	
															800.40-4	205414	205415	
																1000.40-4	205423	205424
																1250.40-4	205425	205426
4	2,0														800.50-4	170723	170724	
															1000.50-4	170725	170726	
															1500.50-4	237352	170728	
															2000.50-4	189541	170730	
Weight of Suspension Gewicht Greiferaufhängung		67 kg					136 kg					145 kg						

8.4 ORANGE PEEL GRAB SGM (5/6 SHELLS) MEHRSCHALENGREIFER SGM (5/6 SCHALEN)

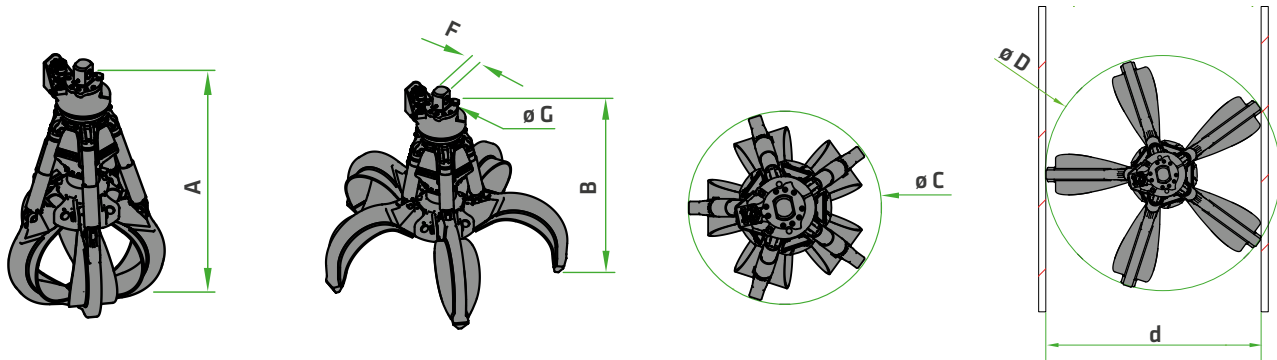

Type / Size Bauart / Baugröße	Rotor Drehwerk	Grab Capacity Greiferinhalt	Weight ¹ Gewicht ¹		Dimensions (mm) Abmessungen (mm)							
			Form of Shell ² Schalenform ²									
			HO	G								
SGM		l	kg	kg	A	B	C	D	d ^(HO)	d ^(G)	F	G
500.20	DKS 10	500	990	1085	1655	1355	1420	2320	3130	2160	114	70
600.30	DKS 16	600	1490	1580	2335	1845	1390	2430	2230	2265	114	70
800.30	DKS 16	800	1540	1650	2490	1905	1450	2700	2470	2505	114	70
400.40	DKS 16	400	1820	1920	2185	1790	1350	2160	1990	2015	114	70
600.40	DKS 16	600	1910	2035	2270	1820	1360	2320	2120	2180	114	70
800.40	DKS 16	800	1960	2140	2405	1865	1540	2600	2380	2420	114	70
1000.40	DKS 16-2	1000	2040	2290	2515	1900	1680	2800	2565	2635	114	70
1250.40	DKS 16-2	1250	2180	2415	2650	1945	1770	3100	2835	2870	114	70
1400.40	DKS 16-2	1400	2250	2500	2685	1960	1780	3200	2920	2955	114	70
800.50	DKS 26	800	2580	2740	2500	2065	1600	2640	2425	2485	149	80
1000.50	DKS 26	1000	2710	2870	2610	2100	1670	2850	2620	2675	149	80
1500.50	DKS 26	1500	2860	3100	2750	2150	1880	3150	2895	2965	149	80
2000.50	DKS 26	2000	3060	3370	2875	2195	2100	3420	3140	3220	149	80
2500.50	DKS 26-2	2500	3130	3615	3000	2240	2315	3700	3445	3490	149	80
3000.50	DKS 26-2	3000	3250	3875	3150	2285	2270	3950	3750	3770	149	80
2500.60	DKS 35-2	2500	4120	4510	3425	2630	2270	3910	3575	3625	200	80
3000.60	DKS 35-2	3000	4180	4550	3530	2670	2285	4100	3730	3810	200	80
3500.60	DKS 35-2	3500	4270	4780	3595	2690	2420	4220	3860	3960	200	80
4000.60	DKS 35-2	4000	4330	4920	3650	2710	2530	4350	3965	4055	200	80
3000.70	DKS 40	3000	7015	7360	4160	3520	2600	4350	3840	3840	200	80
4000.70	DKS 40	4000	7160	7560	4250	3560	2850	4570	4020	4020	200	80
5000.70	DKS 40	5000	7250	7830	4315	3585	3050	4740	4180	4180	200	80

1) Declaration of weight without grab suspension / 1) Gewichtsangaben ohne Greiferaufhängung
 2) Half open-shells: Shellplate-width 400 mm, as of capacity 1250 l shellplate-width 500 mm
 2) Halboffene Schalen: Schalenblech 400 mm breit, ab Inhalt 1250 l Schalenblech 500 mm breit

8.4 ORANGE PEEL GRAB SGM (5/6 SHELLS) MEHRSCHALENGREIFER SGM (5/6 SCHALEN)



Technical data Technische Daten

The handled material affects the wear behavior of the grab in significant ways. If appropriate, please ask for our heavy duty-solutions.

Das Umschlaggut beeinflusst maßgeblich das Verschleißverhalten des Greifers. Bitte erkundigen Sie sich ggf. nach unseren Lösungen für Schwereinsätze.

Number of Shells ² Anzahl Schalen ²	Max. Piled Density Max. Schüttdichte	Machine Type Maschinentyp														Type / Size Bauart / Baugröße	Order No. Bestellnummer	
		817	818	821	825	830	835	840	850	855	860	870	875	880	SGM		HO	G
5	2,0														500.20		226991	
5	2,0														600.30	244987	248538	
															800.30	248539	248540	
5	2,0														400.40	205400	205229	
															600.40	205401	205402	
															800.40	205403	205404	
															1000.40	205405	205406	
															1250.40	205407	205408	
															1400.40	205422	205409	
5	2,0													800.50	205708	205709		
														1000.50	205710	205711		
														1500.50	205695	205712		
														2000.50	205713	205714		
														2500.50	181229	189325		
														3000.50	205715	-		
5	2,0													2500.60	258787	261392		
														3000.60	261393	251933		
														3500.60	261394	261396		
														4000.60	261398	251905		
6	2,0													3000.70	169512	169513		
														4000.70	169514	169515		
														5000.70	169516	169517		
Weight of Suspension Gewicht Greiferaufhängung		67 kg				136 kg				145 kg				225 kg				

8.5 CLAMSHELL SGZ - OVERVIEW

ZWEISCHALENGREIFER SGZ - ÜBERSICHT

Crosshead Traverse

- Torsion-resistant crosshead
- Verwindungssteife Traverse

Shell Pivot & Synchron Control Schalendrehpunkte & Gleichlauflenkung

- Sealed bearing
- Generous dimensioned shell pivots
- Abgedichtetes Lager
- Großzügig dimensionierte Schalendrehpunkte

Opening- & Closing-Bedstops Öffnungs- & Schließanschläge

- To protect the hydraulic system
- Made of fine-grained steel
- Zum Schutz der Hydraulik
- Aus Feinkornstahl

Main erosion area Hauptverschleißbereich

- Additional changeable erosion blades in series
- Zusätzlich eingesetzte, wechselbare Verschleiß-schneiden in Serie

Erosion Blades Verschleißschneiden

- Bottom- and side-blades made of fine-grained steel
- Exchangeable
- Boden- und Seitenschneiden aus Feinkornstahl
- Austauschbar

Endless Hydraulic Rotary Drive DKS Endloser hydraulischer Drehantrieb DKS

- Capsuled bearing
- Capsuled rotor
- External drive motor
- Gekapselte Lagerung
- Gekapselte Drehdurchführung
- Externer Antriebsmotor

Hydraulic Cylinder Hydraulikzylinder

- End cushioning
- Hardened piston rod
- Robust and easy serviceable piston rod protection
- Endlagendämpfung
- Vergütete Kolbenstange
- Robuster und servicefreundlicher Kolbenstangenschutz

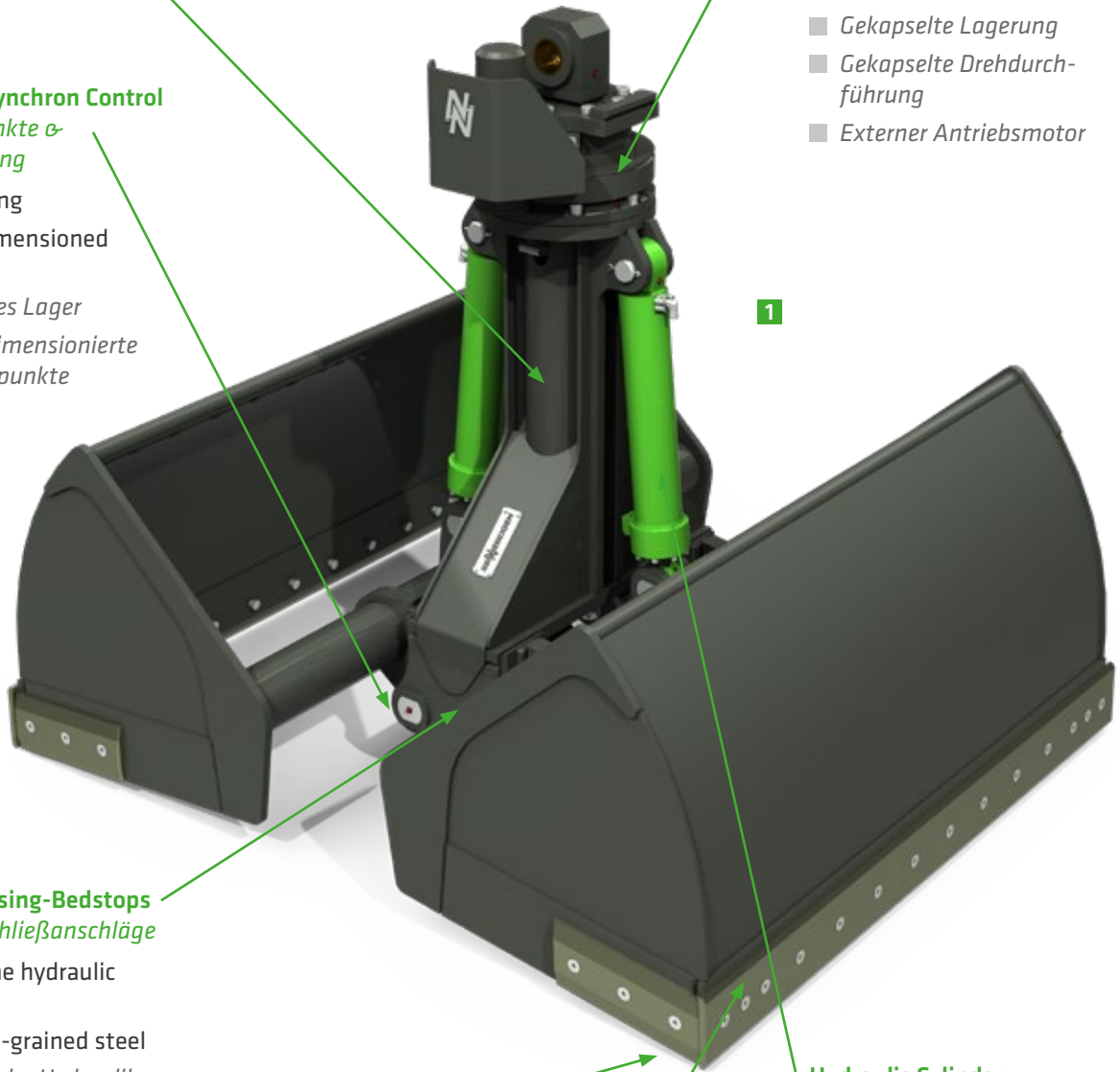

8.5 CLAMSHELL SGZ - OVERVIEW / ZWEISCHALENGREIFER SGZ - ÜBERSICHT

You will find our full range of attachments in our Attachments brochure.

Unser gesamtes Sortiment an Anbaugeräten finden Sie in unserem Anbaugeräte-Prospekt.



1

Standard Shell Standardschale

- Universal shell for gravel, sand, etc.
- Great stability and closing force
- Exchangeable blades
- *Universalschale für Kies, Sand, etc.*
- *Hohe Stabilität und Kraft*
- *Wechselbare Verschleißschneiden*



3

Light Goods Shell Leichtgutschale

- For free flowing goods with low abrasion
- Designed for volume, lightweight construction
- Low weight, high load capacity
- *Für fließende Schüttgüter mit geringer Abrasivität*
- *Ausgelegt auf Volumen und Leichtbau*
- *Geringes Eigengewicht, viel Inhalt*

2

Heavy Duty Shell with changeable Blades HD-Schale mit Wechselmessern

- For heavy duty
- Shells completely made of Hardox 450
- Additional wear plates
- Exchangeable blades
- *Für härtesten Einsatz*
- *Schalen komplett aus Hardox 450*
- *Zusätzliche Verschleißbleche*
- *Wechselbare Verschleißschneiden*

4

Coal Shell (Option) Kohle-Schale (Option)

- Shell for goods with steep repose angle, e.g. loose coal
- Best filling of grab
- *Schale für Schüttgüter mit steilem Schüttwinkel, z. B. lose Kohle*
- *Optimale Füllung des Greifers*

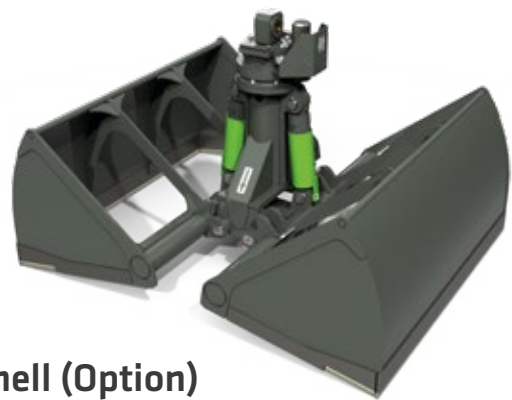

8.6 CLAMSHELL SGZ ZWEISCHALENGREIFER SGZ

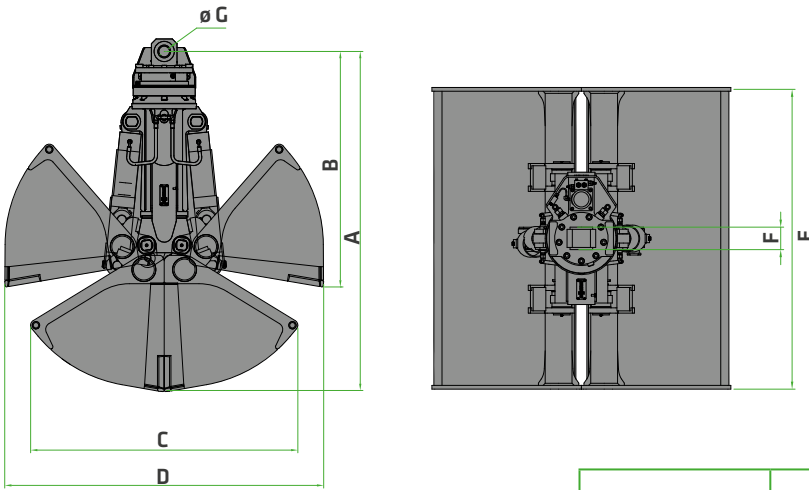

Type / Size Bauart / Baugröße	Rotor Drehwerk	Grab Capacity Greiferinhalt	Weight ¹ Gewicht ¹
----------------------------------	-------------------	--------------------------------	---

SGZ		l	kg
1000.40	DKS 16	1000	1270
1200.40	DKS 16	1200	1360
1400.40	DKS 16	1400	1420
1600.40	DKS 16	1600	1530
1500.50	DKS 26	1500	1950
2000.50	DKS 26	2000	2200
2500.50	DKS 26	2500	2300
3000.50	DKS 26	3000	2490
4000.50	DKS 26	4000	2880
2500.60	DKS 35-2	2500	2850
3000.60	DKS 35-2	3000	3030
3500.60	DKS 35-2	3500	3320
4000.60	DKS 35-2	4000	3420
5000.70	DKS 40	5000	6500
6000.70	DKS 40	6000	6800
7000.70	DKS 40	7000	7550
8000.70	DKS 40	8000	7850

standard shell / Standardschale (1,0 - 2,6 t/m³)

Material ² Material ²	Piled Density Schüttdichte
	t/m ³
used sand Altsand	1,5
cullet Bruchglas	1,9
soil, wet Erde, nass	1,8
gypsum Gips	1,3
chalk Kalk	1,1
gravel, earth-moist Kies, erdfeucht	1,8
salt Salz	1,2
sand Sand	2,1
broken rock, split Schotter, Split	1,6

8.6 CLAMSHELL SGZ / ZWEISCHALENGREIFER SGZ

The handled material affects the wear behavior of the grab in significant ways. If appropriate, please ask for our heavy duty-solutions.

Das Umschlaggut beeinflusst maßgeblich das Verschleißverhalten des Greifers.
Bitte erkundigen Sie sich ggf. nach unseren Lösungen für Schwereinsätze.

Dimensions (mm) Abmessungen (mm)							Max. piled density Max. Schüttdichte	Machine Type Maschinentyp										Type / Size Bauart / Baugröße	Order No. Bestellnummer								
A	B	C	D	E	F	G	t/m ³	817	818	821	825	830	835	840	850	855	860	870	875	880	SGZ						
2490	1790	1770	2130	1100	114	70	2,0															1000.40	205716				
2490	1790	1770	2130	1400	114	70																	1200.40	205718			
2490	1790	1770	2130	1600	114	70																		1400.40	205719		
2490	1790	1770	2130	1800	114	70																			1600.40	205721	
2490	1720	1980	2360	1200	114	70	2,6																1500.50	205731			
2490	1720	1980	2360	1600	114	70																			2000.50	205732	
2490	1720	1980	2360	2000	114	70	2,0																	2500.50	205733		
2490	1720	1980	2360	2400	114	70																				3000.50	205734
2490	1720	2160	2700	2400	114	70	1,6																	4000.50	205737		
3400	2390	2380	2860	1500	200	80	2,6																	2500.60	238952		
3400	2390	2380	2860	1800	200	80	2,0																	3000.60	238953		
3720	2545	2380	2860	2250	200	80																			3500.60	232851	
3720	2545	2380	2860	2500	200	80																				4000.60	232284
3750	2450	2750	3900	2000	200	80	2,6																	5000.70	168482		
3750	2450	2750	3900	2400	200	80	2,0																	6000.70	205700		
3750	2450	2750	3900	2800	200	80																				7000.70	168484
3750	2450	2750	3900	3200	200	80																				8000.70	168485

8.6 CLAMSHELL SGZ / ZWEISCHALENGREIFER SGZ

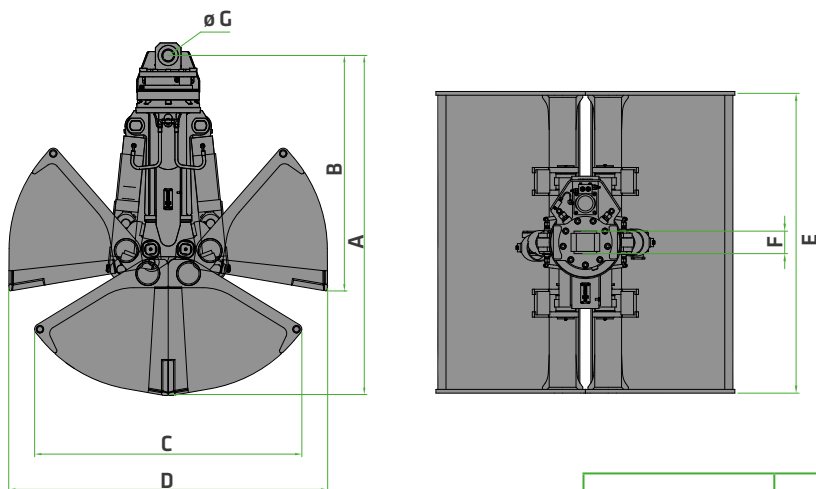

Material ² Material ²	Piled Density Schüttdichte
	t/m ³
iron ore Eisenerz	3,2
copper ore Kupfererz	2,4
manganese ore Manganerz	2,3
ton Ton	2,0
aluminium swarf Aluminiumspäne	0,1
coal Kohle	0,9
cereals, pellet Getreide, Schrot	0,7
chopped wood Hackholz	0,2
woodchips Holzschnitzel	0,3
chipped wood Holzspäne	0,5
coke Koks	0,6

HD-shell / HD-Schale
(max. 3,5 t/m³)

Light Goods Shell /
Leichtgutschale (max. 1,0 t/m³)

Type / Size Bauart / Baugröße	Rotor Drehwerk	Grab Capacity Greiferinhalt	Weight ¹ Gewicht ¹
SGZ		l	kg
1500.50-HD	DKS 26	1500	2240
2000.50-HD	DKS 26	2000	2535
2500.60-HD	DKS 35-2	2500	3350
3000.50-L	DKS 26	3000	2140
3500.50-L	DKS 26	3500	2260
4000.50-L	DKS 26	4000	2480
4500.50-L	DKS 26	4500	2600
4000.60-L	DKS 35-2	4000	2970
5000.60-L	DKS 35-2	5000	3255

8.6 CLAMSHELL SGZ / ZWEISCHALENGREIFER SGZ

The handled material affects the wear behavior of the grab in significant ways. If appropriate, please ask for our heavy duty-solutions.

Das Umschlaggut beeinflusst maßgeblich das Verschleißverhalten des Greifers.
Bitte erkundigen Sie sich ggf. nach unseren Lösungen für Schwereinsätze.

Dimensions (mm) Abmessungen (mm)							Max. piled density Max. Schüttdichte	Machine Type Maschinentyp											Type / Size Bauart / Baugröße	Order No. Bestellnummer			
A	B	C	D	E	F	G	t/m ³	817	818	821	825	830	835	840	850	855	860	870	875	880	SGZ		
2490	1720	1980	2360	1200	114	70	3,5															1500.50-HD	238754
2490	1720	1980	2360	1600	114	70																	2000.50-HD
3400	2390	2380	2860	1500	200	80	3,5															2500.60-HD	204430
2650	1750	2280	2660	2000	114	70	1,0															3000.50-L	200619
2650	1750	2280	2660	2300	114	70																	3500.50-L
2650	1750	2280	2660	2600	114	70	0,8															4000.50-L	227148
2650	1750	2280	2660	2900	114	70																	4500.50-L
3670	2515	2480	3160	2000	200	80	1,0															4000.60-L	168481
3670	2515	2480	3160	2500	200	80																	5000.60-L
Weight of Suspension / Gewicht Greiferaufhängung								67 kg			136 kg			145 kg			225 kg						

8.7 TIMBER GRAB SGH HOLZGREIFER SGH

Compact rotary drive with internal pressure protection for grab cylinders and motor

Kompakt-Drehkopf mit integrierter Maximaldruck-Absicherung für Greiferzylinder und Drehwerksmotor

Crosshead in welded construction, made of S355

Traverse in geschweißter Stahlkonstruktion aus S355

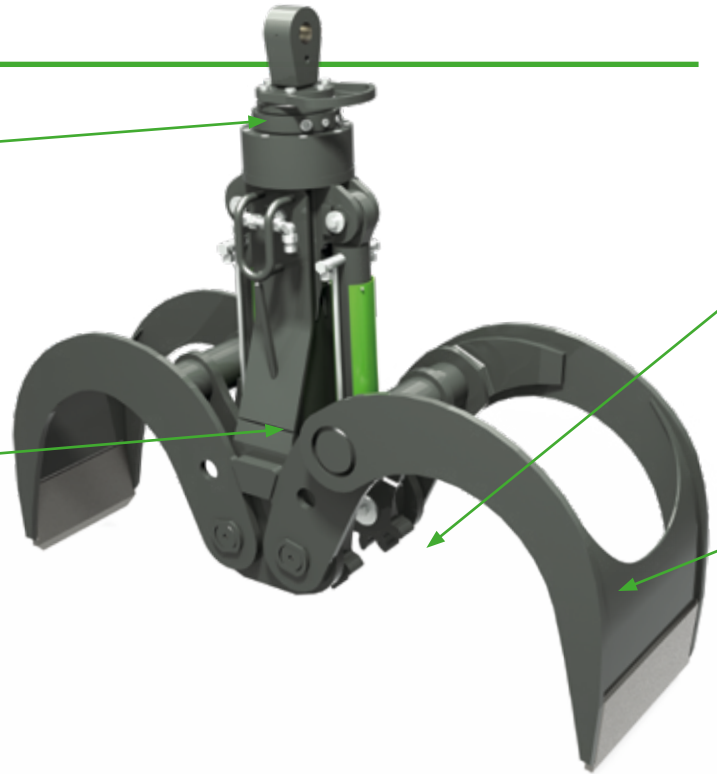

Type / Size Bauart / Baugröße	Grab Capacity Greiferinhalt	Weight ¹ Gewicht ¹	Dimensions (mm) Abmessungen (mm)									
SGH	m ²	kg	A	B	C	D	D1	d	E	E1	F	G
800.29	0,80	1165	2075	1255	150	2600	2530	1165	900	560	110	70
1000.30	1,00	1530	2815	2040	110	2510	2410	1415	800	640	110	70
1250.30	1,25	1560	2890	2055	110	2665	2555	1505	800	640	110	70
1500.30	1,50	1645	3090	2100	110	3055	2945	1625	800	640	110	70
1000.32	1,00	1765	2925	2145	110	2520	2410	1375	800	640	110	70
1250.32	1,25	1850	3025	2180	110	2670	2555	1510	800	640	110	70
1500.32	1,50	1895	3165	2220	110	2980	2850	1630	800	640	110	70
1750.32	1,75	1970	3325	2265	110	3280	3135	1695	800	620	110	70
1250.33	1,25	2290	3190	2345	110	2795	2625	1615	800	640	145	80
1500.33	1,50	2345	3275	2365	110	3030	2865	1695	800	640	145	80
1750.33	1,75	2395	3465	2410	110	3260	3080	1725	800	640	145	80
2000.33	2,00	2435	3530	2490	110	3450	3265	1805	800	640	145	80
2500.33	2,50	2580	3865	2565	110	4040	3865	1935	800	640	145	80
2500.34-K*	2,50	2540	2905	1485		4060		1900	800		145	80
3000.34-K*	3,00	2560	3180	1570		4525		2080	800		145	80
3200.34-K*	3,20	2660	3215	1585		4720		2140	800		145	80

8.7 TIMBER GRAB SGH / HOLZGREIFER SGH

Synchronization toothing for evenly distributed opening and closing, made of wear-resistant special steel (Hardox 400)

Gleichlaufverzahnung für homogenes Schließen und Öffnen, gefertigt aus verschleißfestem Sonderstahl (Hardox 400)

Round shaped clamps, welded torsion-resistant construction, made of high-tensile steel (Weldox 700)

Zangen in runder Bauform, geschweißte, verwindungssteife Stahlkonstruktion aus hochfestem Stahl (Weldox 700)

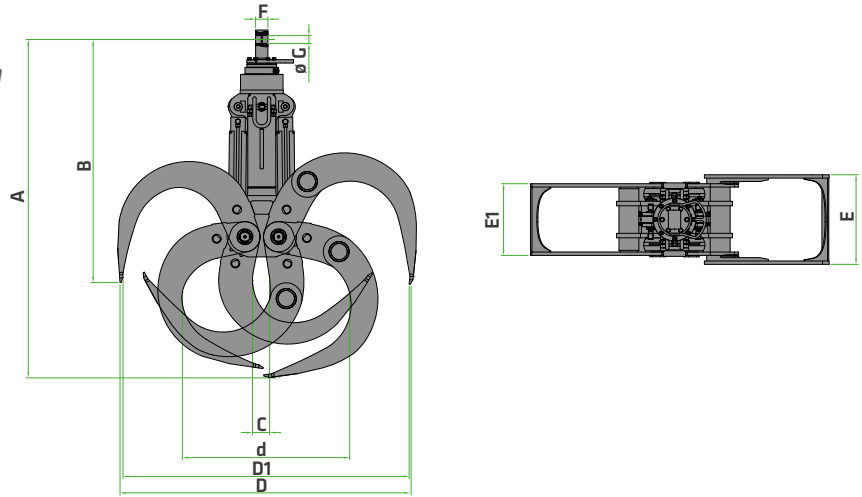

Length of Trunk Stammlänge	Machine Type Maschinentyp															Type / Size Bauart/-größe	Order No. Bestellnummer	
	m	723	730	735	817	818	821	825	830	835	840	850	855	860	870			875
6,0																	800.29	206332
5,0																	1000.30	239514
5,0																	1250.30	206789
4,0																	1500.30	236360
6,0																	1000.32	206338
6,0																	1250.32	206340
5,0																	1500.32	206342
5,0																	1750.32	206344
8,0																	1250.33	206370
8,0																	1500.33	206348
7,0																	1750.33	206372
6,0																	2000.33	206374
6,0																	2500.33	206376
6,0																	2500.34-K	206380
5,5																	3000.34-K	206378
5,0																	3200.34-K	206382
Weight of Suspension Gewicht Greifer- aufhängung	67 kg	142 kg	67 kg				142 kg				145 kg	225 kg						

8.8 SORTING GRAB SGR SORTIERGREIFER SGR

- Rotary drive with integrated mounting plates
- Pressure relief valves for rotary drive
- Four point bearing with internal teeth/pinion
- Drehwerk mit integrierter Stielaufnahme
- Druckbegrenzungsventile für Drehmotor
- Vierpunktlager mit Innenverzahnung / Ritzel

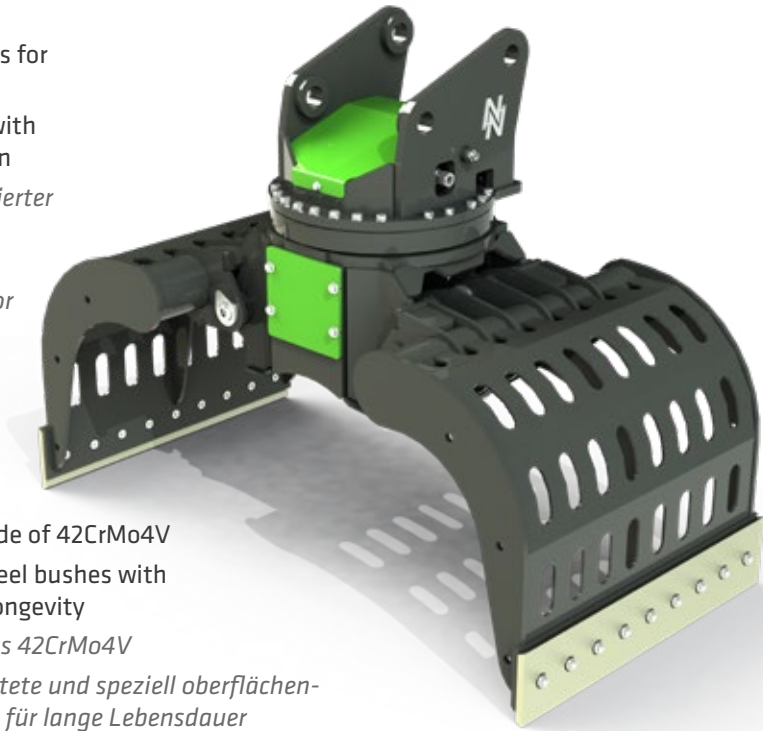

- Doubled torque motor in series
- More torque in operation
- Serienmäßig mit doppeltem Drehmotor
- Mehr Drehmoment im Einsatz
- Hydraulic cylinder with end position damping on piston base
- Hydraulikzylinder mit bodenseitiger Endlagendämpfung
- Hardened bolts, made of 42CrMo4V
- Closed, hardened steel bushes with special surface for longevity
- Gehärtete Bolzen aus 42CrMo4V
- Geschlossene, gehärtete und speziell oberflächenbehandelte Buchsen für lange Lebensdauer
- Massive end stops for both end positions
- Massive Endanschläge in beiden Endlagen der Greiferarme

- By default with perforated skin
- Minor height, lower weight
- Optional with metal ribs (additional price and weight)
- Standardmäßig mit Lochrückenwand
- Geringe Bauhöhe, niedriges Gewicht
- Optional with Siebrippen (Mehrpreis, Mehrgewicht)

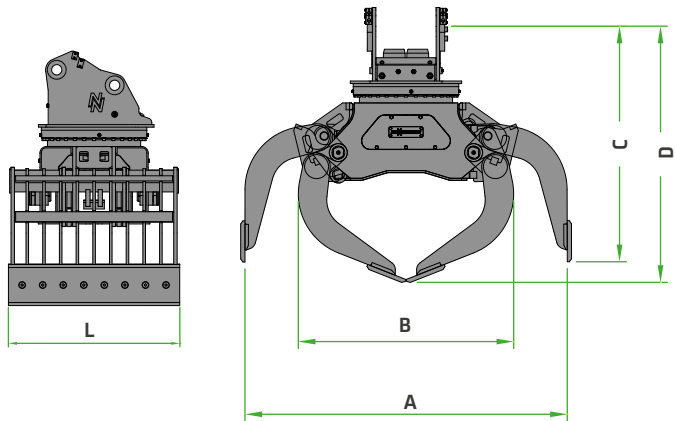

Type Typ	Capacity Inhalt	Weight Gewicht	Dimensions (mm) Abmessungen (mm)					Machine Type Maschinentyp				Type Typ	Order No. Bestellnr.
SGR	l	kg	A	B	C	D	L	817	818	821	825	SGR	
800.20-L	300	710	1550	961	1239	1386	800					800.20-L	225474
1000.20-L	500	775	1870	1010	1310	1560	1000					1000.20-L	240041
800.30-L	380	1035	1890	1160	1380	1577	840					800.30-L	226241
1000.30-L	450	1050	1890	1160	1380	1577	1000					1000.30-L	226231
1200.30-L	520	1060	1890	1160	1380	1577	1150					1200.30-L	226168
1000.35-L	650	1090	2005	1210	1440	1670	1000					1000.35-L	244872

8.9 LOADING HOOKS

LASTHAKEN



According to EU standard EN 474/5, material handling machines in lifting use have to be equipped with safety check valves at lifting cylinders and safe load indication system.

Gemäß der EU Norm EN 474/5 müssen Materialumschlaggeräte im Hebezeugbetrieb mit Rohrbruchsicherungen an Hubzylindern und einer Überlastwarneinrichtung ausgestattet sein.

Loading hook type LH

Lasthaken Typ LH

■ Free rotatable

■ Frei drehend

Type Typ	Lift Capacity Tragfähigkeit	Weight Gewicht	Height Höhe	Machine Type Maschinentyp												Order No. Bestellnr.	
				817	818	821	825	830	835	840	850	855	860	870	875		880
LH	kg	kg	mm														
LH-8	8000	45	760														199206
LH-12	12500	72	830														197740
LH-20/60	20000	156	1090														217039
LH-20/80	20000	156	1090														199199
LH-30	30000	194	1220														199049
LH-40	40000	216	1220														199200

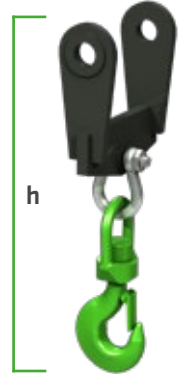

Loading hook type LH WA

Lasthaken Typ LH WA

■ Free rotatable, with quick change mounting bracket

■ Frei drehend, mit Schnellwechselfaufhängung

Type Typ	Lift Capacity Tragfähigkeit	Weight Gewicht	Height Höhe	Machine Type Maschinentyp												Order No. Bestellnr.	
				817	818	821	825	830	835	840	850	855	860	870	875		880
LH WA	kg	kg	mm														
LH-8 WA	8000	93	750														197738
LH-12 WA	12500	103	810														199198
LH-20/60 WA	20000	238	1110														257929
LH-20/80 WA	20000	233	1050														197741
LH-30 WA	30000	391	1290														257930
LH-40 WA	40000	406	1290														197743

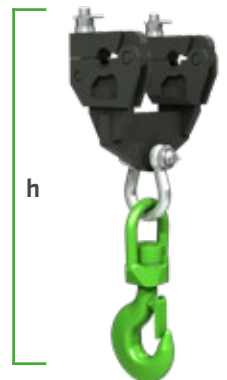

Loading hook type DKS-LH*

Lasthaken Typ DKS-LH*

■ hydraulically rotatable

■ hydraulisch drehbar

Type Typ	Lift Capacity Tragfähigkeit	Weight Gewicht	Height Höhe	Machine Type Maschinentyp												Order No. Bestellnr.	
				817	818	821	825	830	835	840	850	855	860	870	875		880
DKS-LH	kg	kg	mm														
DKS-LH-16	8000	270	640														247170
DKS-LH-26	12500	380	775														247171
DKS-LH-35	20000	550	980														234986
DKS-LH-40	30000	840	930														247172



* without grab suspension, can be ordered separately
* ohne Greiferaufhängung, separat bestellbar

8.10 SCRAP MAGNETS

SCHROTTMAGNETE

Type / Typenreihe	Power / Leistung	Dead Weight Eigengewicht	Dimensions (mm) Abmessungen (mm)			Pull-off Strength Abreißkraft	Lifting Capacity kg Tragfähigkeit kg					Machine Type Maschinentyp								Order No. Bestellnummer						
WOKO	kW	kg	ø D	L	H	kN	ingot slab Bramme	pig iron Masseln	cast iron crap Gussbruch	solid scrap Kernschrott	short chips Kurze Späne	817	818	821	825	830	835	840	850	855	860	870	875	880		
S-RLB 10	4,8	730	1000	245	~1100	190	9500	480	420	370	190															079186
S-RLB 11,5	5,5	1060	1150	270	~1100	240	12000	660	530	490	260															075352
S-RLB 12,5	8,8	1310	1250	270	~1100	280	14000	850	650	580	340															049217
S-RLB 13,5	10,0	1700	1350	300	~1100	300	15000	980	790	710	390															066927
S-RLB 15	11,7	2400	1500	300	~1100	380	19000	1340	1150	980	530															074288
S-RLB 17	17,8	3300	1700	350	~1550	640	32000	1980	1570	1470	770															090645
S-RLB 19	22,0	5090	1900	390	~1550	790	39500	2600	2100	2080	920															189642

Magnet plates Magnetplatten

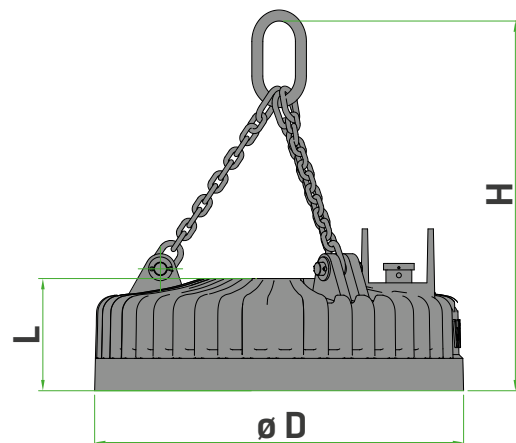

lifting magnet with 3-leg-chain
Lasthebemagnet mit 3-Strang-Kette

8.11 MAINTENANCE PACKAGES

WARTUNGSPAKETE

Maintenance packages for SENNEBOGEN grabs include all relevant wear parts replaced during regular maintenance.

Two types of maintenance packages for SENNEBOGEN grabs are available depending on operational loads.

Wartungspakete für SENNEBOGEN-Greifer beinhalten alle relevanten Verschleißteile, welche im Rahmen regelmäßiger Wartungsarbeiten ausgetauscht werden.

Entsprechend unterschiedlicher Einsatzbelastungen, sind Wartungspakete für SENNEBOGEN-Greifer in zwei Ausführungen erhältlich.

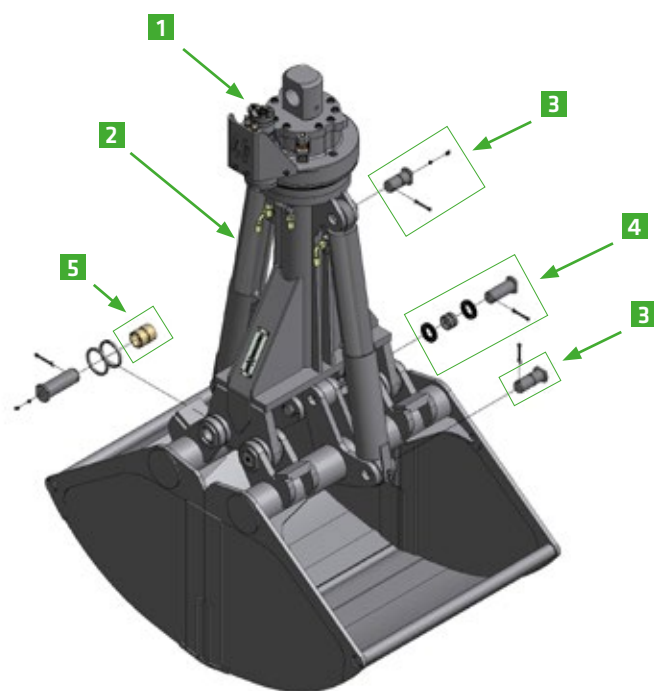
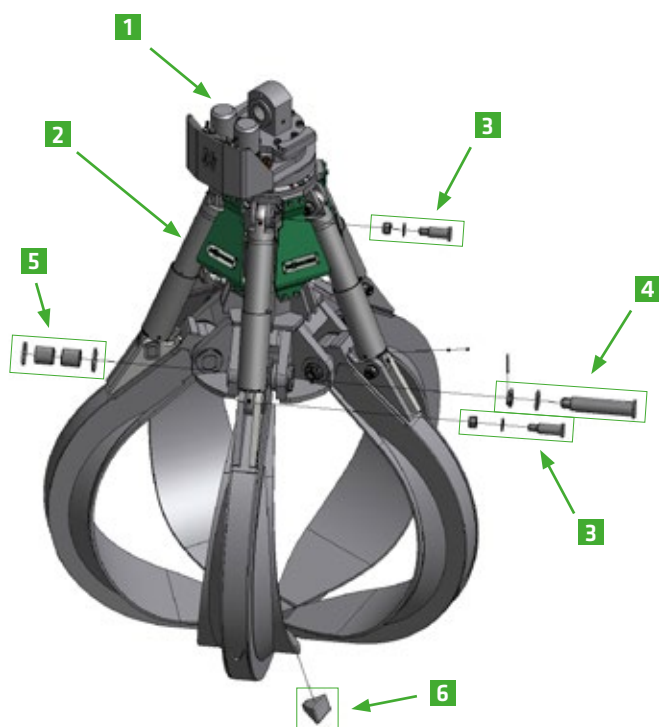

Content / Inhalt	Package 1 / Paket 1	Package 2 / Paket 2
1 seal kit rotor / Dichtsatz Drehwerk	✓	✓
2 seal kit cylinders / Dichtsatz Zylinder	✓	✓
3 cylinder bolts / Verbolzung Zylinder	✓	
4 pivot bolts / Verbolzung Schalendrehpunkt	✓	
5 bushings / Verbuchung	✓	
6 shell tips / Greiferspitzen	✓	

8.11 MAINTENANCE PACKAGES / WARTUNGSPAKETE

Your Benefits

- All wear parts in one package
- Easy requirements planning
- Easy ordering
- Easy stocking
- More efficiency
- More service
- 5 % price advantage

Ihre Vorteile

- Alle Verschleißteile in einem Paket
- Einfache Bedarfsplanung
- Einfache Bestellung
- Einfache Bevorratung
- Höhere Wirtschaftlichkeit
- Mehr Service
- 5 % Preisvorteil



Package 1 / Paket 1



Package 2 / Paket 2

Grab Type / Greifer-Typ	SN No. / Serien-Nr.	Package 1 / Paket 1	Package 2 / Paket 2
SGM.30-4	up to / bis M30138	198085	198075
	M30139 – M30351	226705	226708
	from / ab M30352	on request / auf Anfrage	on request / auf Anfrage
SGM.30-5	up to / bis M30138	198086	198074
	M30139 – M30351	226707	226709
	from / ab M30352	on request / auf Anfrage	on request / auf Anfrage
SGM.40-4		198087	198073
SGM.40-5		198088	198072
SGM.50-4		198089	198071
SGM.50-5		198090	198069
SGM.60-5 (DKS35)		198091	198068
SGM.60-5 (DKS40)		189080	198067
SGZ.40		198082	198079
SGZ.50		198083	198078
SGZ.60		198084	198077

8.12 GRAB ACCESSORIES

GREIFER ZUBEHÖR

Suspensions, bolts and hydraulic hoses for SENNEBOGEN grabs.

Aufhängungen, Bolzen und Hydraulikschläuche für SENNEBOGEN Greifer.



Grab Suspension / Greifer Aufhängung

Model Modell	Stick dimension Stielmaß (d x a)	Grab Greifer	Grab dimension Greifermaß (d x a)	Standard Mounting (incl. grab bolt) Standardaufhängung (inkl. Greiferbolzen)	Quick Change System (incl. stick and grab bolt) Schnellwechsler (inkl. Greifer- u. Stielbolzen)
817 - 855 723 - 735	60 x 350 mm	SGM.20, SGM.30, SGM.40, SGZ.20, SGZ.40, SGZ.50, SGH.30, SGH.32	70 x 115 mm	205982	205986
		SGM.50, SGH.33, SGH.34	80 x 150 mm	205983	205988
860 - 870	80 x 350 mm	SGM.60, SGZ.60	80 x 200 mm	177207	182669
		SGM.50, SGH.33, SGH.34	80 x 150 mm	205984	205990
875 - 880	100 x 500 mm	SGM.60, SGM.70, SGZ.60, SGZ.70, SGZ.80	80 x 200 mm	177209	192010

Bolts / Bolzen

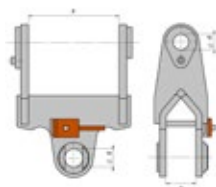

Description Bezeichnung	Dimensions Abmessungen (d x a)	Standard Mounting Standard- aufhängung	Quick Change System Schnellwechsler
stick bolt Stielbolzen	60 x 350 mm	126868	142588
	80 x 350 mm	055852	185261
	100 x 500 mm	100685	197844
grab bolt Greiferbolzen	70 x 115 mm	178107	
	80 x 150 mm	179815	
	80 x 200 mm	185262	

Hydraulic Hoses / Hydraulikschläuche



Dimensions Abmessungen	Pressure Druck	Fittings Armaturen	No. Nr.
10 x 1400 mm	330 bar	DKOL M18 x 1,5	070194
20 x 1400 mm	420 bar	DKOS M36 x 2	070195

8.13 WEAR PARTS

VERSCHLEISSTEILE

Wear Parts – Hydraulic / Verschleißteile – Hydraulik



Grab Type <i>Greifer Typ</i>	Cylinder <i>Zylinder</i>	Seal Kit <i>Dichtsatz</i>	Bearings <i>Gelenklager</i>
SGM-XXX.30	173758	173770	004909
SGM-XXX.40	169521	169606	169603
SGM-XXXX.50	178581	178575	004909
SGZ-XXXX.40	178618	178507	004909
SGZ-XXXX.50	201816	176979	010112
SGZ-XXXX.50-HD	190038	185387	010112
SGH-800.29	106524	093786	206462
SGH-1000.30 - 1250.30	094397	094398	206462
SGH-XXXX.32	088067	088069	233994
SGH-1500.33 - 2500.33	086566	206497	206496
SGH-2500.34-K - 3200.34-K	085197	253640	253639
SGR-XXXX.20-L	229632 (left side / links)	100772	229629
	229635 (right side / rechts)		
SGR-XXXX.30-L	206059 (left side / links)	160470	206388
	206392 (right side / rechts)		

8.13 WEAR PARTS / VERSCHLEISSTEILE

Wear Parts – Rotor / Verschleißteile – Drehkopf



Rotor Type <i>Rotor Typ</i>	Rotor	Seal Kit <i>Dichtsatz</i>	Bearing Kit <i>Lagersatz</i>	FD Motor <i>Konstantmotor</i>	Pressure Limitation Valve <i>Druckbegrenzungsventil</i>
DKS 16 DKS 16-2	169885	169567	169568	169543	169544
DKS 26 DKS 26-2	177003	177002	177005	176956	176932
712HC-3-G1	106530	158789	-	-	-
615 H1	074761	086077	-	-	232156
625H1/2-Ö3-SAE 1	086568	105801	-	-	232156
625H1/2-Ö3-SAE 1	096875	105801	-	-	232156
SGR.20	229670	-	-	229666	224703
SGR.30	249258	-	-	229666	224703

Shell Tips / Schalenspitzen



Grab typ <i>Greifer-Typ</i>	Dimensions (a x b) <i>Abmessungen (a x b)</i>	No. <i>Nr.</i>
SGM.30-4 SGM.40-4 SGM.50-4	190 x 105 mm	175653
SGM.30-5 SGM.40-5 SGM.50-5	140 x 105 mm	169593
SGM.60-5	210 x 160 mm	185104

8.14 GRAB MOUNTING KITS

GREIFERANBAUSÄTZE

Model Modell	Stick Stiel	Suspension Gear Aufhängung	No. Mounting Kit Nr. Anbausatz
817, 818, 821, 825	Quick Change System <i>Schnellwechsellvorrichtung</i>	ULM + SGR*	163515
817, 818, 821, 825	Ball Valves <i>Kugelhähne</i>	ULM + SGR*	246190
723, 730, 735, 817, 818, 821, 825, 830, 835, 840, 850, 855	Quick Change System <i>Schnellwechsellvorrichtung</i>	A-1, WA-1	073813
723, 730, 735, 817, 818, 821, 825, 830, 835, 840, 850, 855	Ball Valves <i>Kugelhähne</i>	A-1, WA-1	244924
723, 730, 735, 817, 818, 821, 825, 830, 835, 840, 850, 855	Quick Change System <i>Schnellwechsellvorrichtung</i>	A-2, WA-2	244922
723, 730, 735, 817, 818, 821, 825, 830, 835, 840, 850, 855	Ball Valves <i>Kugelhähne</i>	A-2, WA-2	244923
860, 870	Quick Change System <i>Schnellwechsellvorrichtung</i>	A-3, WA-3	245074
860, 870	Ball Valves <i>Kugelhähne</i>	A-3, WA-3	245075
860, 870	Quick Change System <i>Schnellwechsellvorrichtung</i>	A-4, WA-4	244922
860, 870	Ball Valves <i>Kugelhähne</i>	A-4, WA-4	244923
875, 880	Ball Valves <i>Kugelhähne</i>	A-5, WA-5	181899
875, 880	Ball Valves <i>Kugelhähne</i>	only for / nur für: SEBO-No. 182667	245076
860, 870	Quick Change System <i>Schnellwechsellvorrichtung</i>	A-7	244922
860, 870	Ball Valves <i>Kugelhähne</i>	A-7	244923
723, 730, 735, 817, 818, 821, 825, 830, 835, 840, 850, 855	Quick Change System <i>Schnellwechsellvorrichtung</i>	A-8	249095

8.15 HEAVY-DUTY ROPE SHEAVES

HEAVY-DUTY SEILROLLEN



Wear resistant for heavy-duty applications
Verschleißfest für Einsätze unter Schwerlast

- Highly wear resistant material – Ductile Cast Iron
- High strength, lubricatable bearings
- Standardized dimensions
- Versatile applicable
- *Höchst verschleißfestes Material – Duktiles Gusseisen*
- *Hochfeste, schmierbare Zylinderrollenlager*
- *Standardisierte Abmessungen*
- *Vielseitig einsetzbar*

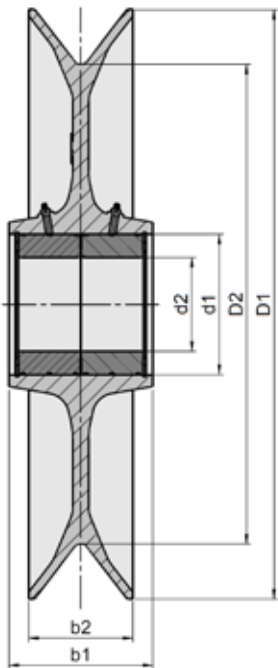

SD*	D1	D2	d1	d2	b1	b2	No.
22	600	473	180	120	104	107	188400
26	755	602	180	120	184	133	179036
28	755	602	180	120	184	133	181943
34-36	915	731	180	120	184	158	183801
42	1065	848	240	160	245	186	195939

* SD = Rope Diameter
 * SD = Seildurchmesser

8.16 STANDARD ROPE SHEAVES

STANDARD SEILROLLEN

» **Steel / welded**
Stahl / geschweißt

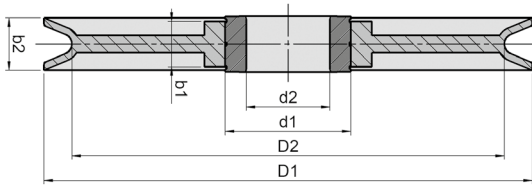

» **Polyamide**
Kunststoff

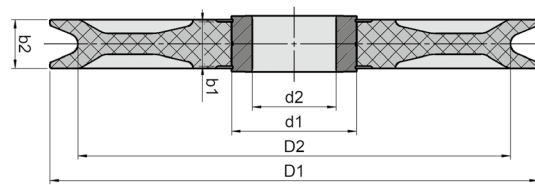

SD*	D1	D2	d1	d2	b1	b2	SB*	No.
10	130	105	26	20	30	28		001816
	150	125	26	20	30	28		004783
12	200	170	50	-	40	36		002511
	220	179	90	50	30	30		047931
	250	210	47	40	44	40		001922
	250	210	50	40	44	40		005228
13 (x3)	300	246	110	50	70	70		047932
14	130	90	68	40	48	48		152182
	255	231	50	-	40	40		132006
16	118	102	68	-	30	30		171806
	160	120	68	40	48	48		156816
	415	355	90	50	60	43		022193
	420	360	125	80	46	60		145755
18	372	352	125	80	46	46		106293
	460	400	125	80	49	53		033554
	665	500	110	80	155	130		095570
	665	540	125	80	49	92		147541
	510	440	200	140	63	61		039417
22	372	348	125	80	46	46		116967
	555	485	125	80	49	60		040097
	555	485	180	120	63	62		037009
	565	500	125	-	60	55		016364
	605	530	180	120	63	66		043696
26	109	79	55	30	50	50		146472
	158	132	90	-	40	40		184025
	655	575	180	120	63	66		037011
	655	575	180	120	63	75		131027
	655	575	180	120	66	80	●	195367
	109	84	55	30	50	50		146474
28	370	340	62	50	60	60		029623
	370	340	125	80	46	60		057423
	700	620	180	120	63	75		037012
	700	620	180	120	65	80	●	181645
	580	510	180	120	63	72		127201
34	870	765	180	120	63	80		155669
	870	765	180	120	185	85		080547
	1205	1100	180	120	210	86		112836
	188	154	68	40	35	52		172294
36	915	805	180	120	63	88	●	165269
	915	805	240	160	85	88	●	193654
42	1065	940	240	160	85	103	●	193653

SD*	D1	D2	d1	d2	b1	b2	SB*	No.
10	235	200	68	40	27	27		084600
	610	575	180	120	28	51		124038
14	345	294	110	70	40	45		155124
	365	315	120	65	52	45		029087
16	365	315	90	-	60	43		012544
	420	360	125	80	46	60		105273
	655	559	180	120	63	65		164195
	670	610	125	80	46	55		127562
	460	400	125	80	46	55		033886
18	465	400	125	70	90	56		014814
	170	98	68	40	60	60		089647
	510	440	110	90	60	60		024838
	510	440	125	80	46	60		051158
20	510	440	125	80	46	60	●	054671
	510	440	150	100	51	60		075890
	510	440	180	120	63	61	●	054668
	510	440	200	140	63	61		046968
	510	440	200	140	63	61	●	165748
	655	564	180	120	63	65	●	195816
	260	206	110	70	40	58		195483
	555	485	125	80	46	60		033885
	555	485	125	80	46	60	●	054670
	555	485	180	120	63	70		044832
26	555	485	180	120	63	70	●	200016
	700	620	180	120	63	70		078542
	158	117	60	40	50	50		134993
	260	206	110	70	40	58		131073
	615	535	180	120	63	65	●	133152
28	655	575	180	120	63	65	●	054669
	150	90	68	40	60	60		136994
	600	500	180	120	85	85		067978
	655	575	180	120	63	65	●	146471
	700	620	180	120	63	70		031364
	700	620	180	120	63	70	●	133144
34	160	90	68	40	52	66		152784
	260	206	110	70	40	75		127918
	870	765	180	120	63	85		036050

8.17 SLIDING BLOCK - REPAIR KITS

GLEITSTÜCK - REPARATURSÄTZE



Your Benefits

- All sliding blocks in one package
- Easy requirements planning
- Easy ordering
- Easy stocking
- More efficiency
- More service
- Up to 20 % price advantage

Ihre Vorteile

- Alle Gleitstücke in einem Paket
- Einfache Bedarfsplanung
- Einfache Bestellung
- Einfache Bevorratung
- Höhere Wirtschaftlichkeit
- Mehr Service
- Bis zu 20 % Preisvorteil

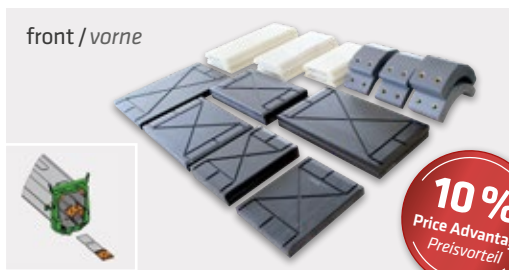

10%
Price Advantage
Preisvorteil



10%
Price Advantage
Preisvorteil



20%
Price Advantage
Preisvorteil

Model Modell	Order Number / Bestellnummer		
	Repair kit front Reparatursatz vorne	Repair kit rear Reparatursatz hinten	Repair kit complete Reparatursatz komplett
608	200947	200948	200946
613D	200965	200966	200964
613E			
643D, 653D	200950	200951	200949
HPC 35, HPC 40			
653E	200953	200954	200952
673E	200962	200963	200961
683D	200970	200971	200969
6113E	200944	200945	200943

9.1 SERVICE BOX SERVICEKOFFER



Description
Bezeichnung

No.
Nr.

Consists of high-quality, carefully selected tools and measuring devices specially designed for pressure adjustments or error diagnostics in hydraulic or electrical systems. Compiled by experienced SENNEBOGEN service technicians. Detailed summaries are listed in the appendix.

161949

Bestehend aus hochwertigen, ausgesuchten Werkzeugen und Messgeräten speziell für Druckeinstellarbeiten oder Fehlerdiagnosen an Hydraulik und Elektrik. Von erfahrenen SENNEBOGEN-Service-Technikern zusammengestellt. Detaillierte Inhaltsangaben haben wir für Sie im Anhang aufbereitet.

Premium Quality

Premiumqualität

9.2 TOOL BOX WERKZEUGKASTEN



Description
Bezeichnung

No.
Nr.

Consists of more than 60 premium quality tools, such as hammers, cordless screwdriver, grinder, torque wrenches, various different pliers, spherical head Allen keys, a hexagon socket spanner set, a socket driver set, screwdriver sets, voltage detectors, chisels, pry bars, a drift punch, an inspection lamp and a drill bit set.

057624

Bestehend aus mehr als 60 hochwertigen Qualitätswerkzeugen wie Hammer, Akku-Schlagbohrschrauber, Einhandwinkelschleifer, Drehmomentschlüssel, verschiedene Zangen, Kugelkopf-Winkelschraubendreher, Innensechskant-Schlüsselsatz, Steckschlüsselsatz, Schraubendrehersätze, Spannungsprüfer, Meißel, Nagelisen, Durchschläger, Handlampe und Bohrersatz.

10.1 AEROSOL PAINTS

SPRÜHLACKE



Description <i>Bezeichnung</i>	Content <i>Menge</i>	Color <i>Farbe</i>	No. <i>Nr.</i>
aerosol paint <i>Sprühlack</i>	400 ml	primer <i>Grundierung</i>	134379
aerosol paint <i>Sprühlack</i>	400 ml	green <i>Grün (RAL 6018)</i>	134174
aerosol paint <i>Sprühlack</i>	400 ml	grey <i>Grau (RAL 7022)</i>	104739
aerosol paint <i>Sprühlack</i>	400 ml	grey <i>Grau (RAL 7038)</i>	189989
aerosol paint <i>Sprühlack</i>	400 ml	black <i>Schwarz (RAL 9005)</i>	134175
aerosol paint <i>Sprühlack</i>	400 ml	yellow <i>Gelb (RAL 1007)</i>	134173

10.2 LACQUERS

LACKE



Description <i>Bezeichnung</i>	Content <i>Menge</i>	Color <i>Farbe</i>	No. <i>Nr.</i>
lacquer <i>Lack</i>	0,75 l	green <i>Grün (RAL 6018)</i>	040531
lacquer <i>Lack</i>	0,75 l	grey <i>Grau (RAL 7022)</i>	020181
lacquer <i>Lack</i>	0,75 l	grey <i>Grau (RAL 7038)</i>	189988
lacquer <i>Lack</i>	0,75 l	black <i>Schwarz (RAL 9005)</i>	018750
lacquer <i>Lack</i>	0,75 l	yellow <i>Gelb (RAL 1007)</i>	025868

11.1 SENNEBOGEN SVG – REBUILD, RENTAL & USED SERVICES

SENNEBOGEN SVG – REBUILD, RENTAL & USED SERVICES



The SENNEBOGEN Vertriebs GmbH & Co KG, in short Rental & Used, is your sales partner for used machines. We are Rebuyer, Refurbisher and Seller of used equipment. We use our worldwide sales channels to get the used machine back into circulation.

SENNEBOGEN Rental & Used regards itself as a partner for the rental of machines from the SENNEBOGEN product portfolio and the distribution and marketing of used machines.

With currently more than 60 available rental machines and a growing range of young used and refurbished material handlers and cranes, the company offers customers and distributors an interesting range to react quickly to project inquiries, to rent bridging machines and demonstration machines or to open up new business fields.

Short delivery times and good availability of rental machines enables the customers to avail of the necessary machines quickly and easily for a multitude of uses. Even machine applications with limited running times are carried out quickly and easily with the SENNEBOGEN Rental & Used range.

Die SENNEBOGEN Vertriebs GmbH & Co KG, kurz SVG, ist Ihr Vertriebspartner für Gebrauchsmaschinen. Wir verstehen uns als Ankäufer, Aufbereiter und Wiederverkäufer. Dabei nutzen wir unsere weltweit aufgebauten Absatzkanäle, um die Gebrauchsmaschine wieder in den Umlauf zu bekommen.

Die SVG versteht sich als Partner für die Vermietung von Maschinen aus dem SENNEBOGEN Produktportfolio und den Vertrieb und die Vermarktung von Gebrauchsmaschinen.

Mit derzeit über 60 verfügbaren Mietmaschinen und einem wachsenden Angebot an jungen Gebrauchten und generalüberholten Umschlagmaschinen und Kranen bietet die Gesellschaft Kunden und Vertriebspartnern ein interessantes Angebot, um auf Projektanfragen kurzfristig zu reagieren, Überbrückungsmaschinen und Demonstrationsgeräte anzumieten oder mit Gebrauchsmaschinen neue Geschäftsfelder zu eröffnen.

Kurzfristige Lieferzeiten und eine gute Verfügbarkeit der Mietmaschinen ermöglichen es Kunden, schnell und unkompliziert die notwendigen Maschinen für eine Vielzahl an Einsätzen verfügbar zu haben. Auch Maschineneinsätze mit begrenzten Laufzeiten sind mit dem Angebot der SENNEBOGEN Rental & Used einfach und sicher abzuwickeln.

11.1 SENNEBOGEN SVG / SENNEBOGEN SVG

SENNEBOGEN Rebuild: old becomes new *SENNEBOGEN Rebuild: aus alt wird neu*

With SENNEBOGEN Rebuild, your second-hand vehicle starts into a new machine life: Through the functional repair and the replacement of wearing parts, you can achieve a reliable and long-term function – of course only with the use of original parts. Whether you need to revise your paintwork, engine or cabin – ask us for an offer to revise your machine or find a used machine from the SENNEBOGEN Rebuild program.

Mit SENNEBOGEN Rebuild startet Ihr Gebraucher in ein neues Maschinenleben: Durch die funktionale Instandsetzung sowie das Austauschen von Verschleißteilen können Sie eine zuverlässige und langfristige Funktion erreichen – selbstverständlich nur unter Verwendung von Originalteilen. Ob Überarbeitung von Lackierung, Motor oder Kabine – fragen Sie bei uns an und lassen Sie sich ein Angebot für eine Überarbeitung Ihrer Maschine erstellen oder finden Sie eine Gebrauchmaschine aus dem SENNEBOGEN Rebuild Programm.

Before / Vorher



After / Nachher



12.1 TRAINING

TRAININGSANGEBOTE

Knowledge on the fast track –
our technical training for owners

Innovative technology is only effective if it is used appropriately by a trained operator.

Only those who have perfectly mastered their tools can work effectively and safely. This is why cost-effective use depends greatly on the training, experience and expertise of machine owners and technicians. A comprehensive technical knowledge helps to analyze many problems independently, prevent damage and perform maintenance and repairs properly.

We're happy to share our knowledge with you: for your success and the satisfaction of our customers!

Your Benefits

» Best Possible Machine Availability

The more comprehensive the knowledge of your staff, the less damage occurs due to operator error and therefore resulting in less downtime.

» Increased Efficiency

Your workers can identify many technical problems themselves to ensure smooth operations. Fuel-saving and careful driving can lower costs.

» More Safety on the Job

Participants become familiar with all relevant accident prevention regulations and learn how to comply with all legal and employers' liability insurance association regulations.

» Extended Service Life

Better maintenance, optimal detection and prevention of unnecessary service and repair.

Wissen auf der Überholspur –
unser Technisches Training für Betreiber

Was nutzt innovativste Technik, wenn man nicht optimal damit umgehen kann?

Nur wer sein Arbeitsgerät perfekt beherrscht, kann auch effektiv und sicher arbeiten. Der kosteneffiziente Einsatz hängt deshalb stark von der Ausbildung, der Erfahrung und dem Know-how der Maschinenbediener und Techniker ab. Umfangreiche technische Kenntnisse helfen dabei, viele Probleme selbst zu analysieren, Beschädigungen zu vermeiden und fachgerechte Reparaturen und Wartungsarbeiten durchzuführen.

Wir teilen gerne unser Wissen mit Ihnen: Für Ihren Erfolg und die Zufriedenheit unserer Kunden!

Ihr Nutzen

» Bestmögliche Maschinenverfügbarkeit

Umfassendere Kenntnisse der Mitarbeiter bewirken ein verringertes Schadensaufkommen durch Bedienungsfehler und minimale Ausfallzeiten.

» Effizienzsteigerung

Ihre Mitarbeiter können viele technische Probleme selbstständig identifizieren und sorgen so für reibungslose Arbeitsabläufe. Durch material-schonendes und spritsparendes Fahren können Kosten gesenkt werden.

» Mehr Sicherheit im Betrieb

Die Teilnehmer werden geschult, um mit allen relevanten Unfallverhütungsvorschriften vertraut zu sein und alle rechtlichen und berufsgenossenschaftlichen Vorschriften einzuhalten.

» Längere Lebensdauer

Bessere Wartung, optimales Erkennen und Verhindern von Service-Situationen.

12.2 OPERATOR TRAINING BEDIENERSCHULUNGEN

We are aware of your responsibility to your employees. That's why our highly practical training gives machine operators what they need to operate the system independently and responsibly, as well as to recognize and correct minor malfunctions themselves. The training has been designed to be flexible and give plenty of leeway for meeting individual needs.

Participants will learn how to operate the machine and how it works, how to perform routine maintenance and cleaning, and receive tips for operating the machine with as few disruptions as possible.

Ihre Verantwortung für Ihre Mitarbeiter ist uns bewusst. Deshalb werden bei der sehr praxisorientierten Schulung Maschinenbediener in die Lage versetzt, selbstständig und verantwortungsvoll die Anlage zu bedienen sowie kleinere Störungen zu erkennen und eigenständig zu beseitigen. Das Schulungskonzept ist flexibel konzipiert und lässt Spielraum für individuelle Bedürfnisse.

Die Teilnehmer werden mit der Bedienung und den Funktionsweisen der Maschine vertraut, lernen, wie tägliche Wartungs- und Reinigungsarbeiten durchzuführen sind und erhalten Tipps für einen möglichst störungsfreien Betrieb der Maschine.

Highlights

- Theoretical and practical training
- Routine visual inspections and function checks, and much more
- Efficient machine control
- Training as an experience
- Certificate of participation
- Inclusive catering
- Ausbildung in Theorie und Praxis
- Arbeitstägliche Sicht- und Funktionskontrollen uvm.
- Effiziente Maschinenbedienung
- Training als Erlebnis-Event
- Teilnehmerzertifikat
- Inklusive Verpflegung

Contents / Inhalte

Correctly interpreting error messages and taking the necessary measures. Explanation of sub-assemblies and definitions of terms, machine engineering, safety regulations, using attachments incl. training maneuvers

Fehlermeldungen richtig interpretieren und notwendige Maßnahmen ergreifen, Baugruppen und Begriffsbestimmungen, Maschinentechnik, Sicherheitsbestimmungen, Einsatz von Anbaugeräten inkl. Fahrübungen

For / Zielgruppe

Employees responsible for the operation of the machine. For new machines, this training should take place before startup.

Mitarbeiter, die für die Bedienung verantwortlich sind. Bei Neumaschinen sollte diese Schulung idealerweise vor Inbetriebnahme erfolgen.

Duration / Dauer

1,5 days / 1,5 Tage



12.3 TECHNICAL TRAINING FOR CUSTOMERS

TECHNISCHES TRAINING FÜR ENDKUNDEN

Participants gain an overview of the machines and become familiar with where the components are and how they function.

They will learn about operation and maintenance, and how the primary components work. They will gain an understanding on how the system works from the hydraulic/electrical circuit diagram and be able to troubleshoot issues. **With the right mix of theoretical expertise and practical exercises, we show you how to extend service life, maximize efficiency and safely operate the machine.**

Die Teilnehmer bekommen einen Überblick über die Maschinen und lernen die Lage der Bauteile und deren Funktion kennen.

*Sie werden mit der Bedienung und Wartung vertraut gemacht und lernen die Arbeitsweisen der Hauptkomponenten kennen. Sie lernen, die Ansteuerung auf dem Hydraulik- bzw. Elektroschaltplan nachzuvollziehen und werden in die Lage versetzt, Fehlersuchen selbständig durchzuführen. **Mit dem richtigen Mix aus theoretischem Fachwissen und praktischen Übungen zeigen wir, wie hohe Laufleistungen, eine maximale Effizienz und eine sichere Bedienung der Maschine erreicht werden können.***

Contents / Inhalte

Tools and equipment, servicing and maintaining the machine, working with hydraulic and electrical circuit diagrams, pressure control, troubleshooting, working efficiently with the machines, adding attachments

Gerätekunde, Service und Wartung der Maschine, Arbeiten mit Hydraulik- und Elektroschaltplan, Druckkontrolle, Fehlersuche, ökonomische Arbeitsweise mit den Maschinen, Anbau von Arbeitsgeräten

For / Zielgruppe

Operators and workshop personnel responsible for operating and repairing the machine.

Fahrer und Werkstattpersonal, die mit der Bedienung und Reparatur der Maschine beauftragt sind.

Duration / Dauer

2,5 days / 2,5 Tage



Highlights

- Professionals training your employees
- Increased machine availability
- Modern teaching and learning materials
- Up-to-date industry expertise
- Test, training certificate
- Inclusive catering
- Profis, die Ihre Mitarbeiter trainieren
- Erhöhte Maschinenverfügbarkeit
- Moderne Lehr- und Lernmittel
- Aktuelles Branchen-Know-how
- Lernerfolgskontrolle, Trainingszertifikat
- Inklusive Verpflegung

12.4 OPERATOR LICENCES FAHRAUSWEISE

The employers' liability insurance associations and the Ordinance on Industrial Safety and Health state that material handling machines and cranes may only be operated by trained and certified personnel.

During two day theoretical and practical seminars, we teach you how to competently and safely operate and perform maintenance on the machines.

Participants who pass the theory and partial final test, will receive an operator's licence and the status "trained person".

Die Berufsgenossenschaften und die Betriebssicherheitsverordnung schreiben vor, dass nur ausgebildete und geprüfte Personen zum Fahren und Bedienen von Umschlagmaschinen und Kränen beauftragt werden dürfen.

Wir unterweisen Sie in einem 2-tägigen Theorie- und Praxis-Seminar in der fachkundigen und sicheren Bedienung und Wartung von Umschlagmaschinen und Kränen.

Durch das Ablegen einer abschließenden Prüfung in Theorie und Praxis erhalten die Teilnehmer einen Fahrausweis und den Status „unterwiesene Person“.

Contents / Inhalte

Legal bases, definitions, Hazard analysis, practical Briefing incl. driving practice, Secure, Maintain and maintenance of the machine

Rechtliche Grundlagen, Begriffsbestimmungen, Gefahrenanalyse, praktische Einweisung inkl. Fahrübung, Sichern, Pflegen und Wartung der Maschine

For / Zielgruppe

Machine operators to increase the efficiency every day. Everyone who would like to acquire the status "trained person".

Personen, die Maschinen bedienen und hierfür Tipps und Techniken erhalten möchten, um die Effizienz Tag für Tag zu steigern. Jeder, der den Status „unterwiesene Person“ erwerben möchte.

Duration / Dauer

2 days / 2 Tage

Highlights

- Obtaining an operator licence
- Practical tests at a demonstration site
- Insider expertise
- Modern teaching and learning materials
- Operator confidence
- Inclusive catering
- Erwerb: Fahrausweis
- Praxistests Vorführgelände
- Know-how aus erster Hand
- Moderne Lehr- und Lernmittel
- Handlungssicherheit für Fahrer
- Inklusive Verpflegung

Additional Training / Weitere Trainingsangebote:
www.SENNEBOGEN-ACADEMY.com



13.1 SENNEBOGEN CUSTOMER SERVICE CENTER SENNEBOGEN CUSTOMER SERVICE CENTER



By 2021 a new centre for after sales, customer service and the subsidiary Rental & Used will be built just outside Straubing.

Bis 2021 entsteht vor den Toren Straubings ein neues Zentrum für After Sales, Kundendienst und die Tochter Rental & Used.

13.1 SENNEBOGEN CUSTOMER SERVICE CENTER

SENNEBOGEN CUSTOMER SERVICE CENTER



We continue to grow ...

We are continuing to develop our growth and service strategy with a new Customer Service Center. On Straubing's doorstep, we will bundle our international spare parts business in the future, invest in warehouse automation and optimize our logistics processes.

At the same time, there are on a building area of 22,000 m² also the customer service and our local sales and rental company are at home. They will help you as a dealer and customer with the best possible support in all matters.

Wir wachsen weiter ...

Mit einem neuen Customer Service Center entwickeln wir unsere Wachstums- und Servicestrategie weiter. Vor den Toren Straubings bündeln wir zukünftig das internationale Ersatzteilwesen, investieren in eine Automation der Lagertechnik und optimieren unsere Logistikprozesse.

Gleichzeitig sind dort auf einer Gebäudefläche von 22.000 m² auch der Kundendienst und unsere Vertriebsgesellschaft zuhause, um Sie als Händler und Kunde in allen Belangen bestmöglichst zu unterstützen.

» Our picture shows the architectural design:

Two office buildings and spacious halls for customer service and a state-of-the-art spare parts warehouse are being built directly along the A3 motorway on 87,000 m² of land.

» Unser Bild zeigt den Architektenentwurf:

Direkt an der Autobahn A3 entstehen auf 87.000 m² Grundstücksfläche zwei Bürogebäude und großzügige Hallen für Kundendienst und ein hochmodernes Ersatzteillager.

13.2 DEALER INFORMATION CENTER DEALER INFORMATION CENTER

Benefits for SENNEBOGEN dealers

- Spare parts availability retrievable worldwide
- Information about current special offers
- Automated order acceptance
- Order archives accessible at any time
- Service cost calculator online
- Machine documentation retrievable worldwide
- Current service news and training course offers

Vorteile für SENNEBOGEN-Händler

- Verfügbarkeit von Ersatzteilen weltweit abrufbar
- Informationen zu aktuellen Sonderaktionen
- Automatisierte Auftragsannahme
- Auftragsarchiv jederzeit abrufbar
- Servicekosten-Rechner online
- Maschinendokumentationen weltweit abrufbar
- Aktuelle Service-News und Schulungsangebote

D.I.C. home
Startseite



spare parts catalogue
Ersatzteilkatalog



spare parts shop
Ersatzteilbestellungen



service news
Service-News

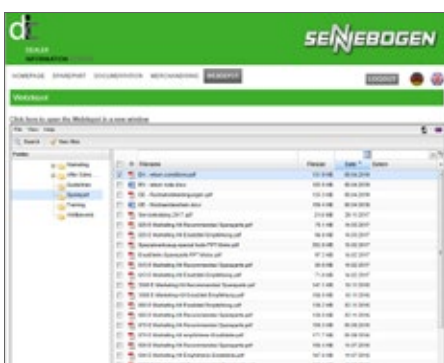

warranty claims
Gewährleistungsabwicklung



merchandising shop
Werbeartikelbestellungen

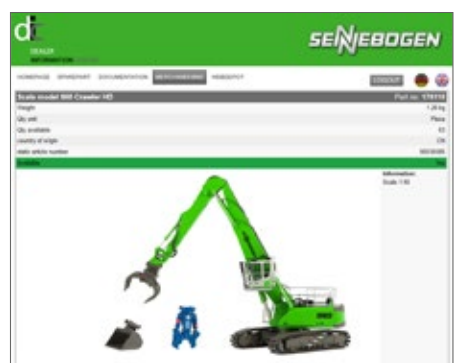

Login for SENNEBOGEN dealers

www.DIC.SENNEBOGEN.de

Login für SENNEBOGEN-Händler

www.DIC.SENNEBOGEN.de



13.3

PARTS CATALOG ONLINE ETK-ONLINE

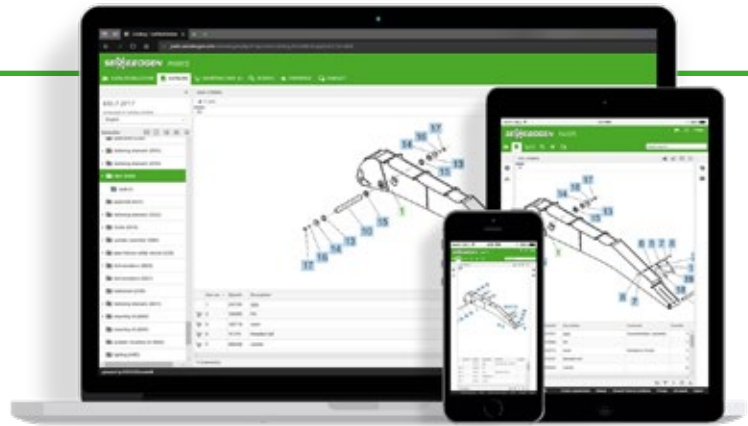

Catalog database

- First-hand machine documentation
- Up-to-date data
- Spare parts catalogs: all parts, parts lists and drawings of the machine are linked and available online

Machinery

- Individual favorites list for machines
- Easy tracking options
- Acquisition of individual information per machine

Shopping cart features

- Order parts and inquire directly in the catalog
- Shopping cart history for recurring demands

User friendliness

- Multifunctional search function
- Modules in favorite list
- Eight languages



Access for dealers

via D.I.C. [Documentation » Parts Online]



Access for machine operators

via parts.sennebogen.com

Katalog-Datenbank

- *Maschinen-Dokumentation aus erster Hand*
- *Tagesaktuelle Daten*
- *Ersatzteilkataloge: alle Teile, Stücklisten und Zeichnungen der Maschine sind verknüpft und online abrufbar*

Maschinenpark

- *Individuelle Favoritenliste für Maschinen*
- *Einfache Tracking Möglichkeiten*
- *Erfassung individueller Informationen je Maschine*

Warenkorb Funktionen

- *Teile bestellen und anfragen direkt im Katalog*
- *Warenkorb-Historie für wiederkehrende Bedarfe*

Benutzerfreundlichkeit

- *Multifunktionale Suchfunktion*
- *Baugruppen in Favoritenliste*
- *Acht Sprachen*

Zugang für Händler

via D.I.C. [Dokumentation » ETK-Online]

Zugang für Maschinenbetreiber

via parts.sennebogen.com



13.4

EXTENDED WARRANTY

ERWEITERTE GEWÄHRLEISTUNG

So that the end customer can enjoy SENNEBOGEN machines even after the manufacturer's warranty has expired, we offer in addition to the standard warranty the possibility to purchase individual warranty extensions after the machine has been purchased.

Damit der Endkunde auch nach Ablauf der Herstellergarantie viel Freude an unseren SENNEBOGEN Maschinen hat, bieten wir über die Standardgewährleistung hinaus die Möglichkeit an, dass individuelle Erweiterungen der Gewährleistung nach Kauf der Maschine nachträglich abgeschlossen werden können.

Benefits

- Longer end customer loyalty
- More security for the end customer
- Protection and security against unexpected costs
- More accurate operating cost calculation
- Contract conclusion is possible at any time within the standard warranty
- Increase resale value
- Optimal customizable packages
- Increase machine availability through regular maintenance

Requirement

- SENtrack is installed (retrofitting possible)
- The machine is still within the standard warranty (12 months or 2,000 hours)
- Installation of the Hydroclean filter if technically possible
- Regular oil analysis, hydraulic oil from 2,000 hours (with proof as described in the operating and maintenance instructions)
- Service by authorized SENNEBOGEN partner
- Regular examination of the steel structure with proof (Steel Structure Check List)

Vorteile

- *Längere Endkundenbindung*
- *Mehr Sicherheit für den Endkunden*
- *Schutz und Sicherheit vor unerwarteten Kosten*
- *Genauere Betriebskostenkalkulation*
- *Vertragsabschluss ist jederzeit innerhalb der Standard Gewährleistung möglich*
- *Steigerung des Wiederverkaufswertes*
- *Optimale individuell anpassbare Pakete*
- *Steigerung der Maschinenverfügbarkeit durch regelmäßige Wartung*

Voraussetzungen

- *SENtrack ist verbaut (nachträglicher Einbau möglich)*
- *Maschine befindet sich noch innerhalb der Standardgewährleistung (12 Monate oder 2.000 Betriebsstunden)*
- *Einbau des Hydroclean Filters soweit technisch möglich*
- *Regelmäßige Ölanalyse, Hydrauliköl ab 2.000 Betriebsstunden (mit Nachweis, wie in Bedienungs- und Wartungsanleitung beschrieben)*
- *Service durch autorisierten SENNEBOGEN-Partner*
- *Regelmäßige Überprüfung des Stahlbaus mit Nachweis*

13.4 EXTENDED WARRANTY ERWEITERTE GEWÄHRLEISTUNG

Our offers for you

Unser Angebot

BRONZE PACKAGE	<p>Limited Components Warranty</p> <p>» Covers: Parts</p>	<p><i>Eingeschränkte Komponentengewährleistung</i></p> <p>» <i>Beinhaltet: Teile</i></p>
SILVER PACKAGE	<p>Components Warranty</p> <p>» Covers: Parts and labour costs (diesel engine and electric motor available on request)</p>	<p><i>Komponentengewährleistung</i></p> <p>» <i>Beinhaltet: Teile und Arbeitskosten (Dieselmotor und Elektromotor auf Anfrage)</i></p>
GOLD PACKAGE	<p>Parts Warranty</p> <p>» Covers: Parts, freight costs, customs duties & import levies, diesel engine and electric motor</p>	<p><i>Teilegewährleistung</i></p> <p>» <i>Beinhaltet: Teile, Frachtkosten, Zoll/Importsteuer, Dieselmotor und Elektromotor</i></p>
PLATINUM PACKAGE	<p>Full Warranty</p> <p>» Covers: Parts, freight costs, customs duties & import levies, labour costs, travel costs, diesel engine and electric motor</p>	<p><i>Vollgewährleistung</i></p> <p>» <i>Beinhaltet: Teile, Frachtkosten, Zoll/Importsteuer, Arbeitskosten, Fahrtkosten, Dieselmotor und Elektromotor</i></p>

Type Art	Validity Gültigkeit	Programme Programm	Parts Teile	Freight costs Frachtkosten	Customs duties & Import levies Zoll / Importsteuer	Labour costs Arbeitskosten	Travel costs Fahrtkosten	Diesel engine Dieselmotor	Attachments Anbaugeräte
Basic Warranty Grund-Gewährleistung	1st – 12th month (max. 2000 service hours) 1. – 12. Monat (jedoch max. 2000 B-Std.)	Parts Warranty Teilegewährleistung	✓	✓	✓	-	-	✓	✓
		Full Warranty Vollgewährleistung	✓	✓	✓	✓	✓	✓	✓
Extended Warranty Erweiterte Gewährleistung	from 13th month (or 2001 service hours to the end of agreed period/service hours) ab 13. Monat (bzw. 2001 B-Std. bis vereinbarte Zeit/Betriebsstundenanzahl)	BRONZE PACKAGE	✓	-	-	-	-	-	-
		SILVER PACKAGE	✓	-	-	✓	-	Available at an extra charge Gegen Aufpreis möglich	-
		GOLD PACKAGE	✓	✓	✓	-	-	✓	-
		PLATINUM PACKAGE	✓	✓	✓	✓	✓	✓	-
Spare parts Warranty Ersatzteil-Gewährleistung	from installation ab Einbau	Orig. SENNEBOGEN-parts Orig. SENNEBOGEN-Teile	✓	✓	-	-	-	-	-
		Orig. SENNEBOGEN-refurbished-parts Orig. SENNEBOGEN-Austauschteile	✓	✓	-	-	-	-	-

14.1 SERVICE PACKAGES (250 H)

SERVICE-PAKETE (250 H)

Description / Bezeichnung	Qty. / St.	No. / Nr.
245654 service package (250 h) / Service-Paket (250 h) 355E (FPT N45 Tier 4f, VF)		
return flow filter Rücklauffilter	1	228568
leakage oil filter Leckölfiter	1	063580
ventilation filter Belüftungsfilter	1	236336
auxiliary control filter Vorsteuerfilter	1	228567
breather filter Entlüftungsfilter	1	168306
engine oil filter Motorölfilter	1	206076
fuel filter Kraftstofffilter	1	103142
filter water separator Filter Wasserabscheider	1	176434
227804 service package (250 h) / Service-Paket (250 h) 718E (QSB 4.5 Tier 4f / IV, VF)		
auxiliary control filter Vorsteuerfilter	1	150308
return flow filter Rücklauffilter	1	151945
leakage oil filter Leckölfiter	1	027376
line filter Speisedruckfilter	1	154947
227805 service package (250 h) / Service-Paket (250 h) 718E (QSB 4.5 Tier 4f / IV, HC)		
HydroClean HydroClean	1	150309
return flow filter Rücklauffilter	1	151945
leakage oil filter Leckölfiter	1	027376
line filter Speisedruckfilter	1	154947
231014 service package (250 h) / Service-Paket (250 h) 723E (QSB 4.5 Tier 4f / IV, VF)		
return flow filter Rücklauffilter	1	150307
leakage oil filter Leckölfiter	1	027376
auxiliary control filter Vorsteuerfilter	1	150308
line filter Speisedruckfilter	1	154947
224400 service package (250 h) / Service-Paket (250 h) 723E (QSB 4.5 Tier 4f / IV, HC)		
return flow filter Rücklauffilter	1	150307
leakage oil filter Leckölfiter	1	027376
HydroClean HydroClean	1	150309
line filter Speisedruckfilter	1	154947
231017 service package (250 h) / Service-Paket (250 h) 730E, 735E (QSB 6.7 QSL 9 Tier 4f / IV, VF)		
return flow filter Rücklauffilter	2	150307
leakage oil filter Leckölfiter	1	027376
auxiliary control filter Vorsteuerfilter	1	150308
line filter Speisedruckfilter	1	154947
224542 service package (250 h) / Service-Paket (250 h) 730E, 735E (QSB 6.7 QSL 9 Tier 4f / IV, HC)		
return flow filter Rücklauffilter	2	150307
leakage oil filter Leckölfiter	1	027376

Description / Bezeichnung	Qty. / St.	No. / Nr.
HydroClean HydroClean	1	150309
line filter Speisedruckfilter	1	154947
254316 service package (250 h) / Service-Paket (250 h) 735E (QSL 9 Tier 3a, VF)		
ventilation filter Belüftungsfilter	1	153955
auxiliary control filter Vorsteuerfilter	1	150308
leakage oil filter Leckölfiter	1	027376
line filter Speisedruckfilter	1	154947
return flow filter Rücklauffilter	2	150307
breather filter Entlüftungsfilter	1	168306
254317 service package (250 h) / Service-Paket (250 h) 735E (QSL 9 Tier 3a, HC)		
ventilation filter Belüftungsfilter	1	153955
HydroClean HydroClean	1	150309
leakage oil filter Leckölfiter	1	027376
line filter Speisedruckfilter	1	154947
return flow filter Rücklauffilter	2	150307
breather filter Entlüftungsfilter	1	168306
253212 service package (250 h) / Service-Paket (250 h) 735E (L9 EU Stage V, VF)		
return flow filter Rücklauffilter	2	150307
leakage oil filter Leckölfiter	1	027376
ventilation filter Belüftungsfilter	1	153955
auxiliary control filter Vorsteuerfilter	1	150308
breather filter Entlüftungsfilter	1	168306
line filter Speisedruckfilter	1	154947
253213 service package (250 h) / Service-Paket (250 h) 735E (L9 EU Stage V, HC)		
return flow filter Rücklauffilter	2	150307
leakage oil filter Leckölfiter	1	027376
ventilation filter Belüftungsfilter	1	153955
HydroClean HydroClean	1	150309
breather filter Entlüftungsfilter	1	168306
line filter Speisedruckfilter	1	154947
238770 service package (250 h) / Service-Paket (250 h) 817E (FPT N45 Tier 4f, VF)		
return flow filter Rücklauffilter	1	150307
leakage oil filter Leckölfiter	1	027376
line filter Speisedruckfilter	1	154947
breather filter Entlüftungsfilter	1	168306
auxiliary control filter Vorsteuerfilter	1	150308

Description / Bezeichnung	Qty. / St.	No. / Nr.
238771 service package (250 h) / Service-Paket (250 h) 817E (FPT N45 Tier 4f, HC)		
return flow filter Rücklauffilter	1	150307
leakage oil filter Leckölfiter	1	027376
line filter Speisedruckfilter	1	154947
breather filter Entlüftungsfilter	1	168306
HydroClean HydroClean	1	150309
164548 service package (250 h) / Service-Paket (250 h) 818D, 821C (QSB 4.5 Tier 3 / IIIA, VF)		
return flow filter Rücklauffilter	1	150307
leakage oil filter Leckölfiter	1	027376
auxiliary control filter Vorsteuerfilter	1	150308
164549 service package (250 h) / Service-Paket (250 h) 818D, 821C (QSB 4.5 Tier 3 / IIIA, HC)		
return flow filter Rücklauffilter	1	150307
leakage oil filter Leckölfiter	1	027376
HydroClean HydroClean	1	150309
180832 service package (250 h) / Service-Paket (250 h) 818E, 821E (QSB 4.5, VF)		
return flow filter Rücklauffilter	1	150307
leakage oil filter Leckölfiter	1	027376
auxiliary control filter Vorsteuerfilter	1	150308
line filter Speisedruckfilter	1	154947
180833 service package (250 h) / Service-Paket (250 h) 818E, 821E (QSB 4.5, HC)		
return flow filter Rücklauffilter	1	150307
leakage oil filter Leckölfiter	1	027376
HydroClean HydroClean	1	150309
line filter Speisedruckfilter	1	154947
164550 service package (250 h) / Service-Paket (250 h) 825D - 840D (QSB 6.7 Tier 3 / IIIA, VF)		
return flow filter Rücklauffilter	2	150307
leakage oil filter Leckölfiter	1	027376
auxiliary control filter Vorsteuerfilter	1	150308
164551 service package (250 h) / Service-Paket (250 h) 825D - 840D (QSB 6.7 Tier 3 / IIIA, HC)		
return flow filter Rücklauffilter	2	150307
leakage oil filter Leckölfiter	1	027376
HydroClean HydroClean	1	150309
180836 service package (250 h) / Service-Paket (250 h) 825E, 830E (QSB 6.7, VF)		
return flow filter Rücklauffilter	2	150307
leakage oil filter Leckölfiter	1	027376
auxiliary control filter Vorsteuerfilter	1	150308
line filter Speisedruckfilter	1	154947

14.1 SERVICE PACKAGES (250 H) / SERVICE-PAKETE (250 H)

Description / Bezeichnung	Qty. / St.	No. / Nr.
180837 service package (250 h) / Service-Paket (250 h) 825E, 830E (QSB 6.7, HC)		
return flow filter Rücklauffilter	2	150307
leakage oil filter Leckölfiter	1	027376
HydroClean HydroClean	1	150309
line filter Speisedruckfilter	1	154947
247949 service package (250 h) / Service-Paket (250 h) 825E, 830E (B 6.7 EU Stage V, VF)		
return flow filter Rücklauffilter	2	150307
leakage oil filter Leckölfiter	1	027376
ventilation filter Belüftungsfilter	1	153955
auxiliary control filter Vorsteuerfilter	1	150308
breather filter Entlüftungsfilter	1	168306
engine oil filter Motorölfiter	1	106924
fuel filter Kraftstofffilter	1	169951
filter water separator Filter Wasserabscheider	1	176434
line filter Speisedruckfilter	1	154947
247948 service package (250 h) / Service-Paket (250 h) 825E, 830E (B 6.7 EU Stage V, HC)		
return flow filter Rücklauffilter	2	150307
leakage oil filter Leckölfiter	1	027376
ventilation filter Belüftungsfilter	1	153955
HydroClean HydroClean	1	150309
breather filter Entlüftungsfilter	1	168306
engine oil filter Motorölfiter	1	106924
fuel filter Kraftstofffilter	1	169951
filter water separator Filter Wasserabscheider	1	176434
line filter Speisedruckfilter	1	154947
252382 service package (250 h) / Service-Paket (250 h) 835E (QSL9 Tier 3 / IIIA, VF)		
auxiliary control filter Vorsteuerfilter	1	150308
return flow filter Rücklauffilter	1	151945
leakage oil filter Leckölfiter	1	027376
breather filter Entlüftungsfilter	1	168306
ventilation filter Belüftungsfilter	1	153955
line filter Speisedruckfilter	1	154947
252383 service package (250 h) / Service-Paket (250 h) 835E (QSL9 Tier 3 / IIIA, HC)		
HydroClean HydroClean	1	150309
return flow filter Rücklauffilter	1	151945
leakage oil filter Leckölfiter	1	027376
breather filter Entlüftungsfilter	1	168306

Description / Bezeichnung	Qty. / St.	No. / Nr.
ventilation filter Belüftungsfilter	1	153955
line filter Speisedruckfilter	1	154947
180839 service package (250 h) / Service-Paket (250 h) 835E, 840E (QSL 9 Tier 4i / IIIB, VF)		
auxiliary control filter Vorsteuerfilter	1	150308
line filter Speisedruckfilter	1	154947
return flow filter Rücklauffilter	1	151945
leakage oil filter Leckölfiter	1	027376
180840 service package (250 h) / Service-Paket (250 h) 835E, 840E (QSL 9 Tier 4i / IIIB, HC)		
HydroClean HydroClean	1	150309
line filter Speisedruckfilter	1	154947
return flow filter Rücklauffilter	1	151945
leakage oil filter Leckölfiter	1	027376
187495 service package (250 h) / Service-Paket (250 h) 835E, 840E (QSL 9 Tier 4f / IV, VF)		
auxiliary control filter Vorsteuerfilter	1	150308
line filter Speisedruckfilter	1	154947
return flow filter Rücklauffilter	1	151945
leakage oil filter Leckölfiter	1	027376
187496 service package (250 h) / Service-Paket (250 h) 835E, 840E (QSL 9 Tier 4f / IV, HC)		
HydroClean HydroClean	1	150309
line filter Speisedruckfilter	1	154947
return flow filter Rücklauffilter	1	151945
leakage oil filter Leckölfiter	1	027376
249532 service package (250 h) / Service-Paket (250 h) 835E, 840E (L9 EU Stage V, VF)		
return flow filter Rücklauffilter	1	151945
leakage oil filter Leckölfiter	1	027376
ventilation filter Belüftungsfilter	1	153955
auxiliary control filter Vorsteuerfilter	1	150308
line filter Speisedruckfilter	1	154947
breather filter Entlüftungsfilter	1	168306
249531 service package (250 h) / Service-Paket (250 h) 835E, 840E (L9 EU Stage V, HC)		
return flow filter Rücklauffilter	1	151945
leakage oil filter Leckölfiter	1	027376
ventilation filter Belüftungsfilter	1	153955
HydroClean HydroClean	1	150309
line filter Speisedruckfilter	1	154947
breather filter Entlüftungsfilter	1	168306

Description / Bezeichnung	Qty. / St.	No. / Nr.
187024 service package (250 h) / Service-Paket (250 h) 850D, 860D (QSM 11 Tier 3 / IIIA, VF, WA)		
return flow filter Rücklauffilter	3	150307
engine oil filter Motorölfiter	1	189624
filter water separator Filter Wasserabscheider	1	103139
pressure filter Druckfilter	1	154933
fuel filter Kraftstofffilter	1	136897
leakage oil filter Leckölfiter	1	027376
auxiliary control filter Vorsteuerfilter	1	150308
164552 service package (250 h) / Service-Paket (250 h) 850D, 860D (QSM 11 Tier 3 / IIIA, VF, WAH)		
return flow filter Rücklauffilter	3	150307
engine oil filter Motorölfiter	1	189624
filter water separator Filter Wasserabscheider	1	165338
pressure filter Druckfilter	1	154933
fuel filter Kraftstofffilter	1	136897
leakage oil filter Leckölfiter	1	027376
auxiliary control filter Vorsteuerfilter	1	150308
187025 service package (250 h) / Service-Paket (250 h) 850D, 860D (QSM 11 Tier 3 / IIIA, HC, WA)		
return flow filter Rücklauffilter	3	150307
engine oil filter Motorölfiter	1	189624
filter water separator Filter Wasserabscheider	1	103139
pressure filter Druckfilter	1	154933
fuel filter Kraftstofffilter	1	136897
leakage oil filter Leckölfiter	1	027376
HydroClean HydroClean	1	150309
164553 service package (250 h) / Service-Paket (250 h) 850D, 860D (QSM 11 Tier 3 / IIIA, HC, WAH)		
return flow filter Rücklauffilter	3	150307
engine oil filter Motorölfiter	1	189624
filter water separator Filter Wasserabscheider	1	165338
pressure filter Druckfilter	1	154933
fuel filter Kraftstofffilter	1	136897
leakage oil filter Leckölfiter	1	027376
HydroClean HydroClean	1	150309
164556 service package (250 h) / Service-Paket (250 h) 870C (TCD 15 Tier 3 / IIIA, VF)		
return flow filter Rücklauffilter	3	150307
leakage oil filter Leckölfiter	1	027376
auxiliary control filter Vorsteuerfilter	1	150308

14.1 SERVICE PACKAGES (250 H) / SERVICE-PAKETE (250 H)

Description / Bezeichnung	Qty. / St.	No. / Nr.
164557 service package (250 h) / Service-Paket (250 h) 870C (TCD 15 Tier 3 / IIIA, HC)		
return flow filter Rücklauffilter	3	150307
leakage oil filter Leckölfilter	1	027376
HydroClean HydroClean	1	150309
187026 service package (250 h) / Service-Paket (250 h) 875E (Q5X 15 Tier 4i / IIIB)		
leakage oil filter Leckölfilter	2	027376
auxiliary control filter Vorsteuerfilter	2	150308
HydroClean HydroClean	1	150309
return flow filter Rücklauffilter	2	151945
pressure filter Druckfilter	2	154936
pressure filter Druckfilter	1	154938
filter water separator Filter Wasserabscheider	1	176434
182374 service package (250 h) / Service-Paket (250 h) 608, 613D (TCD 12 Tier 3 / IIIA, VF)		
return flow filter Rücklauffilter	1	150307
leakage oil filter Leckölfilter	1	027376
ventilation filter Belüftungsfilter	1	057228
auxiliary control filter Vorsteuerfilter	1	150308
pressure filter Druckfilter	1	205125
182375 service package (250 h) / Service-Paket (250 h) 608, 613D (TCD 12 Tier 3 / IIIA, HC)		
return flow filter Rücklauffilter	1	150307
leakage oil filter Leckölfilter	1	027376
ventilation filter Belüftungsfilter	1	057228
HydroClean HydroClean	1	150309
pressure filter Druckfilter	1	205125
238429 service package (250 h) / Service-Paket (250 h) 613E (FPT NEF 45 Tier 3 / IIIA, VF)		
auxiliary control filter Vorsteuerfilter	1	150308
return flow filter Rücklauffilter	1	150307
leakage oil filter Leckölfilter	1	063580
breather filter Entlüftungsfilter	1	168306
ventilation filter Belüftungsfilter	1	153955
238430 service package (250 h) / Service-Paket (250 h) 613E (FPT NEF 45 Tier 3 / IIIA, HC)		
HydroClean HydroClean	1	150309
return flow filter Rücklauffilter	1	150307
leakage oil filter Leckölfilter	1	063580
breather filter Entlüftungsfilter	1	168306
ventilation filter Belüftungsfilter	1	153955
225359 service package (250 h) / Service-Paket (250 h) 613E (FPT NEF 45 Tier 4f / IV, VF)		
auxiliary control filter Vorsteuerfilter	1	150308

Description / Bezeichnung	Qty. / St.	No. / Nr.
return flow filter Rücklauffilter	2	150307
leakage oil filter Leckölfilter	1	027376
breather filter Entlüftungsfilter	1	168306
ventilation filter Belüftungsfilter	1	153955
225363 service package (250 h) / Service-Paket (250 h) 613E (FPT NEF 45 Tier 4f / IV, HC)		
HydroClean HydroClean	1	150309
return flow filter Rücklauffilter	2	150307
leakage oil filter Leckölfilter	1	027376
breather filter Entlüftungsfilter	1	168306
ventilation filter Belüftungsfilter	1	153955
236477 service package (250 h) / Service-Paket (250 h) 633E, 643E (Q5B 4.5 Tier 3 / IIIA, VF)		
auxiliary control filter Vorsteuerfilter	1	150308
return flow filter Rücklauffilter	1	150307
leakage oil filter Leckölfilter	1	063580
breather filter Entlüftungsfilter	1	168306
ventilation filter Belüftungsfilter	1	153955
236478 service package (250 h) / Service-Paket (250 h) 633E, 643E (Q5B 4.5 Tier 3 / IIIA, HC)		
HydroClean HydroClean	1	150309
return flow filter Rücklauffilter	1	150307
leakage oil filter Leckölfilter	1	063580
breather filter Entlüftungsfilter	1	168306
ventilation filter Belüftungsfilter	1	153955
182378 service package (250 h) / Service-Paket (250 h) 643 (TCD 12 Tier 3 / IIIA, VF)		
return flow filter Rücklauffilter	1	150307
leakage oil filter Leckölfilter	1	027376
ventilation filter Belüftungsfilter	1	057228
auxiliary control filter Vorsteuerfilter	1	150308
182379 service package (250 h) / Service-Paket (250 h) 643 (TCD 12 Tier 3 / IIIA, HC)		
return flow filter Rücklauffilter	1	150307
leakage oil filter Leckölfilter	1	027376
ventilation filter Belüftungsfilter	1	057228
HydroClean HydroClean	1	150309
238555 service package (250 h) / Service-Paket (250 h) 643E (Q5B 4.5 Tier 4f / IV, VF)		
return flow filter Rücklauffilter	1	150307
leakage oil filter Leckölfilter	1	063580
ventilation filter Belüftungsfilter	1	153955
breather filter Entlüftungsfilter	1	168306
auxiliary control filter Vorsteuerfilter	1	150308

Description / Bezeichnung	Qty. / St.	No. / Nr.
238556 service package (250 h) / Service-Paket (250 h) 643E (Q5B 4.5 Tier 4f / IV, HC)		
return flow filter Rücklauffilter	1	150307
leakage oil filter Leckölfilter	1	063580
ventilation filter Belüftungsfilter	1	153955
breather filter Entlüftungsfilter	1	168306
HydroClean HydroClean	1	150309
236495 service package (250 h) / Service-Paket (250 h) 653E (Q5B 4.5 Tier 3 / IIIA, VF)		
return flow filter Rücklauffilter	2	150307
leakage oil filter Leckölfilter	1	027376
ventilation filter Belüftungsfilter	1	153955
breather filter Entlüftungsfilter	1	168306
auxiliary control filter Vorsteuerfilter	1	150308
236496 service package (250 h) / Service-Paket (250 h) 653E (Q5B 4.5 Tier 3 / IIIA, HC)		
return flow filter Rücklauffilter	2	150307
leakage oil filter Leckölfilter	1	027376
ventilation filter Belüftungsfilter	1	153955
breather filter Entlüftungsfilter	1	168306
HydroClean HydroClean	1	150309
232249 service package (250 h) / Service-Paket (250 h) 653E (Q5B 4.5 Tier 4f / IV, VF)		
auxiliary control filter Vorsteuerfilter	1	150308
return flow filter Rücklauffilter	1	150307
leakage oil filter Leckölfilter	1	027376
ventilation filter Belüftungsfilter	1	153955
222344 service package (250 h) / Service-Paket (250 h) 653E (Q5B 4.5 Tier 4f / IV, HC)		
HydroClean HydroClean	1	150309
return flow filter Rücklauffilter	1	150307
leakage oil filter Leckölfilter	1	027376
ventilation filter Belüftungsfilter	1	153955
236487 service package (250 h) / Service-Paket (250 h) 673E (Q5B 6.7 Tier 3 / IIIA, VF)		
return flow filter Rücklauffilter	2	150307
leakage oil filter Leckölfilter	1	027376
ventilation filter Belüftungsfilter	1	153955
auxiliary control filter Vorsteuerfilter	1	150308
236488 service package (250 h) / Service-Paket (250 h) 673E (Q5B 6.7 Tier 3 / IIIA, HC)		
return flow filter Rücklauffilter	2	150307
leakage oil filter Leckölfilter	1	027376
ventilation filter Belüftungsfilter	1	153955
HydroClean HydroClean	1	150309

14.1 SERVICE PACKAGES (250 H) / SERVICE-PAKETE (250 H)

Description / Bezeichnung	Qty. / St.	No. / Nr.
232252 service package (250 h) / Service-Paket (250 h) 673E (QSB 6.7 Tier 4f / IV, VF)		
auxiliary control filter <i>Vorsteuerfilter</i>	1	150308
return flow filter <i>Rücklauffilter</i>	2	150307
leakage oil filter <i>Leckölfilter</i>	1	027376
ventilation filter <i>Belüftungsfilter</i>	1	174541
186441 service package (250 h) / Service-Paket (250 h) 673E (QSB 6.7 Tier 4f / IV, HC)		
HydroClean <i>HydroClean</i>	1	150309
return flow filter <i>Rücklauffilter</i>	2	150307
leakage oil filter <i>Leckölfilter</i>	1	027376
ventilation filter <i>Belüftungsfilter</i>	1	174541
182380 service package (250 h) / Service-Paket (250 h) 683 (TCD 13 Tier 3 / IIIA, VF)		
auxiliary control filter <i>Vorsteuerfilter</i>	1	150308
return flow filter <i>Rücklauffilter</i>	2	150307
leakage oil filter <i>Leckölfilter</i>	1	027376
ventilation filter <i>Belüftungsfilter</i>	1	057228
182381 service package (250 h) / Service-Paket (250 h) 683 (TCD 13 Tier 3 / IIIA, HC)		
HydroClean <i>HydroClean</i>	1	150309
return flow filter <i>Rücklauffilter</i>	2	150307
leakage oil filter <i>Leckölfilter</i>	1	027376
ventilation filter <i>Belüftungsfilter</i>	1	057228
242395 service package (250 h) / Service-Paket (250 h) 6113E (QSB 6.7 Tier 3 / IIIA, VF)		
return flow filter <i>Rücklauffilter</i>	2	150307
leakage oil filter <i>Leckölfilter</i>	1	027376
ventilation filter <i>Belüftungsfilter</i>	1	153955
auxiliary control filter <i>Vorsteuerfilter</i>	1	150308
242396 service package (250 h) / Service-Paket (250 h) 6113E (QSB 6.7 Tier 3 / IIIA, HC)		
return flow filter <i>Rücklauffilter</i>	2	150307
leakage oil filter <i>Leckölfilter</i>	1	027376
ventilation filter <i>Belüftungsfilter</i>	1	153955
HydroClean <i>HydroClean</i>	1	150309
242486 service package (250 h) / Service-Paket (250 h) 6113E (QSB 6.7 Tier 4f / IV, VF)		
return flow filter <i>Rücklauffilter</i>	2	150307
leakage oil filter <i>Leckölfilter</i>	1	027376
ventilation filter <i>Belüftungsfilter</i>	1	153955
auxiliary control filter <i>Vorsteuerfilter</i>	1	150308
breather filter <i>Entlüftungsfilter</i>	1	168306

Description / Bezeichnung	Qty. / St.	No. / Nr.
242505 service package (250 h) / Service-Paket (250 h) 6113E (QSB 6.7 Tier 4f / IV, HC)		
HydroClean <i>HydroClean</i>	1	150309
leakage oil filter <i>Leckölfilter</i>	1	027376
ventilation filter <i>Belüftungsfilter</i>	1	153955
auxiliary control filter <i>Vorsteuerfilter</i>	1	150308
breather filter <i>Entlüftungsfilter</i>	1	168306
182376 service package (250 h) / Service-Paket (250 h) 630D (TCD 13 Tier 3 / IIIA, VF)		
return flow filter <i>Rücklauffilter</i>	2	150307
leakage oil filter <i>Leckölfilter</i>	1	027376
ventilation filter <i>Belüftungsfilter</i>	1	057228
auxiliary control filter <i>Vorsteuerfilter</i>	2	150308
pressure filter <i>Druckfilter</i>	1	205125
182377 service package (250 h) / Service-Paket (250 h) 630D (TCD 13 Tier 3 / IIIA, HC)		
return flow filter <i>Rücklauffilter</i>	2	150307
leakage oil filter <i>Leckölfilter</i>	1	027376
ventilation filter <i>Belüftungsfilter</i>	1	057228
HydroClean <i>HydroClean</i>	1	150309
auxiliary control filter <i>Vorsteuerfilter</i>	1	150308
pressure filter <i>Druckfilter</i>	1	205125
217278 service package (250 h) / Service-Paket (250 h) 640E (CAT C7.1)		
return flow filter <i>Rücklauffilter</i>	1	151945
leakage oil filter <i>Leckölfilter</i>	2	027376
HydroClean <i>HydroClean</i>	1	150309
auxiliary control filter <i>Vorsteuerfilter</i>	2	150308
line filter <i>Speisedruckfilter</i>	2	154947
236456 service package (250 h) / Service-Paket (250 h) 1100E (QSB 6.7 Tier 4f / IV, VF)		
auxiliary control filter <i>Vorsteuerfilter</i>	1	150308
return flow filter <i>Rücklauffilter</i>	1	151945
leakage oil filter <i>Leckölfilter</i>	1	027376
ventilation filter <i>Belüftungsfilter</i>	1	153955
breather filter <i>Entlüftungsfilter</i>	1	168306
236457 service package (250 h) / Service-Paket (250 h) 1100E (QSB 6.7 Tier 4f / IV, HC)		
HydroClean <i>HydroClean</i>	1	150309
return flow filter <i>Rücklauffilter</i>	1	151945
leakage oil filter <i>Leckölfilter</i>	1	027376
ventilation filter <i>Belüftungsfilter</i>	1	153955
breather filter <i>Entlüftungsfilter</i>	1	168306

Description / Bezeichnung	Qty. / St.	No. / Nr.
182382 service package (250 h) / Service-Paket (250 h) 2200 (Cat C7 Tier 3 / IIIA, VF)		
return flow filter <i>Rücklauffilter</i>	4	150307
leakage oil filter <i>Leckölfilter</i>	2	027376
ventilation filter <i>Belüftungsfilter</i>	1	057228
auxiliary control filter <i>Vorsteuerfilter</i>	1	150308
engine oil filter <i>Motorölfilter</i>	1	080749
fuel filter <i>Kraftstofffilter</i>	1	043277
filter water separator <i>Filter Wasserabscheider</i>	1	083176
182383 service package (250 h) / Service-Paket (250 h) 2200 (Cat C7 Tier 3 / IIIA, HC)		
return flow filter <i>Rücklauffilter</i>	4	150307
leakage oil filter <i>Leckölfilter</i>	2	027376
ventilation filter <i>Belüftungsfilter</i>	1	057228
HydroClean <i>HydroClean</i>	1	150309
engine oil filter <i>Motorölfilter</i>	1	080749
fuel filter <i>Kraftstofffilter</i>	1	043277
filter water separator <i>Filter Wasserabscheider</i>	1	083176
182384 service package (250 h) / Service-Paket (250 h) 2200E (Cat C7 Tier 3 / IIIA, VF)		
engine oil filter <i>Motorölfilter</i>	1	080749
auxiliary control filter <i>Vorsteuerfilter</i>	1	150308
return flow filter <i>Rücklauffilter</i>	1	151945
leakage oil filter <i>Leckölfilter</i>	2	027376
ventilation filter <i>Belüftungsfilter</i>	1	174541
fuel filter <i>Kraftstofffilter</i>	1	043277
filter water separator <i>Filter Wasserabscheider</i>	1	083176
182385 service package (250 h) / Service-Paket (250 h) 2200E (Cat C7 Tier 3 / IIIA, HC)		
engine oil filter <i>Motorölfilter</i>	1	080749
HydroClean <i>HydroClean</i>	1	150309
return flow filter <i>Rücklauffilter</i>	1	151945
leakage oil filter <i>Leckölfilter</i>	2	027376
ventilation filter <i>Belüftungsfilter</i>	1	174541
fuel filter <i>Kraftstofffilter</i>	1	043277
filter water separator <i>Filter Wasserabscheider</i>	1	083176
244271 service package (250 h) / Service-Paket (250 h) 2200E (CAT C7.1 Tier 4f / IV, VF)		
return flow filter <i>Rücklauffilter</i>	1	151945
leakage oil filter <i>Leckölfilter</i>	2	027376
ventilation filter <i>Belüftungsfilter</i>	1	174541
breather filter <i>Entlüftungsfilter</i>	1	168306
auxiliary control filter <i>Vorsteuerfilter</i>	1	150308

14.1 SERVICE PACKAGES (250 H) / SERVICE-PAKETE (250 H)

Description / Bezeichnung	Qty. / St.	No. / Nr.
244272 service package (250 h) / Service-Paket (250 h) 2200E (CAT C7.1 Tier 4f / IV, HC)		
return flow filter Rücklauffilter	1	151945
leakage oil filter Leckölfilter	2	027376
ventilation filter Belüftungsfilter	1	174541
breather filter Entlüftungsfilter	1	168306
HydroClean HydroClean	1	150309
182386 service package (250 h) / Service-Paket (250 h) 3300 (Cat C7 Tier 3 / IIIA, VF)		
return flow filter Rücklauffilter	3	150307
leakage oil filter Leckölfilter	2	027376
ventilation filter Belüftungsfilter	1	057228
auxiliary control filter Vorsteuerfilter	1	150308
engine oil filter Motorölfilter	1	080749
fuel filter Kraftstofffilter	1	043277
filter water separator Filter Wasserabscheider	1	083176
182387 service package (250 h) / Service-Paket (250 h) 3300 (Cat C7 Tier 3 / IIIA, HC)		
return flow filter Rücklauffilter	3	150307
leakage oil filter Leckölfilter	2	027376
ventilation filter Belüftungsfilter	1	057228
HydroClean HydroClean	1	150309
engine oil filter Motorölfilter	1	080749
fuel filter Kraftstofffilter	1	043277
filter water separator Filter Wasserabscheider	1	083176
182388 service package (250 h) / Service-Paket (250 h) 5500 (Cat C9 Tier 3 / IIIA, VF)		
return flow filter Rücklauffilter	3	150307
leakage oil filter Leckölfilter	2	027376
ventilation filter Belüftungsfilter	1	057228
auxiliary control filter Vorsteuerfilter	1	150308
engine oil filter Motorölfilter	1	085693

Description / Bezeichnung	Qty. / St.	No. / Nr.
fuel filter Kraftstofffilter	1	043277
filter water separator Filter Wasserabscheider	1	083176
182389 service package (250 h) / Service-Paket (250 h) 5500 (Cat C9 Tier 3 / IIIA, HC)		
return flow filter Rücklauffilter	3	150307
leakage oil filter Leckölfilter	2	027376
ventilation filter Belüftungsfilter	1	057228
HydroClean HydroClean	1	150309
engine oil filter Motorölfilter	1	085693
fuel filter Kraftstofffilter	1	043277
filter water separator Filter Wasserabscheider	1	083176
232393 service package (250 h) / Service-Paket (250 h) 5500E (Cat C9 Tier 3 / IIIA, VF)		
auxiliary control filter Vorsteuerfilter	1	150308
return flow filter Rücklauffilter	1	151945
leakage oil filter Leckölfilter	2	027376
ventilation filter Belüftungsfilter	1	153955
breather filter Entlüftungsfilter	1	168306
engine oil filter Motorölfilter	1	085693
fuel filter Kraftstofffilter	1	043277
filter water separator Filter Wasserabscheider	1	083176
232394 service package (250 h) / Service-Paket (250 h) 5500E (Cat C9 Tier 3 / IIIA, HC)		
HydroClean HydroClean	1	150309
return flow filter Rücklauffilter	1	151945
leakage oil filter Leckölfilter	2	027376
ventilation filter Belüftungsfilter	1	153955
breather filter Entlüftungsfilter	1	168306
engine oil filter Motorölfilter	1	085693
fuel filter Kraftstofffilter	1	043277
filter water separator Filter Wasserabscheider	1	083176

Description / Bezeichnung	Qty. / St.	No. / Nr.
231664 service package (250 h) / Service-Paket (250 h) 5500E (Cat C9.3 Tier 4f / IV, VF)		
auxiliary control filter Vorsteuerfilter	1	150308
return flow filter Rücklauffilter	1	151945
leakage oil filter Leckölfilter	2	027376
breather filter Entlüftungsfilter	1	168306
ventilation filter Belüftungsfilter	1	153955
231667 service package (250 h) / Service-Paket (250 h) 5500E (Cat C9.3 Tier 4f / IV, HC)		
HydroClean HydroClean	1	150309
return flow filter Rücklauffilter	1	151945
leakage oil filter Leckölfilter	2	027376
breather filter Entlüftungsfilter	1	168306
ventilation filter Belüftungsfilter	1	153955
182390 service package (250 h) / Service-Paket (250 h) 7700 (Cat C11 Tier 3 / IIIA, VF)		
return flow filter Rücklauffilter	3	150307
leakage oil filter Leckölfilter	2	027376
ventilation filter Belüftungsfilter	1	057228
auxiliary control filter Vorsteuerfilter	1	150308
engine oil filter Motorölfilter	1	085693
fuel filter Kraftstofffilter	1	105680
filter water separator Filter Wasserabscheider	1	083176
182391 service package (250 h) / Service-Paket (250 h) 7700 (Cat C11 Tier 3 / IIIA, HC)		
return flow filter Rücklauffilter	3	150307
leakage oil filter Leckölfilter	2	027376
ventilation filter Belüftungsfilter	1	057228
HydroClean HydroClean	1	150309
engine oil filter Motorölfilter	1	085693
fuel filter Kraftstofffilter	1	105680
filter water separator Filter Wasserabscheider	1	083176

14.2 SERVICE PACKAGES (500 H) SERVICE-PAKETE (500 H)

Description / Bezeichnung	Qty. / St.	No. / Nr.
245655 service package (500 h) / Service-Paket (500 h) 355E (FPT N45 Tier 4f)		
engine oil filter <i>Motorölfilter</i>	1	206076
fuel filter <i>Kraftstofffilter</i>	1	103142
filter water separator <i>Filter Wasserabscheider</i>	1	176434
254318 service package (500 h) / Service-Paket (500 h) 735E (QSL 9 Tier 3a)		
engine oil filter <i>Motorölfilter</i>	1	157835
fuel filter <i>Kraftstofffilter</i>	1	189578
water filter <i>Kühlwasserfilter</i>	1	158319
filter water separator <i>Filter Wasserabscheider</i>	1	176434
227806 service package (500 h) / Service-Paket (500 h) 718E, 723E, 730E (QSB 4.5 / 6.7 Tier 4f / IV)		
engine oil filter <i>Motorölfilter</i>	1	106924
fuel filter <i>Kraftstofffilter</i>	1	169951
filter water separator <i>Filter Wasserabscheider</i>	1	176434
201235 service package (500 h) / Service-Paket (500 h) 735E (QSL 9 Tier 4f / IV)		
water filter <i>Kühlwasserfilter</i>	1	158319
engine oil filter <i>Motorölfilter</i>	1	157835
fuel filter <i>Kraftstofffilter</i>	1	169951
filter water separator <i>Filter Wasserabscheider</i>	1	176434
249530 service package (500 h) / Service-Paket (500 h) 735E, 835E, 840E (L9 EU Stage V)		
engine oil filter <i>Motorölfilter</i>	1	244361
fuel filter <i>Kraftstofffilter</i>	1	169951
filter water separator <i>Filter Wasserabscheider</i>	1	176434
water filter <i>Kühlwasserfilter</i>	1	158319
180857 service package (500 h) / Service-Paket (500 h) 821C, 818D - 840D (QSB 4.5 / 6.7 Tier 3 / IIIA, WA)		
engine oil filter <i>Motorölfilter</i>	1	106924
fuel filter <i>Kraftstofffilter</i>	1	103142
filter water separator <i>Filter Wasserabscheider</i>	1	103139
180858 service package (500 h) / Service-Paket (500 h) 821C, 818D - 840D (QSB 4.5 / 6.7 Tier 3 / IIIA, WAH)		
engine oil filter <i>Motorölfilter</i>	1	106924
fuel filter <i>Kraftstofffilter</i>	1	103142
filter water separator, heatable <i>Filter Wasserabscheider, beheizbar</i>	1	109674
238772 service package (500 h) / Service-Paket (500 h) 817E (FPT N45 Tier 4f)		
engine oil filter <i>Motorölfilter</i>	1	206076
fuel filter <i>Kraftstofffilter</i>	1	103142
filter water separator <i>Filter Wasserabscheider</i>	1	176434

Description / Bezeichnung	Qty. / St.	No. / Nr.
180864 service package (500 h) / Service-Paket (500 h) 818E, 821E (QSB 4.5 Tier 3 / IIIA)		
engine oil filter <i>Motorölfilter</i>	1	106924
fuel filter <i>Kraftstofffilter</i>	1	103142
filter water separator <i>Filter Wasserabscheider</i>	1	103139
180863 service package (500 h) / Service-Paket (500 h) 818E, 821E (QSB 4.5 Tier 4i / IIIB)		
engine oil filter <i>Motorölfilter</i>	1	106924
fuel filter <i>Kraftstofffilter</i>	1	169951
filter water separator <i>Filter Wasserabscheider</i>	1	158317
219475 service package (500 h) / Service-Paket (500 h) 818E, 821E (QSB 4.5 Tier 4f / IV)		
engine oil filter <i>Motorölfilter</i>	1	106924
fuel filter <i>Kraftstofffilter</i>	1	169951
filter water separator <i>Filter Wasserabscheider</i>	1	176434
201820 service package (500 h) / Service-Paket (500 h) 830E (bis 830.x.2148, Tier 4i / IIIB)		
engine oil filter <i>Motorölfilter</i>	1	106924
fuel filter <i>Kraftstofffilter</i>	1	167975
filter water separator <i>Filter Wasserabscheider</i>	1	158317
180865 service package (500 h) / Service-Paket (500 h) 830E (QSB 6.7 Tier 4i / IIIB)		
engine oil filter <i>Motorölfilter</i>	1	106924
fuel filter <i>Kraftstofffilter</i>	1	167975
filter water separator <i>Filter Wasserabscheider</i>	1	158317
234009 service package (500 h) / Service-Paket (500 h) 825E, 830E (QSB 6.7 Tier 3 / IIIA)		
engine oil filter <i>Motorölfilter</i>	1	106924
fuel filter <i>Kraftstofffilter</i>	1	103142
filter water separator <i>Filter Wasserabscheider</i>	1	176434
198390 service package (500 h) / Service-Paket (500 h) 825E, 830E (QSB 6.7 Tier 4f / IV)		
engine oil filter <i>Motorölfilter</i>	1	106924
fuel filter <i>Kraftstofffilter</i>	1	169951
filter water separator <i>Filter Wasserabscheider</i>	1	176434
247947 service package (500 h) / Service-Paket (500 h) 825E, 830E (B 6.7 EU Stage V)		
engine oil filter <i>Motorölfilter</i>	1	106924
fuel filter <i>Kraftstofffilter</i>	1	169951
filter water separator <i>Filter Wasserabscheider</i>	1	176434
252384 service package (500 h) / Service-Paket (500 h) 835E (QSL 9 Tier 3 / IIIA)		
engine oil filter <i>Motorölfilter</i>	1	157835
fuel filter <i>Kraftstofffilter</i>	1	189578
filter water separator <i>Filter Wasserabscheider</i>	1	176434
water filter <i>Kühlwasserfilter</i>	1	158319

Description / Bezeichnung	Qty. / St.	No. / Nr.
180866 service package (500 h) / Service-Paket (500 h) 835E, 840E (QSL 9 Tier 4i / IIIB)		
engine oil filter <i>Motorölfilter</i>	1	157835
fuel filter <i>Kraftstofffilter</i>	1	158318
filter water separator <i>Filter Wasserabscheider</i>	1	158317
water filter <i>Kühlwasserfilter</i>	1	158319
187497 service package (500 h) / Service-Paket (500 h) 835E, 840E (QSL 9 Tier 4f / IV)		
engine oil filter <i>Motorölfilter</i>	1	157835
fuel filter <i>Kraftstofffilter</i>	1	169951
filter water separator <i>Filter Wasserabscheider</i>	1	176434
water filter <i>Kühlwasserfilter</i>	1	158319
180859 service package (500 h) / Service-Paket (500 h) 850D, 860D (QSM 11 Tier 3 / IIIA, WA)		
engine oil filter <i>Motorölfilter</i>	1	189624
filter water separator <i>Filter Wasserabscheider</i>	1	103139
fuel filter <i>Kraftstofffilter</i>	1	136897
water filter <i>Kühlwasserfilter</i>	1	136896
180860 service package (500 h) / Service-Paket (500 h) 850D, 860D (QSM 11 Tier 3 / IIIA, WAH)		
engine oil filter <i>Motorölfilter</i>	1	189624
filter water separator <i>Filter Wasserabscheider</i>	1	165338
fuel filter <i>Kraftstofffilter</i>	1	136897
water filter <i>Kühlwasserfilter</i>	1	136896
180861 service package (500 h) / Service-Paket (500 h) 870C (TCD 15 Tier 3 / IIIA)		
engine oil filter <i>Motorölfilter</i>	1	179462
fuel filter <i>Kraftstofffilter</i>	2	089014
filter water separator <i>Filter Wasserabscheider</i>	1	148781
187027 service package (500 h) / Service-Paket (500 h) 875E (QSX 15 Tier 4i / IIIB)		
engine oil filter <i>Motorölfilter</i>	1	189624
filter water separator <i>Filter Wasserabscheider</i>	1	176434
fuel filter <i>Kraftstofffilter</i>	1	189623
182392 service package (500 h) / Service-Paket (500 h) 608, 613D (TCD 12 Tier 3 / IIIA, WA)		
engine oil filter <i>Motorölfilter</i>	1	080543
fuel filter <i>Kraftstofffilter</i>	1	106109
filter water separator <i>Filter Wasserabscheider</i>	1	147645
187031 service package (500 h) / Service-Paket (500 h) 608, 613D (TCD 12 Tier 3 / IIIA, WAH)		
engine oil filter <i>Motorölfilter</i>	1	080543
fuel filter <i>Kraftstofffilter</i>	1	106109
filter water separator, heatable <i>Filter Wasserabscheider, beheizbar</i>	1	096151

14.2 SERVICE PACKAGES (500 h) / SERVICE-PAKETE (500 h)

Description / Bezeichnung	Qty. / St.	No. / Nr.
238431 service package (500 h) / Service-Paket (500 h) 613E (FPT NEF 45 Tier 3 / IIIA)		
engine oil filter <i>Motorölfilter</i>	1	206076
fuel filter <i>Kraftstofffilter</i>	1	103142
filter water separator <i>Filter Wasserabscheider</i>	1	176434
236479 service package (500 h) / Service-Paket (500 h) 633E, 653E, 673E (QSB 4.5 / 6.7 Tier 3 / IIIA)		
engine oil filter <i>Motorölfilter</i>	1	106924
fuel filter <i>Kraftstofffilter</i>	1	103142
filter water separator <i>Filter Wasserabscheider</i>	1	176434
225360 service package (500 h) / Service-Paket (500 h) 613E (FPT NEF 45 Tier 4f / IV)		
engine oil filter <i>Motorölfilter</i>	1	206076
fuel filter <i>Kraftstofffilter</i>	1	103142
fuel filter <i>Kraftstofffilter</i>	1	206184
filter safety cartridge <i>Filter Sicherheitspatrone</i>	1	149255
filter replacement cartridge <i>Filter Austauschpatrone</i>	1	149256
182394 service package (500 h) / Service-Paket (500 h) 643 (TCD 12 Tier 3 / IIIA, WA)		
engine oil filter <i>Motorölfilter</i>	1	027026
fuel filter <i>Kraftstofffilter</i>	2	084776
filter water separator <i>Filter Wasserabscheider</i>	1	147645
187035 service package (500 h) / Service-Paket (500 h) 643 (TCD 12 Tier 3 / IIIA, WAH)		
engine oil filter <i>Motorölfilter</i>	1	027026
fuel filter <i>Kraftstofffilter</i>	2	084776
filter water separator, heatable <i>Filter Wasserabscheider, beheizbar</i>	1	096151
238545 service package (500 h) / Service-Paket (500 h) 643E (QSB 4.5 Tier 3 / IIIA)		
engine oil filter <i>Motorölfilter</i>	1	106924
fuel filter <i>Kraftstofffilter</i>	1	103142
filter water separator <i>Filter Wasserabscheider</i>	1	176434

Description / Bezeichnung	Qty. / St.	No. / Nr.
236458 service package (500 h) / Service-Paket (500 h) 643E, 1100E (QSB 4.5 / 6.7 Tier 4f / IV)		
engine oil filter <i>Motorölfilter</i>	1	106924
fuel filter <i>Kraftstofffilter</i>	1	169951
filter water separator <i>Filter Wasserabscheider</i>	1	176434
186442 service package (500 h) / Service-Paket (500 h) 653E, 673E (QSB 6.7 Tier 4f / IV)		
engine oil filter <i>Motorölfilter</i>	1	106924
filter water separator <i>Filter Wasserabscheider</i>	1	176434
fuel filter <i>Kraftstofffilter</i>	1	169951
182395 service package (500 h) / Service-Paket (500 h) 683 (TCD 13 Tier 3 / IIIA, WA)		
engine oil filter <i>Motorölfilter</i>	1	027026
fuel filter <i>Kraftstofffilter</i>	2	084776
filter water separator <i>Filter Wasserabscheider</i>	1	147645
187039 service package (500 h) / Service-Paket (500 h) 683 (TCD 13 Tier 3 / IIIA, WAH)		
engine oil filter <i>Motorölfilter</i>	1	027026
fuel filter <i>Kraftstofffilter</i>	2	084776
filter water separator, heatable <i>Filter Wasserabscheider, beheizbar</i>	1	096151
242397 service package (500 h) / Service-Paket (500 h) 6113E (QSB 6.7 Tier 3 / IIIA)		
engine oil filter <i>Motorölfilter</i>	1	106924
fuel filter <i>Kraftstofffilter</i>	1	103142
filter water separator <i>Filter Wasserabscheider</i>	1	176434
242507 service package (500 h) / Service-Paket (500 h) 6113E (QSB 6.7 Tier 4f / IV)		
engine oil filter <i>Motorölfilter</i>	1	106924
fuel filter <i>Kraftstofffilter</i>	1	169951
filter water separator <i>Filter Wasserabscheider</i>	1	176434
182393 service package (500 h) / Service-Paket (500 h) 630D (TCD 13 Tier 3 / IIIA)		
engine oil filter <i>Motorölfilter</i>	1	027026
fuel filter <i>Kraftstofffilter</i>	2	084776
filter water separator <i>Filter Wasserabscheider</i>	1	147645

Description / Bezeichnung	Qty. / St.	No. / Nr.
217283 service package (500 h) / Service-Paket (500 h) 640E (CAT C7.1 Tier 4f / IV)		
engine oil filter <i>Motorölfilter</i>	1	177580
fuel filter <i>Kraftstofffilter</i>	2	177606
filter water separator <i>Filter Wasserabscheider</i>	1	171162
182397 service package (500 h) / Service-Paket (500 h) 2200, 2200E, 3300 (Cat C7 Tier 3 / IIIA)		
engine oil filter <i>Motorölfilter</i>	1	080749
fuel filter <i>Kraftstofffilter</i>	1	043277
filter water separator <i>Filter Wasserabscheider</i>	1	083176
244270 service package (500 h) / Service-Paket (500 h) 2200E (CAT C7.1 Tier 4f / IV)		
engine oil filter <i>Motorölfilter</i>	1	177580
fuel filter <i>Kraftstofffilter</i>	2	219995
filter water separator <i>Filter Wasserabscheider</i>	1	171162
182399 service package (500 h) / Service-Paket (500 h) 5500 (Cat C9 Tier 3 / IIIA)		
engine oil filter <i>Motorölfilter</i>	1	085693
fuel filter <i>Kraftstofffilter</i>	1	043277
filter water separator <i>Filter Wasserabscheider</i>	1	083176
232395 service package (500 h) / Service-Paket (500 h) 5500E (CAT C9 Tier 3 / IIIA)		
engine oil filter <i>Motorölfilter</i>	1	085693
fuel filter <i>Kraftstofffilter</i>	1	043277
filter water separator <i>Filter Wasserabscheider</i>	1	083176
213668 service package (500 h) / Service-Paket (500 h) 5500E (CAT C9.3 Tier 4f / IV)		
engine oil filter <i>Motorölfilter</i>	1	085693
fuel filter <i>Kraftstofffilter</i>	2	040247
filter water separator <i>Filter Wasserabscheider</i>	1	083176
182400 service package (500 h) / Service-Paket (500 h) 7700 (Cat C11 Tier 3 / IIIA)		
engine oil filter <i>Motorölfilter</i>	1	085693
fuel filter <i>Kraftstofffilter</i>	1	105680
filter water separator <i>Filter Wasserabscheider</i>	1	083176

14.3 SERVICE PACKAGES (1000 H) SERVICE-PAKETE (1000 H)

Description / Bezeichnung	Qty. / St.	No. / Nr.
245657 service package (1000 h) / Service-Paket (1000 h) 355E (FPT N45 Tier 4f)		
engine oil filter <i>Motorölfilter</i>	1	206076
fuel filter <i>Kraftstofffilter</i>	1	103142
filter water separator <i>Filter Wasserabscheider</i>	1	176434
filter air conditioner <i>Filter Klimaanlage</i>	1	138361
air filter safety cartridge <i>Sicherheitspatrone Luftfilter</i>	1	149255
air filter replacement cartridge <i>Austauschpatrone Luftfilter</i>	1	149256
V-belt <i>Keilriemen</i>	1	206172
V-belt air conditioner <i>Keilriemen Klimaanlage</i>	1	239043
227808 service package (1000 h) / Service-Paket (1000 h) 718, 723E (QSB 4.5 Tier 4f / IV)		
ventilation filter <i>Belüftungsfilter</i>	1	153955
engine oil filter <i>Motorölfilter</i>	1	106924
fuel filter <i>Kraftstofffilter</i>	1	169951
filter water separator <i>Filter Wasserabscheider</i>	1	176434
filter heater <i>Filter Heizung</i>	1	107202
filter heater, outside <i>Filter Heizung (außen)</i>	1	107060
filter safety cartridge <i>Filter Sicherheitspatrone</i>	1	167974
filter replacement cartridge <i>Filter Austauschpatrone</i>	1	187692
V-belt air condition <i>Keilriemen Klimaanlage</i>	1	172327
224544 service package (1000 h) / Service-Paket (1000 h) 730E (QSB 6.7 Tier 4f / IV)		
ventilation filter <i>Belüftungsfilter</i>	1	153955
engine oil filter <i>Motorölfilter</i>	1	106924
fuel filter <i>Kraftstofffilter</i>	1	169951
filter water separator <i>Filter Wasserabscheider</i>	1	176434
filter heater <i>Filter Heizung</i>	1	107202
filter heater, outside <i>Filter Heizung (außen)</i>	1	107060
filter safety cartridge <i>Filter Sicherheitspatrone</i>	1	167974
filter replacement cartridge <i>Filter Austauschpatrone</i>	1	167973
V-belt <i>Keilriemen</i>	1	167976
V-belt <i>Keilriemen</i>	1	161492
254319 service package (1000 h) / Service-Paket (1000 h) 735E (QSL 9 Tier 3a)		
engine oil filter <i>Motorölfilter</i>	1	157835
fuel filter <i>Kraftstofffilter</i>	1	189578
water filter <i>Kühlwasserfilter</i>	1	158319
filter water separator <i>Filter Wasserabscheider</i>	1	176434
filter heater, outside <i>Filter Heizung, außen</i>	1	107060
filter heater, inside <i>Filter Heizung, innen</i>	1	107202

Description / Bezeichnung	Qty. / St.	No. / Nr.
air filter replacement cartridge <i>Austauschpatrone Luftfilter</i>	2	205230
air filter safety cartridge <i>Sicherheitspatrone Luftfilter</i>	2	205231
201236 service package (1000 h) / Service-Paket (1000 h) 735E (QSL 9 Tier 4f / IV)		
ventilation filter <i>Belüftungsfilter</i>	1	153955
engine oil filter <i>Motorölfilter</i>	1	157835
fuel filter <i>Kraftstofffilter</i>	1	169951
filter water separator <i>Filter Wasserabscheider</i>	1	176434
filter heater <i>Filter Heizung</i>	1	107202
filter heater, outside <i>Filter Heizung (außen)</i>	1	107060
filter safety cartridge <i>Filter Sicherheitspatrone</i>	1	157839
filter replacement cartridge <i>Filter Austauschpatrone</i>	1	157840
V-belt <i>Keilriemen</i>	1	158322
V-belt <i>Keilriemen</i>	1	081733
water filter <i>Kühlwasserfilter</i>	1	158319
253214 service package (1000 h) / Service-Paket (1000 h) 735E (L9 EU Stage V)		
engine oil filter <i>Motorölfilter</i>	1	244361
fuel filter <i>Kraftstofffilter</i>	1	169951
filter water separator <i>Filter Wasserabscheider</i>	1	176434
filter heater, inside <i>Filter Heizung, innen</i>	1	107202
filter heater, outside <i>Filter Heizung, außen</i>	1	107060
air filter safety cartridge <i>Sicherheitspatrone Luftfilter</i>	2	205231
air filter replacement cartridge <i>Austauschpatrone Luftfilter</i>	2	205230
water filter <i>Kühlwasserfilter</i>	1	158319
238773 service package (1000 h) / Service-Paket (1000 h) 817E (FPT N45 Tier 4f)		
engine oil filter <i>Motorölfilter</i>	1	206076
fuel filter <i>Kraftstofffilter</i>	1	103142
filter water separator <i>Filter Wasserabscheider</i>	1	176434
filter air conditioner <i>Filter Klimaanlage</i>	1	138361
air filter safety cartridge <i>Sicherheitspatrone Luftfilter</i>	1	149255
air filter replacement cartridge <i>Austauschpatrone Luftfilter</i>	1	149256
ventilation filter <i>Belüftungsfilter</i>	1	153955
V-belt <i>Keilriemen</i>	1	206782
V-belt <i>Keilriemen</i>	1	206172
180928 service package (1000 h) / Service-Paket (1000 h) 818D (QSB 4.5 Tier 3 / IIIA, WA)		
engine oil filter <i>Motorölfilter</i>	1	106924
fuel filter <i>Kraftstofffilter</i>	1	103142
filter water separator <i>Filter Wasserabscheider</i>	1	103139

Description / Bezeichnung	Qty. / St.	No. / Nr.
air filter safety cartridge <i>Sicherheitspatrone Luftfilter</i>	1	072385
air filter replacement cartridge <i>Austauschpatrone Luftfilter</i>	1	072386
ventilation filter <i>Belüftungsfilter</i>	1	174541
filter air conditioner <i>Filter Klimaanlage</i>	1	138361
180929 service package (1000 h) / Service-Paket (1000 h) 818D (QSB 4.5 Tier 3 / IIIA, WAH)		
engine oil filter <i>Motorölfilter</i>	1	106924
fuel filter <i>Kraftstofffilter</i>	1	103142
filter water separator, heatable <i>Filter Wasserabscheider, beheizbar</i>	1	109674
air filter safety cartridge <i>Sicherheitspatrone Luftfilter</i>	1	072385
air filter replacement cartridge <i>Austauschpatrone Luftfilter</i>	1	072386
ventilation filter <i>Belüftungsfilter</i>	1	174541
filter air conditioner <i>Filter Klimaanlage</i>	1	138361
180930 service package (1000 h) / Service-Paket (1000 h) 821C (QSB 4.5 Tier 3 / IIIA, WA)		
engine oil filter <i>Motorölfilter</i>	1	106924
fuel filter <i>Kraftstofffilter</i>	1	103142
filter water separator <i>Filter Wasserabscheider</i>	1	103139
air filter safety cartridge <i>Sicherheitspatrone Luftfilter</i>	1	072385
air filter replacement cartridge <i>Austauschpatrone Luftfilter</i>	1	072386
ventilation filter <i>Belüftungsfilter</i>	1	057228
filter heater <i>Filter Heizung</i>	1	037257
180931 service package (1000 h) / Service-Paket (1000 h) 821C (QSB 4.5 Tier 3 / IIIA, WAH)		
engine oil filter <i>Motorölfilter</i>	1	106924
fuel filter <i>Kraftstofffilter</i>	1	103142
filter water separator, heatable <i>Filter Wasserabscheider, beheizbar</i>	1	109674
air filter safety cartridge <i>Sicherheitspatrone Luftfilter</i>	1	072385
air filter replacement cartridge <i>Austauschpatrone Luftfilter</i>	1	072386
ventilation filter <i>Belüftungsfilter</i>	1	057228
filter heater <i>Filter Heizung</i>	1	037257
180947 service package (1000 h) / Service-Paket (1000 h) 818E, 821E (QSB 4.5 Tier 3 / IIIA)		
ventilation filter <i>Belüftungsfilter</i>	1	153955
engine oil filter <i>Motorölfilter</i>	1	106924
fuel filter <i>Kraftstofffilter</i>	1	103142
filter water separator <i>Filter Wasserabscheider</i>	1	103139
filter heater <i>Filter Heizung</i>	1	107202
filter heater, outside <i>Filter Heizung (außen)</i>	1	107060
air filter safety cartridge <i>Sicherheitspatrone Luftfilter</i>	1	064200
air filter replacement cartridge <i>Austauschpatrone Luftfilter</i>	1	118606
V-belt air conditioner <i>Keilriemen Klimaanlage</i>	1	116125

14.3 SERVICE PACKAGES (1000 H) / SERVICE-PAKETE (1000 H)

Description / Bezeichnung	Qty. / St.	No. / Nr.
180946 service package (1000 h) / Service-Paket (1000 h) 818E, 821E (QSB 4.5 Tier 4i / IIIB)		
ventilation filter Belüftungsfilter	1	159955
engine oil filter Motorölfilter	1	106924
fuel filter Kraftstofffilter	1	169951
filter water separator Filter Wasserabscheider	1	158317
filter heater Filter Heizung	1	107202
filter heater, outside Filter Heizung (außen)	1	107060
filter safety cartridge Filter Sicherheitspatrone	1	169953
filter replacement cartridge Filter Austauschpatrone	1	169952
V-belt air conditioner Keilriemen Klimaanlage	1	172327
219476 service package (1000 h) / Service-Paket (1000 h) 818E, 821E (QSB 4.5 Tier 4f / IV)		
ventilation filter Belüftungsfilter	1	153955
engine oil filter Motorölfilter	1	106924
fuel filter Kraftstofffilter	1	169951
filter water separator Filter Wasserabscheider	1	176434
filter heater Filter Heizung	1	107202
filter heater, outside Filter Heizung (außen)	1	107060
filter safety cartridge Filter Sicherheitspatrone	1	167974
filter replacement cartridge Filter Austauschpatrone	1	187692
V-belt air conditioner Keilriemen Klimaanlage	1	172327
180932 service package (1000 h) / Service-Paket (1000 h) 825D, 830D (QSB 6.7 Tier 3 / IIIA, WA)		
engine oil filter Motorölfilter	1	106924
fuel filter Kraftstofffilter	1	103142
filter water separator Filter Wasserabscheider	1	103139
air filter safety cartridge Sicherheitspatrone Luftfilter	1	064200
air filter replacement cartridge Austauschpatrone Luftfilter	1	118606
ventilation filter Belüftungsfilter	1	174541
filter heater Filter Heizung	1	107202
filter heater, outside Filter Heizung (außen)	1	107060
180933 service package (1000 h) / Service-Paket (1000 h) 825D, 830D (QSB 6.7 Tier 3 / IIIA, WAH)		
engine oil filter Motorölfilter	1	106924
fuel filter Kraftstofffilter	1	103142
filter water separator, heatable Filter Wasserabscheider, beheizbar	1	109674
air filter safety cartridge Sicherheitspatrone Luftfilter	1	064200
air filter replacement cartridge Austauschpatrone Luftfilter	1	118606
ventilation filter Belüftungsfilter	1	174541
filter heater Filter Heizung	1	107202
filter heater, outside Filter Heizung (außen)	1	107060

Description / Bezeichnung	Qty. / St.	No. / Nr.
234010 service package (1000 h) / Service-Paket (1000 h) 825E, 830E (QSB 6.7 Tier 3 / IIIA)		
ventilation filter Belüftungsfilter	1	153955
engine oil filter Motorölfilter	1	106924
fuel filter Kraftstofffilter	1	103142
filter water separator Filter Wasserabscheider	1	176434
filter heater, inside Filter Heizung, innen	1	107202
filter heater, outside Filter Heizung, außen	1	107060
air filter safety cartridge Sicherheitspatrone Luftfilter	1	167974
air filter replacement cartridge Austauschpatrone Luftfilter	1	167973
V-belt Keilriemen	1	167976
V-belt Keilriemen	1	161492
247946 service package (1000 h) / Service-Paket (1000 h) 825E, 830E (B 6.7 EU Stage V)		
engine oil filter Motorölfilter	1	106924
fuel filter Kraftstofffilter	1	169951
filter water separator Filter Wasserabscheider	1	176434
filter heater, inside Filter Heizung, innen	1	107202
filter heater, outside Filter Heizung, außen	1	107060
air filter safety cartridge Sicherheitspatrone Luftfilter	1	167974
air filter replacement cartridge Austauschpatrone Luftfilter	1	167973
V-belt Keilriemen	1	167976
V-belt Keilriemen	1	161492
201821 service package (1000 h) / Service-Paket (1000 h) 830E (bis 830.x.2148, Tier 4i / IIIB)		
ventilation filter Belüftungsfilter	1	153955
engine oil filter Motorölfilter	1	106924
fuel filter Kraftstofffilter	1	167975
filter water separator Filter Wasserabscheider	1	158317
filter heater, inside Filter Heizung, innen	1	107202
filter heater, outside Filter Heizung, außen	1	107060
air filter safety cartridge Sicherheitspatrone Luftfilter	1	167974
air filter replacement cartridge Austauschpatrone Luftfilter	1	167973
V-belt Keilriemen	1	167976
V-belt Keilriemen	1	161492
180948 service package (1000 h) / Service-Paket (1000 h) 830E (QSB 6.7 Tier 4i / IIIB)		
ventilation filter Belüftungsfilter	1	153955
engine oil filter Motorölfilter	1	106924
fuel filter Kraftstofffilter	1	167975
filter water separator Filter Wasserabscheider	1	158317

Description / Bezeichnung	Qty. / St.	No. / Nr.
filter heater Filter Heizung	1	107202
filter heater, outside Filter Heizung (außen)	1	107060
filter safety cartridge Filter Sicherheitspatrone	1	167974
filter replacement cartridge Filter Austauschpatrone	1	167973
V-belt Keilriemen	1	167976
V-belt air conditioner Keilriemen Klimaanlage	1	161492
198391 sservice package (1000 h) / Service-Paket (1000 h) 825E, 830E (QSB 6.7 Tier 4f / IV)		
ventilation filter Belüftungsfilter	1	153955
engine oil filter Motorölfilter	1	106924
fuel filter Kraftstofffilter	1	169951
filter water separator Filter Wasserabscheider	1	176434
filter heater Filter Heizung	1	107202
filter heater, outside Filter Heizung (außen)	1	107060
filter safety cartridge Filter Sicherheitspatrone	1	167974
filter replacement cartridge Filter Austauschpatrone	1	167973
V-belt Keilriemen	1	167976
V-belt air conditioner Keilriemen Klimaanlage	1	161492
180934 service package (1000 h) / Service-Paket (1000 h) 835D, 840D (QSB 6.7 Tier 3 / IIIA, WA)		
engine oil filter Motorölfilter	1	106924
fuel filter Kraftstofffilter	1	103142
filter water separator Filter Wasserabscheider	1	103139
air filter safety cartridge Sicherheitspatrone Luftfilter	1	068827
air filter replacement cartridge Austauschpatrone Luftfilter	1	068826
ventilation filter Belüftungsfilter	1	174541
filter heater Filter Heizung	1	107202
filter heater, outside Filter Heizung (außen)	1	107060
180935 service package (1000 h) / Service-Paket (1000 h) 835D, 840D (QSB 6.7 Tier 3 / IIIA, WAH)		
engine oil filter Motorölfilter	1	106924
fuel filter Kraftstofffilter	1	103142
filter water separator, heatable Filter Wasserabscheider, beheizbar	1	109674
air filter safety cartridge Sicherheitspatrone Luftfilter	1	068827
air filter replacement cartridge Austauschpatrone Luftfilter	1	068826
ventilation filter Belüftungsfilter	1	174541
filter heater Filter Heizung	1	107202
filter heater, outside Filter Heizung (außen)	1	107060

14.3 SERVICE PACKAGES (1000 H) / SERVICE-PAKETE (1000 H)

Description / Bezeichnung	Qty. / St.	No. / Nr.
252385 service package (1000 h) / Service-Paket (1000 h) 835E (QSL9 Tier 3 / IIIA)		
engine oil filter <i>Motorölfilter</i>	1	157835
fuel filter <i>Kraftstofffilter</i>	1	189578
filter water separator <i>Filter Wasserabscheider</i>	1	176434
air filter safety cartridge <i>Sicherheitspatrone Luftfilter</i>	1	205231
air filter replacement cartridge <i>Austauschpatrone Luftfilter</i>	1	205230
V-belt <i>Keilriemen</i>	1	081733
V-belt <i>Keilriemen</i>	1	189579
filter heater, outside <i>Filter Heizung, außen</i>	1	107060
filter heater, inside <i>Filter Heizung, innen</i>	1	107202
water filter <i>Kühlwasserfilter</i>	1	158319
180950 service package (1000 h) / Service-Paket (1000 h) 835E, 840E (QSL 9 Tier 4i / IIIB)		
ventilation filter <i>BelüftungsfILTER</i>	1	153955
engine oil filter <i>Motorölfilter</i>	1	157835
fuel filter <i>Kraftstofffilter</i>	1	158318
filter water separator <i>Filter Wasserabscheider</i>	1	158317
water filter <i>Kühlwasserfilter</i>	1	158319
filter heater <i>Filter Heizung</i>	1	107202
filter heater, outside <i>Filter Heizung (außen)</i>	1	107060
filter safety cartridge <i>Filter Sicherheitspatrone</i>	1	157839
filter replacement cartridge <i>Filter Austauschpatrone</i>	1	157840
V-belt fan <i>Keilriemen Lüfter</i>	1	158322
V-belt air conditioner <i>Keilriemen Klimaanlage</i>	1	081733
187498 service package (1000 h) / Service-Paket (1000 h) 835E, 840E (QSL 9 Tier 4f / IV)		
ventilation filter <i>BelüftungsfILTER</i>	1	153955
engine oil filter <i>Motorölfilter</i>	1	157835
fuel filter <i>Kraftstofffilter</i>	1	169951
filter water separator <i>Filter Wasserabscheider</i>	1	176434
water filter <i>Kühlwasserfilter</i>	1	158319
filter heater <i>Filter Heizung</i>	1	107202
filter heater, outside <i>Filter Heizung (außen)</i>	1	107060
filter safety cartridge <i>Filter Sicherheitspatrone</i>	1	157839
filter replacement cartridge <i>Filter Austauschpatrone</i>	1	157840
V-belt fan <i>Keilriemen Lüfter</i>	1	158322
V-belt air conditioner <i>Keilriemen Klimaanlage</i>	1	081733
249529 service package (1000 h) / Service-Paket (1000 h) 835E, 840E (L9 EU Stage V)		
engine oil filter <i>Motorölfilter</i>	1	244361
fuel filter <i>Kraftstofffilter</i>	1	169951

Description / Bezeichnung	Qty. / St.	No. / Nr.
filter water separator <i>Filter Wasserabscheider</i>	1	176434
filter heater, outside <i>Filter Heizung, außen</i>	1	107060
filter heater, inside <i>Filter Heizung, innen</i>	1	107202
air filter safety cartridge <i>Sicherheitspatrone Luftfilter</i>	2	205231
air filter replacement cartridge <i>Austauschpatrone Luftfilter</i>	2	205230
water filter <i>Kühlwasserfilter</i>	1	158319
180936 service package (1000 h) / Service-Paket (1000 h) 850D, 860D (QSM 11 Tier 3 / IIIA, WA)		
engine oil filter <i>Motorölfilter</i>	1	189624
fuel filter <i>Kraftstofffilter</i>	1	136897
filter water separator <i>Filter Wasserabscheider</i>	1	103139
water filter <i>Kühlwasserfilter</i>	1	136896
air filter safety cartridge <i>Sicherheitspatrone Luftfilter</i>	1	068827
air filter replacement cartridge <i>Austauschpatrone Luftfilter</i>	1	068826
ventilation filter <i>BelüftungsfILTER</i>	1	174541
filter heater <i>Filter Heizung</i>	1	107202
filter heater, outside <i>Filter Heizung (außen)</i>	1	107060
180937 service package (1000 h) / Service-Paket (1000 h) 850D, 860D (QSM 11 Tier 3 / IIIA, WAH)		
engine oil filter <i>Motorölfilter</i>	1	189624
fuel filter <i>Kraftstofffilter</i>	1	136897
filter water separator <i>Filter Wasserabscheider</i>	1	165338
water filter <i>Kühlwasserfilter</i>	1	136896
air filter safety cartridge <i>Sicherheitspatrone Luftfilter</i>	1	068827
air filter replacement cartridge <i>Austauschpatrone Luftfilter</i>	1	068826
ventilation filter <i>BelüftungsfILTER</i>	1	174541
filter heater <i>Filter Heizung</i>	1	107202
filter heater, outside <i>Filter Heizung (außen)</i>	1	107060
180940 service package (1000 h) / Service-Paket (1000 h) 870C (TCD 15 Tier 3 / IIIA)		
engine oil filter <i>Motorölfilter</i>	1	179462
fuel filter <i>Kraftstofffilter</i>	2	089014
filter water separator <i>Filter Wasserabscheider</i>	1	148781
air filter safety cartridge <i>Sicherheitspatrone Luftfilter</i>	1	068827
air filter replacement cartridge <i>Austauschpatrone Luftfilter</i>	1	068826
ventilation filter <i>BelüftungsfILTER</i>	1	057228
filter heater <i>Filter Heizung</i>	1	107202
filter heater, outside <i>Filter Heizung (außen)</i>	1	107060
187028 service package (1000 h) / Service-Paket (1000 h) 875E (QXS 15 Tier 4i / IIIB)		
filter heater, outside <i>Filter Heizung (außen)</i>	1	107060
filter heater <i>Filter Heizung</i>	1	107202

Description / Bezeichnung	Qty. / St.	No. / Nr.
engine oil filter <i>Motorölfilter</i>	1	189624
ventilation filter <i>BelüftungsfILTER</i>	2	153955
filter replacement cartridge <i>Filter Austauschpatrone</i>	1	167973
filter safety cartridge <i>Filter Sicherheitspatrone</i>	1	167974
V-belt <i>Keilriemen</i>	1	170212
filter water separator <i>Filter Wasserabscheider</i>	1	176434
fuel filter <i>Kraftstofffilter</i>	1	189623
182402 service package (1000 h) / Service-Paket (1000 h) 608, 613D (TCD 12 Tier 3 / IIIA, WA)		
engine oil filter <i>Motorölfilter</i>	1	080543
fuel filter <i>Kraftstofffilter</i>	1	106109
filter water separator <i>Filter Wasserabscheider</i>	1	147645
filter air conditioner <i>Filter Klimaanlage</i>	1	138361
air filter safety cartridge <i>Sicherheitspatrone Luftfilter</i>	1	072385
air filter replacement cartridge <i>Austauschpatrone Luftfilter</i>	1	072386
187032 service package (1000 h) / Service-Paket (1000 h) 608, 613D (TCD 12 Tier 3 / IIIA, WAH)		
engine oil filter <i>Motorölfilter</i>	1	080543
fuel filter <i>Kraftstofffilter</i>	1	106109
filter water separator, heatable <i>Filter Wasserabscheider, beheizbar</i>	1	096151
filter air conditioner <i>Filter Klimaanlage</i>	1	138361
air filter safety cartridge <i>Sicherheitspatrone Luftfilter</i>	1	072385
air filter replacement cartridge <i>Austauschpatrone Luftfilter</i>	1	072386
238433 service package (1000 h) / Service-Paket (1000 h) 613E (FPT NEF 45 Tier 3 / IIIA)		
engine oil filter <i>Motorölfilter</i>	1	206076
fuel filter <i>Kraftstofffilter</i>	1	103142
filter water separator <i>Filter Wasserabscheider</i>	1	176434
air filter safety cartridge <i>Sicherheitspatrone Luftfilter</i>	1	149255
air filter replacement cartridge <i>Austauschpatrone Luftfilter</i>	1	149256
filter air conditioner <i>Filter Klimaanlage</i>	1	138361
225361 service package (1000 h) / Service-Paket (1000 h) 613E (FPT NEF 45 Tier 4f / IV)		
engine oil filter <i>Motorölfilter</i>	1	206076
fuel filter <i>Kraftstofffilter</i>	1	103142
fuel filter <i>Kraftstofffilter</i>	1	206184
filter safety cartridge <i>Filter Sicherheitspatrone</i>	1	149255
filter replacement cartridge <i>Filter Austauschpatrone</i>	1	149256
filter heater <i>Filter Heizung</i>	1	107202
filter heater, outside <i>Filter Heizung (außen)</i>	1	107060

14.3 SERVICE PACKAGES (1000 H) / SERVICE-PAKETE (1000 H)

Description / Bezeichnung	Qty. / St.	No. / Nr.
236481 service package (1000 h) / Service-Paket (1000 h) 633E (QSB 4.5 Tier 3 / IIIA)		
engine oil filter <i>Motorölfilter</i>	1	106924
fuel filter <i>Kraftstofffilter</i>	1	103142
filter water separator <i>Filter Wasserabscheider</i>	1	176434
air filter safety cartridge <i>Sicherheitspatrone Luftfilter</i>	1	064200
air filter replacement cartridge <i>Austauschpatrone Luftfilter</i>	1	118606
filter air conditioner <i>Filter Klimaanlage</i>	1	138361
182404 service package (1000 h) / Service-Paket (1000 h) 643 (TCD 12 Tier 3 / IIIA, WAH)		
engine oil filter <i>Motorölfilter</i>	1	027026
fuel filter <i>Kraftstofffilter</i>	2	084776
filter water separator <i>Filter Wasserabscheider</i>	1	147645
filter heater <i>Filter Heizung</i>	1	107202
filter heater, outside <i>Filter Heizung (außen)</i>	1	107060
air filter safety cartridge <i>Sicherheitspatrone Luftfilter</i>	1	100719
air filter replacement cartridge <i>Austauschpatrone Luftfilter</i>	1	100720
187036 service package (1000 h) / Service-Paket (1000 h) 643 (TCD 12 Tier 3 / IIIA, WAH)		
engine oil filter <i>Motorölfilter</i>	1	027026
fuel filter <i>Kraftstofffilter</i>	2	084776
filter water separator, heatable <i>Filter Wasserabscheider, beheizbar</i>	1	096151
filter heater <i>Filter Heizung</i>	1	107202
filter heater, outside <i>Filter Heizung (außen)</i>	1	107060
air filter safety cartridge <i>Sicherheitspatrone Luftfilter</i>	1	100719
air filter replacement cartridge <i>Austauschpatrone Luftfilter</i>	1	100720
238548 service package (1000 h) / Service-Paket (1000 h) 643E (QSB 4.5 Tier 3 / IIIA)		
engine oil filter <i>Motorölfilter</i>	1	106924
fuel filter <i>Kraftstofffilter</i>	1	103142
filter water separator <i>Filter Wasserabscheider</i>	1	176434
air filter safety cartridge <i>Sicherheitspatrone Luftfilter</i>	1	064200
air filter replacement cartridge <i>Austauschpatrone Luftfilter</i>	1	118606
filter air conditioner <i>Filter Klimaanlage</i>	1	138361
238558 service package (1000 h) / Service-Paket (1000 h) 643E (QSB 4.5 Tier 4f / IV)		
engine oil filter <i>Motorölfilter</i>	1	106924
fuel filter <i>Kraftstofffilter</i>	1	169951
filter water separator <i>Filter Wasserabscheider</i>	1	176434
filter air conditioner <i>Filter Klimaanlage</i>	1	138361
air filter safety cartridge <i>Sicherheitspatrone Luftfilter</i>	1	167974
air filter replacement cartridge <i>Austauschpatrone Luftfilter</i>	1	187692

Description / Bezeichnung	Qty. / St.	No. / Nr.
236498 service package (1000 h) / Service-Paket (1000 h) 653E (QSB 4.5 Tier 3 / IIIA)		
engine oil filter <i>Motorölfilter</i>	1	106924
fuel filter <i>Kraftstofffilter</i>	1	103142
filter water separator <i>Filter Wasserabscheider</i>	1	176434
filter heater, inside <i>Filter Heizung, innen</i>	1	107202
filter heater, outside <i>Filter Heizung, außen</i>	1	107060
air filter safety cartridge <i>Sicherheitspatrone Luftfilter</i>	1	064200
air filter replacement cartridge <i>Austauschpatrone Luftfilter</i>	1	118606
222345 service package (1000 h) / Service-Paket (1000 h) 653E (QSB 4.5 Tier 4f / IV)		
engine oil filter <i>Motorölfilter</i>	1	106924
fuel filter <i>Kraftstofffilter</i>	1	176434
fuel filter <i>Kraftstofffilter</i>	1	169951
filter safety cartridge <i>Filter Sicherheitspatrone</i>	1	167974
filter replacement cartridge <i>Filter Austauschpatrone</i>	1	187692
filter heater <i>Filter Heizung</i>	1	107202
filter heater, outside <i>Filter Heizung (außen)</i>	1	107060
236490 service package (1000 h) / Service-Paket (1000 h) 673E (QSB 6.7 Tier 3 / IIIA)		
engine oil filter <i>Motorölfilter</i>	1	106924
fuel filter <i>Kraftstofffilter</i>	1	103142
filter water separator <i>Filter Wasserabscheider</i>	1	176434
filter heater, inside <i>Filter Heizung, innen</i>	1	107202
filter heater, outside <i>Filter Heizung, außen</i>	1	107060
air filter safety cartridge <i>Sicherheitspatrone Luftfilter</i>	1	167974
air filter replacement cartridge <i>Austauschpatrone Luftfilter</i>	1	167973
186443 service package (1000 h) / Service-Paket (1000 h) 673E (QSB 6.7 Tier 4f / IV)		
engine oil filter <i>Motorölfilter</i>	1	106924
filter water separator <i>Filter Wasserabscheider</i>	1	176434
fuel filter <i>Kraftstofffilter</i>	1	169951
filter safety cartridge <i>Filter Sicherheitspatrone</i>	1	167974
filter replacement cartridge <i>Filter Austauschpatrone</i>	1	167973
filter heater <i>Filter Heizung</i>	1	107202
filter heater, outside <i>Filter Heizung (außen)</i>	1	107060
182405 service package (1000 h) / Service-Paket (1000 h) 683 (TCD 13 Tier 3 / IIIA, WAH)		
engine oil filter <i>Motorölfilter</i>	1	027026
fuel filter <i>Kraftstofffilter</i>	2	084776
filter water separator <i>Filter Wasserabscheider</i>	1	147645
air filter safety cartridge <i>Sicherheitspatrone Luftfilter</i>	1	064200

Description / Bezeichnung	Qty. / St.	No. / Nr.
air filter replacement cartridge <i>Austauschpatrone Luftfilter</i>	1	118606
filter heater <i>Filter Heizung</i>	1	107202
filter heater, outside <i>Filter Heizung (außen)</i>	1	107060
187040 service package (1000 h) / Service-Paket (1000 h) 683 (TCD 13 Tier 3 / IIIA, WAH)		
engine oil filter <i>Motorölfilter</i>	1	027026
fuel filter <i>Kraftstofffilter</i>	2	084776
filter water separator, heatable <i>Filter Wasserabscheider, beheizbar</i>	1	096151
air filter safety cartridge <i>Sicherheitspatrone Luftfilter</i>	1	064200
air filter replacement cartridge <i>Austauschpatrone Luftfilter</i>	1	118606
filter heater <i>Filter Heizung</i>	1	107202
filter heater, outside <i>Filter Heizung (außen)</i>	1	107060
242398 service package (1000 h) / Service-Paket (1000 h) 6113E (QSB 6.7 Tier 3 / IIIA)		
engine oil filter <i>Motorölfilter</i>	1	106924
fuel filter <i>Kraftstofffilter</i>	1	103142
filter water separator <i>Filter Wasserabscheider</i>	1	176434
filter heater, inside <i>Filter Heizung, innen</i>	1	107202
filter heater, outside <i>Filter Heizung, außen</i>	1	107060
air filter safety cartridge <i>Sicherheitspatrone Luftfilter</i>	1	167974
air filter replacement cartridge <i>Austauschpatrone Luftfilter</i>	1	167973
242508 service package (1000 h) / Service-Paket (1000 h) 6113E (QSB 6.7 Tier 4f / IV)		
engine oil filter <i>Motorölfilter</i>	1	106924
fuel filter <i>Kraftstofffilter</i>	1	169951
filter water separator <i>Filter Wasserabscheider</i>	1	176434
filter heater, inside <i>Filter Heizung, innen</i>	1	107202
filter heater, outside <i>Filter Heizung, außen</i>	1	107060
air filter safety cartridge <i>Sicherheitspatrone Luftfilter</i>	1	167974
air filter replacement cartridge <i>Austauschpatrone Luftfilter</i>	1	167973
182403 service package (1000 h) / Service-Paket (1000 h) 630D (TCD 13 Tier 3 / IIIA)		
engine oil filter <i>Motorölfilter</i>	1	027026
fuel filter <i>Kraftstofffilter</i>	2	084776
filter water separator <i>Filter Wasserabscheider</i>	1	147645
filter heater <i>Filter Heizung</i>	1	107202
filter heater, outside <i>Filter Heizung (außen)</i>	1	107060
air filter safety cartridge <i>Sicherheitspatrone Luftfilter</i>	1	064200
air filter replacement cartridge <i>Austauschpatrone Luftfilter</i>	1	118606

14.3 SERVICE PACKAGES (1000 H) / SERVICE-PAKETE (1000 H)

Description / Bezeichnung	Qty. / St.	No. / Nr.
217280 service package (1000 h) / Service-Paket (1000 h) 640E (CAT C7.1 Tier 3 / IIIA)		
engine oil filter <i>Motorölfilter</i>	1	177580
fuel filter <i>Kraftstofffilter</i>	2	177606
filter water separator <i>Filter Wasserabscheider</i>	1	064893
filter heater <i>Filter Heizung</i>	1	107202
filter heater, outside <i>Filter Heizung (außen)</i>	1	107060
air filter safety cartridge <i>Sicherheitspatrone Luftfilter</i>	1	149255
air filter replacement cartridge <i>Austauschpatrone Luftfilter</i>	1	149256
217284 service package (1000 h) / Service-Paket (1000 h) 640E (CAT C7.1 Tier 4f / IV)		
engine oil filter <i>Motorölfilter</i>	1	177580
fuel filter <i>Kraftstofffilter</i>	2	177606
filter water separator <i>Filter Wasserabscheider</i>	1	171162
filter heater <i>Filter Heizung</i>	1	107202
filter heater, outside <i>Filter Heizung (außen)</i>	1	107060
air filter safety cartridge <i>Sicherheitspatrone Luftfilter</i>	1	149255
air filter replacement cartridge <i>Austauschpatrone Luftfilter</i>	1	149256
236459 service package (1000 h) / Service-Paket (1000 h) 1100E (QSB 6.7 Tier 4f / IV)		
ventilation filter <i>BelüftungsfILTER</i>	1	153955
engine oil filter <i>Motorölfilter</i>	1	106924
fuel filter <i>Kraftstofffilter</i>	1	169951
filter water separator <i>Filter Wasserabscheider</i>	1	176434
air filter safety cartridge <i>Sicherheitspatrone Luftfilter</i>	1	167974
air filter replacement cartridge <i>Austauschpatrone Luftfilter</i>	1	167973
filter heater, inside <i>Filter Heizung, innen</i>	1	107202
filter heater, outside <i>Filter Heizung, außen</i>	1	107060
182407 service package (1000 h) / Service-Paket (1000 h) 2200 (Cat C7 Tier 3 / IIIA)		
engine oil filter <i>Motorölfilter</i>	1	080749
fuel filter <i>Kraftstofffilter</i>	1	043277
filter water separator <i>Filter Wasserabscheider</i>	1	083176
filter heater <i>Filter Heizung</i>	1	107202
filter heater, outside <i>Filter Heizung (außen)</i>	1	107060
air filter safety cartridge <i>Sicherheitspatrone Luftfilter</i>	1	064200
air filter replacement cartridge <i>Austauschpatrone Luftfilter</i>	1	118606

Description / Bezeichnung	Qty. / St.	No. / Nr.
182406 service package (1000 h) / Service-Paket (1000 h) 2200E (Cat C7 Tier 3 / IIIA)		
engine oil filter <i>Motorölfilter</i>	1	080749
fuel filter <i>Kraftstofffilter</i>	1	043277
filter water separator <i>Filter Wasserabscheider</i>	1	083176
air filter safety cartridge <i>Sicherheitspatrone Luftfilter</i>	1	149255
air filter replacement cartridge <i>Austauschpatrone Luftfilter</i>	1	149256
filter heater <i>Filter Heizung</i>	1	107202
filter heater, outside <i>Filter Heizung (außen)</i>	1	107060
244269 service package (1000 h) / Service-Paket (1000 h) 2200E (CAT C7.1 Tier 4f / IV)		
engine oil filter <i>Motorölfilter</i>	1	177580
fuel filter <i>Kraftstofffilter</i>	2	219995
filter water separator <i>Filter Wasserabscheider</i>	1	171162
filter heater, inside <i>Filter Heizung, innen</i>	1	107202
filter heater, outside <i>Filter Heizung, außen</i>	1	107060
air filter safety cartridge <i>Sicherheitspatrone Luftfilter</i>	1	149255
air filter replacement cartridge <i>Austauschpatrone Luftfilter</i>	1	149256
182408 service package (1000 h) / Service-Paket (1000 h) 3300 (Cat C7 Tier 3 / IIIA)		
engine oil filter <i>Motorölfilter</i>	1	080749
fuel filter <i>Kraftstofffilter</i>	1	043277
filter water separator <i>Filter Wasserabscheider</i>	1	083176
filter heater <i>Filter Heizung</i>	1	107202
filter heater, outside <i>Filter Heizung (außen)</i>	1	107060
air filter safety cartridge <i>Sicherheitspatrone Luftfilter</i>	1	064200
air filter replacement cartridge <i>Austauschpatrone Luftfilter</i>	1	118606
182409 service package (1000 h) / Service-Paket (1000 h) 5500 (Cat C9 Tier 3 / IIIA)		
engine oil filter <i>Motorölfilter</i>	1	085693
fuel filter <i>Kraftstofffilter</i>	1	043277
filter water separator <i>Filter Wasserabscheider</i>	1	083176
filter heater <i>Filter Heizung</i>	1	107202
filter heater, outside <i>Filter Heizung (außen)</i>	1	107060
air filter safety cartridge <i>Sicherheitspatrone Luftfilter</i>	1	068827
air filter replacement cartridge <i>Austauschpatrone Luftfilter</i>	1	068826

Description / Bezeichnung	Qty. / St.	No. / Nr.
232396 service package (1000 h) / Service-Paket (1000 h) 5500E (CAT C9 Tier 3 / IIIA)		
engine oil filter <i>Motorölfilter</i>	1	085693
fuel filter <i>Kraftstofffilter</i>	1	043277
filter water separator <i>Filter Wasserabscheider</i>	1	083176
air filter safety cartridge <i>Sicherheitspatrone Luftfilter</i>	1	146689
air filter replacement cartridge <i>Austauschpatrone Luftfilter</i>	1	146690
filter heater, inside <i>Filter Heizung, innen</i>	1	107202
filter heater, outside <i>Filter Heizung, außen</i>	1	107060
231674 service package (1000 h) / Service-Paket (1000 h) 5500E (CAT C9.3 Tier 4f / IV)		
engine oil filter <i>Motorölfilter</i>	1	085693
fuel filter <i>Kraftstofffilter</i>	2	040247
filter water separator <i>Filter Wasserabscheider</i>	1	083176
air filter safety cartridge <i>Sicherheitspatrone Luftfilter</i>	1	149255
air filter replacement cartridge <i>Austauschpatrone Luftfilter</i>	1	149256
filter heater <i>Filter Heizung</i>	1	107202
filter heater, outside <i>Filter Heizung (außen)</i>	1	107060
182410 service package (1000 h) / Service-Paket (1000 h) 7700 (Cat C11 Tier 3 / IIIA)		
engine oil filter <i>Motorölfilter</i>	1	085693
fuel filter <i>Kraftstofffilter</i>	1	105680
filter water separator <i>Filter Wasserabscheider</i>	1	083176
filter heater <i>Filter Heizung</i>	1	107202
filter heater, outside <i>Filter Heizung (außen)</i>	1	107060
air filter safety cartridge <i>Sicherheitspatrone Luftfilter</i>	1	068827
air filter replacement cartridge <i>Austauschpatrone Luftfilter</i>	1	068826

14.4 SERVICE PACKAGES (2000 H)

SERVICE-PAKETE (2000 H)

Description / Bezeichnung	Qty. / St.	No. / Nr.	Description / Bezeichnung	Qty. / St.	No. / Nr.	Description / Bezeichnung	Qty. / St.	No. / Nr.
245661 service package (2000 h) / Service-Paket (2000 h) 355E (FPT N45 Tier 4f, VF)			231015 service package (2000 h) / Service-Paket (2000 h) 723E (QSB 4.5 Tier 4f / IV, VF)			231018 service package (2000 h) / Service-Paket (2000 h) 730E (QSB 6.7 Tier 4f / IV, VF)		
return flow filter Rücklauffilter	1	228568	filter safety cartridge Filter Sicherheitspatrone	1	167974	engine oil filter Motorölfilter	1	106924
leakage oil filter Leckölfilter	1	063580	fuel filter Kraftstofffilter	1	169951	fuel filter Kraftstofffilter	1	169951
ventilation filter Belüftungsfilter	1	236336	filter crankcase ventilation Filter Kurbelgehäuseentlüftung	1	169954	filter water separator Filter Wasserabscheider	1	176434
auxiliary control filter Vorsteuerfilter	1	228567	V-belt Keilriemen	1	172327	V-belt Keilriemen	1	167976
breather filter Entlüftungsfilter	1	168306	filter water separator Filter Wasserabscheider	1	176434	V-belt Keilriemen	1	161492
engine oil filter Motorölfilter	1	206076	filter replacement cartridge Filter Austauschpatrone	1	187692	filter safety cartridge Filter Sicherheitspatrone	1	167974
fuel filter Kraftstofffilter	1	103142	231015 service package (2000 h) / Service-Paket (2000 h) 723E (QSB 4.5 Tier 4f / IV, VF)			filter replacement cartridge Filter Austauschpatrone	1	167973
filter water separator Filter Wasserabscheider	1	176434	engine oil filter Motorölfilter	1	106924	filter heater Filter Heizung	1	107202
filter air conditioner Filter Klimaanlage	1	138361	fuel filter Kraftstofffilter	1	169951	filter heater, outside Filter Heizung (außen)	1	107060
air filter safety cartridge Sicherheitspatrone Luftfilter	1	149255	filter water separator Filter Wasserabscheider	1	176434	ventilation filter Belüftungsfilter	1	153955
air filter replacement cartridge Austauschpatrone Luftfilter	1	149256	V-belt Keilriemen	1	172327	leakage oil filter Leckölfilter	1	027376
V-belt Keilriemen	1	206172	filter safety cartridge Filter Sicherheitspatrone	1	167974	auxiliary control filter Vorsteuerfilter	1	150308
V-belt air conditioner Keilriemen Klimaanlage	1	239043	filter replacement cartridge Filter Austauschpatrone	1	187692	line filter Speisedruckfilter	1	154947
227810 service package (2000 h) / Service-Paket (2000 h) 718E (QSB 4.5 Tier 4f / IV, VF)			filter heater Filter Heizung	1	107202	return flow filter Rücklauffilter	2	150307
leakage oil filter Leckölfilter	1	027376	filter heater, outside Filter Heizung (außen)	1	107060	filter crankcase ventilation Filter Kurbelgehäuseentlüftung	1	169482
engine oil filter Motorölfilter	1	106924	ventilation filter Belüftungsfilter	1	153955	224545 service package (2000 h) / Service-Paket (2000 h) 730E (QSB 6.7 Tier 4f / IV, HC)		
filter heater, outside Filter Heizung (außen)	1	107060	leakage oil filter Leckölfilter	1	027376	engine oil filter Motorölfilter	1	106924
filter heater Filter Heizung	1	107202	auxiliary control filter Vorsteuerfilter	1	150308	fuel filter Kraftstofffilter	1	169951
auxiliary control filter Vorsteuerfilter	1	150308	line filter Speisedruckfilter	1	154947	filter water separator Filter Wasserabscheider	1	176434
return flow filter Rücklauffilter	1	151945	return flow filter Rücklauffilter	1	150307	V-belt Keilriemen	1	167976
ventilation filter Belüftungsfilter	1	153955	filter crankcase ventilation Filter Kurbelgehäuseentlüftung	1	169954	V-belt Keilriemen	1	161492
line filter Speisedruckfilter	1	154947	224403 service package (2000 h) / Service-Paket (2000 h) 723E (QSB 4.5 Tier 4f / IV, HC)			filter safety cartridge Filter Sicherheitspatrone	1	167974
filter safety cartridge Filter Sicherheitspatrone	1	167974	engine oil filter Motorölfilter	1	106924	filter replacement cartridge Filter Austauschpatrone	1	167973
fuel filter Kraftstofffilter	1	169951	fuel filter Kraftstofffilter	1	169951	filter heater Filter Heizung	1	107202
filter crankcase ventilation Filter Kurbelgehäuseentlüftung	1	169954	filter water separator Filter Wasserabscheider	1	176434	filter heater, outside Filter Heizung (außen)	1	107060
V-belt Keilriemen	1	172327	V-belt Keilriemen	1	172327	ventilation filter Belüftungsfilter	1	153955
filter water separator Filter Wasserabscheider	1	176434	filter safety cartridge Filter Sicherheitspatrone	1	167974	leakage oil filter Leckölfilter	1	027376
filter replacement cartridge Filter Austauschpatrone	1	187692	filter replacement cartridge Filter Austauschpatrone	1	187692	HydroClean HydroClean	1	150309
227811 service package (2000 h) / Service-Paket (2000 h) 718E (QSB 4.5 Tier 4f / IV, HC)			filter heater Filter Heizung	1	107202	line filter Speisedruckfilter	1	154947
leakage oil filter Leckölfilter	1	027376	filter heater, outside Filter Heizung (außen)	1	107060	return flow filter Rücklauffilter	2	150307
engine oil filter Motorölfilter	1	106924	ventilation filter Belüftungsfilter	1	153955	filter crankcase ventilation Filter Kurbelgehäuseentlüftung	1	169482
filter heater, outside Filter Heizung (außen)	1	107060	leakage oil filter Leckölfilter	1	027376	254320 service package (2000 h) / Service-Paket (2000 h) 735E (QSL 9 Tier 3a, VF)		
filter heater Filter Heizung	1	107202	HydroClean HydroClean	1	150309	ventilation filter Belüftungsfilter	1	153955
HydroClean HydroClean	1	150309	line filter Speisedruckfilter	1	154947	auxiliary control filter Vorsteuerfilter	1	150308
return flow filter Rücklauffilter	1	151945	return flow filter Rücklauffilter	1	150307	leakage oil filter Leckölfilter	1	027376
ventilation filter Belüftungsfilter	1	153955	filter crankcase ventilation Filter Kurbelgehäuseentlüftung	1	169954	line filter Speisedruckfilter	1	154947
line filter Speisedruckfilter	1	154947						

14.4 SERVICE PACKAGES (2000 H) / SERVICE-PAKETE (2000 H)

Description / Bezeichnung	Qty. / St.	No. / Nr.
breather filter Entlüftungsfilter	1	168306
engine oil filter Motorölfilter	1	157835
fuel filter Kraftstofffilter	1	189578
water filter Kühlwasserfilter	1	158319
filter water separator Filter Wasserabscheider	1	176434
filter heater, outside Filter Heizung, außen	1	107060
filter heater, inside Filter Heizung, innen	1	107202
air filter replacement cartridge Austauschpatrone Luftfilter	2	205230
air filter safety cartridge Sicherheitspatrone Luftfilter	2	205231
V-belt Keilriemen	1	081733
V-belt Keilriemen	1	189579
254321 service package (2000 h) / Service-Paket (2000 h) 735E (QSL 9 Tier 3a, HC)		
ventilation filter Belüftungsfilter	1	153955
HydroClean HydroClean	1	150309
leakage oil filter Leckölfilter	1	027376
line filter Speisedruckfilter	1	154947
return flow filter Rücklaufilter	2	150307
breather filter Entlüftungsfilter	1	168306
engine oil filter Motorölfilter	1	157835
fuel filter Kraftstofffilter	1	189578
water filter Kühlwasserfilter	1	158319
filter water separator Filter Wasserabscheider	1	176434
filter heater, outside Filter Heizung, außen	1	107060
filter heater, inside Filter Heizung, innen	1	107202
air filter replacement cartridge Austauschpatrone Luftfilter	2	205230
air filter safety cartridge Sicherheitspatrone Luftfilter	2	205231
V-belt Keilriemen	1	081733
V-belt Keilriemen	1	189579
231020 service package (2000 h) / Service-Paket (2000 h) 735E (QSL 9 Tier 4f / IV, VF)		
engine oil filter Motorölfilter	1	157835
fuel filter Kraftstofffilter	1	169951
filter water separator Filter Wasserabscheider	1	176434
V-belt Keilriemen	1	158322
V-belt Keilriemen	1	081733
filter safety cartridge Filter Sicherheitspatrone	1	157839
filter replacement cartridge Filter Austauschpatrone	1	157840
filter heater Filter Heizung	1	107202
filter heater, outside Filter Heizung (außen)	1	107060

Description / Bezeichnung	Qty. / St.	No. / Nr.
ventilation filter Belüftungsfilter	1	153955
leakage oil filter Leckölfilter	1	027376
auxiliary control filter Vorsteuerfilter	1	150308
line filter Speisedruckfilter	1	154947
return flow filter Rücklaufilter	2	150307
filter crankcase ventilation Filter Kurbelgehäuseentlüftung	1	169483
water filter Kühlwasserfilter	1	158319
201237 service package (2000 h) / Service-Paket (2000 h) 735E (QSL 9 Tier 4f / IV, HC)		
engine oil filter Motorölfilter	1	157835
fuel filter Kraftstofffilter	1	169951
filter water separator Filter Wasserabscheider	1	176434
V-belt Keilriemen	1	158322
V-belt Keilriemen	1	081733
filter safety cartridge Filter Sicherheitspatrone	1	157839
filter replacement cartridge Filter Austauschpatrone	1	157840
filter heater Filter Heizung	1	107202
filter heater, outside Filter Heizung (außen)	1	107060
ventilation filter Belüftungsfilter	1	153955
leakage oil filter Leckölfilter	1	027376
HydroClean HydroClean	1	150309
line filter Speisedruckfilter	1	154947
return flow filter Rücklaufilter	2	150307
filter crankcase ventilation Filter Kurbelgehäuseentlüftung	1	169483
water filter Kühlwasserfilter	1	158319
253215 service package (2000 h) / Service-Paket (2000 h) 735E (L9 EU Stage V, VF)		
return flow filter Rücklaufilter	2	150307
leakage oil filter Leckölfilter	1	027376
ventilation filter Belüftungsfilter	1	153955
auxiliary control filter Vorsteuerfilter	1	150308
breather filter Entlüftungsfilter	1	168306
engine oil filter Motorölfilter	1	244361
fuel filter Kraftstofffilter	1	169951
filter water separator Filter Wasserabscheider	1	176434
air filter safety cartridge Sicherheitspatrone Luftfilter	2	205231
air filter replacement cartridge Austauschpatrone Luftfilter	2	205230
V-belt Keilriemen	1	158322
V-belt Keilriemen	1	081733
line filter Speisedruckfilter	1	154947

Description / Bezeichnung	Qty. / St.	No. / Nr.
filter heater, inside Filter Heizung, innen	1	107202
filter heater, outside Filter Heizung, außen	1	107060
water filter Kühlwasserfilter	1	158319
253216 service package (2000 h) / Service-Paket (2000 h) 735E (L9 EU Stage V, HC)		
return flow filter Rücklaufilter	2	150307
leakage oil filter Leckölfilter	1	027376
ventilation filter Belüftungsfilter	1	153955
HydroClean HydroClean	1	150309
breather filter Entlüftungsfilter	1	168306
engine oil filter Motorölfilter	1	244361
fuel filter Kraftstofffilter	1	169951
filter water separator Filter Wasserabscheider	1	176434
air filter safety cartridge Sicherheitspatrone Luftfilter	2	205231
air filter replacement cartridge Austauschpatrone Luftfilter	2	205230
filter heater, inside Filter Heizung, innen	1	107202
filter heater, outside Filter Heizung, außen	1	107060
V-belt Keilriemen	1	158322
V-belt Keilriemen	1	081733
line filter Speisedruckfilter	1	154947
water filter Kühlwasserfilter	1	158319
238774 service package (2000 h) / Service-Paket (2000 h) 817E (FPT N45 Tier 4f, VF)		
return flow filter Rücklaufilter	1	150307
leakage oil filter Leckölfilter	1	027376
ventilation filter Belüftungsfilter	1	153955
breather filter Entlüftungsfilter	1	168306
auxiliary control filter Vorsteuerfilter	1	150308
engine oil filter Motorölfilter	1	206076
fuel filter Kraftstofffilter	1	103142
filter water separator Filter Wasserabscheider	1	176434
filter air conditioner Filter Klimaanlage	1	138361
air filter safety cartridge Sicherheitspatrone Luftfilter	1	149255
air filter replacement cartridge Austauschpatrone Luftfilter	1	149256
line filter Speisedruckfilter	1	154947
V-belt Keilriemen	1	206782
V-belt Keilriemen	1	206172

14.4 SERVICE PACKAGES (2000 H) / SERVICE-PAKETE (2000 H)

Description / Bezeichnung	Qty. / St.	No. / Nr.
238775 service package (2000 h) / Service-Paket (2000 h) 817E (FPT N45 Tier 4f, HC)		
return flow filter Rücklaufilter	1	150307
leakage oil filter Leckölfilter	1	027376
ventilation filter Belüftungsfilter	1	153955
breather filter Entlüftungsfilter	1	168306
HydroClean HydroClean	1	150309
engine oil filter Motorölfilter	1	206076
fuel filter Kraftstofffilter	1	103142
filter water separator Filter Wasserabscheider	1	176434
filter air conditioner Filter Klimaanlage	1	138361
air filter safety cartridge Sicherheitspatrone Luftfilter	1	149255
air filter replacement cartridge Austauschpatrone Luftfilter	1	149256
line filter Speisedruckfilter	1	154947
V-belt Keilriemen	1	206782
V-belt Keilriemen	1	206172
181054 service package (2000 h) / Service-Paket (2000 h) 818D (QSB 4.5 Tier 3 / IIIA, VF, WA)		
return flow filter Rücklaufilter	1	150307
leakage oil filter Leckölfilter	1	027376
ventilation filter Belüftungsfilter	1	174541
auxiliary control filter Vorsteuerfilter	1	150308
engine oil filter Motorölfilter	1	106924
fuel filter Kraftstofffilter	1	103142
filter water separator Filter Wasserabscheider	1	103139
filter air conditioner Filter Klimaanlage	1	138361
air filter safety cartridge Sicherheitspatrone Luftfilter	1	072385
air filter replacement cartridge Austauschpatrone Luftfilter	1	072386
V-belt air conditioner Keilriemen Klimaanlage	1	116125
181055 service package (2000 h) / Service-Paket (2000 h) 818D (QSB 4.5 Tier 3 / IIIA, VF, WAH)		
return flow filter Rücklaufilter	1	150307
leakage oil filter Leckölfilter	1	027376
ventilation filter Belüftungsfilter	1	174541
auxiliary control filter Vorsteuerfilter	1	150308
engine oil filter Motorölfilter	1	106924
fuel filter Kraftstofffilter	1	103142
filter water separator, heatable Filter Wasserabscheider, beheizbar	1	109674
filter air conditioner Filter Klimaanlage	1	138361
air filter safety cartridge Sicherheitspatrone Luftfilter	1	072385
air filter replacement cartridge Austauschpatrone Luftfilter	1	072386
V-belt air conditioner Keilriemen Klimaanlage	1	116125

Description / Bezeichnung	Qty. / St.	No. / Nr.
181056 service package (2000 h) / Service-Paket (2000 h) 818D (QSB 4.5 Tier 3 / IIIA, HC, WA)		
return flow filter Rücklaufilter	1	150307
leakage oil filter Leckölfilter	1	027376
ventilation filter Belüftungsfilter	1	174541
HydroClean HydroClean	1	150309
engine oil filter Motorölfilter	1	106924
fuel filter Kraftstofffilter	1	103142
filter water separator Filter Wasserabscheider	1	103139
filter air conditioner Filter Klimaanlage	1	138361
air filter safety cartridge Sicherheitspatrone Luftfilter	1	072385
air filter replacement cartridge Austauschpatrone Luftfilter	1	072386
V-belt air conditioner Keilriemen Klimaanlage	1	116125
181057 service package (2000 h) / Service-Paket (2000 h) 818D (QSB 4.5 Tier 3 / IIIA, HC, WAH)		
return flow filter Rücklaufilter	1	150307
leakage oil filter Leckölfilter	1	027376
ventilation filter Belüftungsfilter	1	174541
HydroClean HydroClean	1	150309
engine oil filter Motorölfilter	1	106924
fuel filter Kraftstofffilter	1	103142
filter water separator, heatable Filter Wasserabscheider, beheizbar	1	109674
filter air conditioner Filter Klimaanlage	1	138361
air filter safety cartridge Sicherheitspatrone Luftfilter	1	072385
air filter replacement cartridge Austauschpatrone Luftfilter	1	072386
V-belt air conditioner Keilriemen Klimaanlage	1	116125
181058 service package (2000 h) / Service-Paket (2000 h) 821C (QSB 4.5 Tier 3 / IIIA, VF, WA)		
return flow filter Rücklaufilter	1	150307
leakage oil filter Leckölfilter	1	027376
auxiliary control filter Vorsteuerfilter	1	150308
ventilation filter Belüftungsfilter	1	057228
engine oil filter Motorölfilter	1	106924
fuel filter Kraftstofffilter	1	103142
filter water separator Filter Wasserabscheider	1	103139
filter heater Filter Heizung	1	037257
air filter safety cartridge Sicherheitspatrone Luftfilter	1	072385
air filter replacement cartridge Austauschpatrone Luftfilter	1	072386
V-belt air conditioner Keilriemen Klimaanlage	1	116125

Description / Bezeichnung	Qty. / St.	No. / Nr.
181059 service package (2000 h) / Service-Paket (2000 h) 821C (QSB 4.5 Tier 3 / IIIA, VF, WAH)		
return flow filter Rücklaufilter	1	150307
leakage oil filter Leckölfilter	1	027376
auxiliary control filter Vorsteuerfilter	1	150308
ventilation filter Belüftungsfilter	1	057228
engine oil filter Motorölfilter	1	106924
fuel filter Kraftstofffilter	1	103142
filter water separator, heatable Filter Wasserabscheider, beheizbar	1	109674
filter heater Filter Heizung	1	037257
air filter safety cartridge Sicherheitspatrone Luftfilter	1	072385
air filter replacement cartridge Austauschpatrone Luftfilter	1	072386
V-belt air conditioner Keilriemen Klimaanlage	1	116125
181060 service package (2000 h) / Service-Paket (2000 h) 821C (QSB 4.5 Tier 3 / IIIA, HC, WA)		
return flow filter Rücklaufilter	1	150307
leakage oil filter Leckölfilter	1	027376
HydroClean HydroClean	1	150309
ventilation filter Belüftungsfilter	1	057228
engine oil filter Motorölfilter	1	106924
fuel filter Kraftstofffilter	1	103142
filter water separator Filter Wasserabscheider	1	103139
filter heater Filter Heizung	1	037257
air filter safety cartridge Sicherheitspatrone Luftfilter	1	072385
air filter replacement cartridge Austauschpatrone Luftfilter	1	072386
V-belt air conditioner Keilriemen Klimaanlage	1	116125
181061 service package (2000 h) / Service-Paket (2000 h) 821C (QSB 4.5 Tier 3 / IIIA, HC, WAH)		
return flow filter Rücklaufilter	1	150307
leakage oil filter Leckölfilter	1	027376
HydroClean HydroClean	1	150309
ventilation filter Belüftungsfilter	1	057228
engine oil filter Motorölfilter	1	106924
fuel filter Kraftstofffilter	1	103142
filter water separator, heatable Filter Wasserabscheider, beheizbar	1	109674
filter heater Filter Heizung	1	037257
air filter safety cartridge Sicherheitspatrone Luftfilter	1	072385
air filter replacement cartridge Austauschpatrone Luftfilter	1	072386
V-belt air conditioner Keilriemen Klimaanlage	1	116125

14.4 SERVICE PACKAGES (2000 H) / SERVICE-PAKETE (2000 H)

Description / Bezeichnung	Qty. / St.	No. / Nr.
180990 service package (2000 h) / Service-Paket (2000 h) 818E, 821E (QSB 4.5 Tier 3 / IIIA, VF)		
return flow filter Rücklauffilter	1	150307
leakage oil filter Leckölfilter	1	027376
ventilation filter Belüftungsfilter	1	153955
auxiliary control filter Vorsteuerfilter	1	150308
engine oil filter Motorölfilter	1	106924
fuel filter Kraftstofffilter	1	103142
filter water separator Filter Wasserabscheider	1	103139
line filter Speisedruckfilter	1	154947
filter heater Filter Heizung	1	107202
filter heater, outside Filter Heizung (außen)	1	107060
air filter safety cartridge Sicherheitspatrone Luftfilter	1	064200
air filter replacement cartridge Austauschpatrone Luftfilter	1	118606
V-belt air conditioner Keilriemen Klimaanlage	1	116125
180991 service package (2000 h) / Service-Paket (2000 h) 818E, 821E (QSB 4.5 Tier 3 / IIIA, HC)		
return flow filter Rücklauffilter	1	150307
leakage oil filter Leckölfilter	1	027376
ventilation filter Belüftungsfilter	1	153955
HydroClean HydroClean	1	150309
engine oil filter Motorölfilter	1	106924
fuel filter Kraftstofffilter	1	103142
filter water separator Filter Wasserabscheider	1	103139
line filter Speisedruckfilter	1	154947
filter heater Filter Heizung	1	107202
filter heater, outside Filter Heizung (außen)	1	107060
air filter safety cartridge Sicherheitspatrone Luftfilter	1	064200
air filter replacement cartridge Austauschpatrone Luftfilter	1	118606
V-belt air conditioner Keilriemen Klimaanlage	1	116125
180988 service package (2000 h) / Service-Paket (2000 h) 818E, 821E (QSB 4.5 Tier 4i / IIIB, VF)		
return flow filter Rücklauffilter	1	150307
leakage oil filter Leckölfilter	1	027376
ventilation filter Belüftungsfilter	1	153955
auxiliary control filter Vorsteuerfilter	1	150308
engine oil filter Motorölfilter	1	106924
fuel filter Kraftstofffilter	1	169951
filter water separator Filter Wasserabscheider	1	158317
filter crankcase ventilation Filter Kurbelgehäuseentlüftung	1	169954
line filter Speisedruckfilter	1	154947

Description / Bezeichnung	Qty. / St.	No. / Nr.
filter heater Filter Heizung	1	107202
filter heater, outside Filter Heizung (außen)	1	107060
filter safety cartridge Filter Sicherheitspatrone	1	169953
filter replacement cartridge Filter Austauschpatrone	1	169952
V-belt air conditioner Keilriemen Klimaanlage	1	172327
180989 service package (2000 h) / Service-Paket (2000 h) 818E, 821E (QSB 4.5 Tier 4i / IIIB, HC)		
return flow filter Rücklauffilter	1	150307
leakage oil filter Leckölfilter	1	027376
ventilation filter Belüftungsfilter	1	153955
HydroClean HydroClean	1	150309
engine oil filter Motorölfilter	1	106924
fuel filter Kraftstofffilter	1	169951
filter water separator Filter Wasserabscheider	1	158317
filter crankcase ventilation Filter Kurbelgehäuseentlüftung	1	169954
line filter Speisedruckfilter	1	154947
filter heater Filter Heizung	1	107202
filter heater, outside Filter Heizung (außen)	1	107060
filter safety cartridge Filter Sicherheitspatrone	1	169953
filter replacement cartridge Filter Austauschpatrone	1	169952
V-belt air conditioner Keilriemen Klimaanlage	1	172327
219477 service package (2000 h) / Service-Paket (2000 h) 818E, 821E (QSB 4.5 Tier 4f / IV, VF)		
engine oil filter Motorölfilter	1	106924
fuel filter Kraftstofffilter	1	169951
filter water separator Filter Wasserabscheider	1	176434
V-belt Keilriemen	1	172327
filter safety cartridge Filter Sicherheitspatrone	1	167974
filter replacement cartridge Filter Austauschpatrone	1	187692
filter heater Filter Heizung	1	107202
filter heater, outside Filter Heizung (außen)	1	107060
ventilation filter Belüftungsfilter	1	153955
leakage oil filter Leckölfilter	1	027376
auxiliary control filter Vorsteuerfilter	1	150308
line filter Speisedruckfilter	1	154947
return flow filter Rücklauffilter	1	150307
filter crankcase ventilation Filter Kurbelgehäuseentlüftung	1	169954
219478 service package (2000 h) / Service-Paket (2000 h) 818E, 821E (QSB 4.5 Tier 4f / IV, HC)		
engine oil filter Motorölfilter	1	106924
fuel filter Kraftstofffilter	1	169951

Description / Bezeichnung	Qty. / St.	No. / Nr.
filter water separator Filter Wasserabscheider	1	176434
V-belt Keilriemen	1	172327
filter safety cartridge Filter Sicherheitspatrone	1	167974
filter replacement cartridge Filter Austauschpatrone	1	187692
filter heater Filter Heizung	1	107202
filter heater, outside Filter Heizung (außen)	1	107060
ventilation filter Belüftungsfilter	1	153955
leakage oil filter Leckölfilter	1	027376
HydroClean HydroClean	1	150309
line filter Speisedruckfilter	1	154947
return flow filter Rücklauffilter	1	150307
filter crankcase ventilation Filter Kurbelgehäuseentlüftung	1	169954
181062 service package (2000 h) / Service-Paket (2000 h) 825D, 830D (QSB 6.7 Tier 3 / IIIA, VF, WA)		
return flow filter Rücklauffilter	2	150307
leakage oil filter Leckölfilter	1	027376
ventilation filter Belüftungsfilter	1	174541
auxiliary control filter Vorsteuerfilter	1	150308
engine oil filter Motorölfilter	1	106924
fuel filter Kraftstofffilter	1	103142
filter water separator Filter Wasserabscheider	1	103139
filter heater Filter Heizung	1	107202
filter heater, outside Filter Heizung (außen)	1	107060
air filter safety cartridge Sicherheitspatrone Luftfilter	1	064200
air filter replacement cartridge Austauschpatrone Luftfilter	1	118606
V-belt air conditioner Keilriemen Klimaanlage	1	106925
181063 service package (2000 h) / Service-Paket (2000 h) 825D, 830D (QSB 6.7 Tier 3 / IIIA, VF, WAH)		
return flow filter Rücklauffilter	2	150307
leakage oil filter Leckölfilter	1	027376
ventilation filter Belüftungsfilter	1	174541
auxiliary control filter Vorsteuerfilter	1	150308
engine oil filter Motorölfilter	1	106924
fuel filter Kraftstofffilter	1	103142
filter water separator, heatable Filter Wasserabscheider, beheizbar	1	109674
filter heater Filter Heizung	1	107202
filter heater, outside Filter Heizung (außen)	1	107060
air filter safety cartridge Sicherheitspatrone Luftfilter	1	064200
air filter replacement cartridge Austauschpatrone Luftfilter	1	118606
V-belt air conditioner Keilriemen Klimaanlage	1	106925

14.4 SERVICE PACKAGES (2000 H) / SERVICE-PAKETE (2000 H)

Description / Bezeichnung	Qty. / St.	No. / Nr.
181064 service package (2000 h) / Service-Paket (2000 h) 825D, 830D (QSB 6.7 Tier 3 / IIIA, HC, WA)		
return flow filter Rücklaufilter	2	150307
leakage oil filter Lecköfilter	1	027376
ventilation filter Belüftungsfilter	1	174541
HydroClean HydroClean	1	150309
engine oil filter Motoröfilter	1	106924
fuel filter Kraftstofffilter	1	103142
filter water separator Filter Wasserabscheider	1	103139
filter heater Filter Heizung	1	107202
filter heater, outside Filter Heizung (außen)	1	107060
air filter safety cartridge Sicherheitspatrone Luftfilter	1	064200
air filter replacement cartridge Austauschpatrone Luftfilter	1	118606
V-belt air conditioner Keilriemen Klimaanlage	1	106925
181065 service package (2000 h) / Service-Paket (2000 h) 825D, 830D (QSB 6.7 Tier 3 / IIIA, HC, WAH)		
return flow filter Rücklaufilter	2	150307
leakage oil filter Lecköfilter	1	027376
ventilation filter Belüftungsfilter	1	174541
HydroClean HydroClean	1	150309
engine oil filter Motoröfilter	1	106924
fuel filter Kraftstofffilter	1	103142
filter water separator, heatable Filter Wasserabscheider, beheizbar	1	109674
filter heater Filter Heizung	1	107202
filter heater, outside Filter Heizung (außen)	1	107060
air filter safety cartridge Sicherheitspatrone Luftfilter	1	064200
air filter replacement cartridge Austauschpatrone Luftfilter	1	118606
V-belt air conditioner Keilriemen Klimaanlage	1	106925
234011 service package (2000 h) / Service-Paket (2000 h) 825E, 830E (QSB 6.7 Tier 3 / IIIA, VF)		
return flow filter Rücklaufilter	2	150307
leakage oil filter Lecköfilter	1	027376
ventilation filter Belüftungsfilter	1	153955
auxiliary control filter Vorsteuerfilter	1	150308
engine oil filter Motoröfilter	1	106924
fuel filter Kraftstofffilter	1	167975
filter water separator Filter Wasserabscheider	1	158317
filter crankcase ventilation Filter Kurbelgehäuseentlüftung	1	169482
line filter Speisedruckfilter	1	154947
filter heater, inside Filter Heizung, innen	1	107202
filter heater, outside Filter Heizung, außen	1	107060
air filter safety cartridge Sicherheitspatrone Luftfilter	1	167974
air filter replacement cartridge Austauschpatrone Luftfilter	1	167973
V-belt Keilriemen	1	167976
V-belt Keilriemen	1	161492
201823 service package (2000 h) / Service-Paket (2000 h) 830E (bis 830.x.2148, Tier 4i / IIIB, HC)		
return flow filter Rücklaufilter	2	150307
leakage oil filter Lecköfilter	1	027376
ventilation filter Belüftungsfilter	1	153955

Description / Bezeichnung	Qty. / St.	No. / Nr.
air filter replacement cartridge Austauschpatrone Luftfilter	1	167973
V-belt Keilriemen	1	167976
V-belt Keilriemen	1	161492
234012 service package (2000 h) / Service-Paket (2000 h) 825E, 830E (QSB 6.7 Tier 3 / IIIA, HC)		
return flow filter Rücklaufilter	2	150307
leakage oil filter Lecköfilter	1	027376
ventilation filter Belüftungsfilter	1	153955
HydroClean HydroClean	1	150309
engine oil filter Motoröfilter	1	106924
fuel filter Kraftstofffilter	1	103142
filter water separator Filter Wasserabscheider	1	176434
line filter Speisedruckfilter	1	154947
filter heater, inside Filter Heizung, innen	1	107202
filter heater, outside Filter Heizung, außen	1	107060
air filter safety cartridge Sicherheitspatrone Luftfilter	1	167974
air filter replacement cartridge Austauschpatrone Luftfilter	1	167973
V-belt Keilriemen	1	167976
V-belt Keilriemen	1	161492
201822 service package (2000 h) / Service-Paket (2000 h) 830E (bis 830.x.2148, Tier 4i / IIIB, VF)		
return flow filter Rücklaufilter	2	150307
leakage oil filter Lecköfilter	1	027376
ventilation filter Belüftungsfilter	1	153955
auxiliary control filter Vorsteuerfilter	1	150308
engine oil filter Motoröfilter	1	106924
fuel filter Kraftstofffilter	1	167975
filter water separator Filter Wasserabscheider	1	158317
filter crankcase ventilation Filter Kurbelgehäuseentlüftung	1	169482
line filter Speisedruckfilter	1	154947
filter heater, inside Filter Heizung, innen	1	107202
filter heater, outside Filter Heizung, außen	1	107060
air filter safety cartridge Sicherheitspatrone Luftfilter	1	167974
air filter replacement cartridge Austauschpatrone Luftfilter	1	167973
V-belt Keilriemen	1	167976
V-belt Keilriemen	1	161492
201823 service package (2000 h) / Service-Paket (2000 h) 830E (bis 830.x.2148, Tier 4i / IIIB, HC)		
return flow filter Rücklaufilter	2	150307
leakage oil filter Lecköfilter	1	027376
ventilation filter Belüftungsfilter	1	153955

Description / Bezeichnung	Qty. / St.	No. / Nr.
HydroClean HydroClean	1	150309
engine oil filter Motoröfilter	1	106924
fuel filter Kraftstofffilter	1	167975
filter water separator Filter Wasserabscheider	1	158317
filter crankcase ventilation Filter Kurbelgehäuseentlüftung	1	169482
line filter Speisedruckfilter	1	154947
filter heater, inside Filter Heizung, innen	1	107202
filter heater, outside Filter Heizung, außen	1	107060
air filter safety cartridge Sicherheitspatrone Luftfilter	1	167974
air filter replacement cartridge Austauschpatrone Luftfilter	1	167973
V-belt Keilriemen	1	167976
V-belt Keilriemen	1	161492
180992 service package (2000 h) / Service-Paket (2000 h) 830E (QSB 6.7 Tier 4i / IIIB, VF)		
return flow filter Rücklaufilter	2	150307
leakage oil filter Lecköfilter	1	027376
ventilation filter Belüftungsfilter	1	153955
auxiliary control filter Vorsteuerfilter	1	150308
engine oil filter Motoröfilter	1	106924
fuel filter Kraftstofffilter	1	167975
filter water separator Filter Wasserabscheider	1	158317
filter crankcase ventilation Filter Kurbelgehäuseentlüftung	1	169482
line filter Speisedruckfilter	1	154947
filter heater Filter Heizung	1	107202
filter heater, outside Filter Heizung (außen)	1	107060
filter safety cartridge Filter Sicherheitspatrone	1	167974
filter replacement cartridge Filter Austauschpatrone	1	167973
V-belt Keilriemen	1	167976
V-belt air conditioner Keilriemen Klimaanlage	1	161492
180993 service package (2000 h) / Service-Paket (2000 h) 830E (QSB 6.7 Tier 4i / IIIB, HC)		
return flow filter Rücklaufilter	2	150307
leakage oil filter Lecköfilter	1	027376
ventilation filter Belüftungsfilter	1	153955
HydroClean HydroClean	1	150309
engine oil filter Motoröfilter	1	106924
fuel filter Kraftstofffilter	1	167975
filter water separator Filter Wasserabscheider	1	158317
filter crankcase ventilation Filter Kurbelgehäuseentlüftung	1	169482
line filter Speisedruckfilter	1	154947

14.4 SERVICE PACKAGES (2000 H) / SERVICE-PAKETE (2000 H)

Description / Bezeichnung	Qty. / St.	No. / Nr.
filter heater Filter Heizung	1	107202
filter heater, outside Filter Heizung (außen)	1	107060
filter safety cartridge Filter Sicherheitspatrone	1	167974
filter replacement cartridge Filter Austauschpatrone	1	167973
V-belt Keilriemen	1	167976
V-belt air conditioner Keilriemen Klimaanlage	1	161492
198392 service package (2000 h) / Service-Paket (2000 h) 825E, 830E (QSB 6.7 Tier 4f / IV, VF)		
return flow filter Rücklauffilter	2	150307
leakage oil filter Leckölfilter	1	027376
ventilation filter Belüftungsfilter	1	153955
auxiliary control filter Vorsteuerfilter	1	150308
engine oil filter Motorölfilter	1	106924
fuel filter Kraftstofffilter	1	169951
filter water separator Filter Wasserabscheider	1	176434
filter crankcase ventilation Filter Kurbelgehäuseentlüftung	1	169482
line filter Speisedruckfilter	1	154947
filter heater Filter Heizung	1	107202
filter heater, outside Filter Heizung (außen)	1	107060
filter safety cartridge Filter Sicherheitspatrone	1	167974
filter replacement cartridge Filter Austauschpatrone	1	167973
V-belt Keilriemen	1	167976
V-belt air conditioner Keilriemen Klimaanlage	1	161492
198393 service package (2000 h) / Service-Paket (2000 h) 825E, 830E (QSB 6.7 Tier 4f / IV, HC)		
return flow filter Rücklauffilter	2	150307
leakage oil filter Leckölfilter	1	027376
ventilation filter Belüftungsfilter	1	153955
HydroClean HydroClean	1	150309
engine oil filter Motorölfilter	1	106924
fuel filter Kraftstofffilter	1	169951
filter water separator Filter Wasserabscheider	1	176434
filter crankcase ventilation Filter Kurbelgehäuseentlüftung	1	169482
line filter Speisedruckfilter	1	154947
filter heater Filter Heizung	1	107202
filter heater, outside Filter Heizung (außen)	1	107060
filter safety cartridge Filter Sicherheitspatrone	1	167974
filter replacement cartridge Filter Austauschpatrone	1	167973
V-belt Keilriemen	1	167976
V-belt air conditioner Keilriemen Klimaanlage	1	161492

Description / Bezeichnung	Qty. / St.	No. / Nr.
247945 service package (2000 h) / Service-Paket (2000 h) 825E, 830E (B 6.7 EU Stage V, VF)		
return flow filter Rücklauffilter	2	150307
leakage oil filter Leckölfilter	1	027376
ventilation filter Belüftungsfilter	1	153955
auxiliary control filter Vorsteuerfilter	1	150308
breather filter Entlüftungsfilter	1	168306
engine oil filter Motorölfilter	1	106924
fuel filter Kraftstofffilter	1	169951
filter water separator Filter Wasserabscheider	1	176434
air filter safety cartridge Sicherheitspatrone Luftfilter	1	167974
air filter replacement cartridge Austauschpatrone Luftfilter	1	167973
V-belt Keilriemen	1	167976
V-belt Keilriemen	1	161492
line filter Speisedruckfilter	1	154947
suction filter Ansaugfilter	1	205787
filter heater, inside Filter Heizung, innen	1	107202
filter heater, outside Filter Heizung, außen	1	107060
247944 service package (2000 h) / Service-Paket (2000 h) 825E, 830E (B 6.7 EU Stage V, HC)		
return flow filter Rücklauffilter	2	150307
leakage oil filter Leckölfilter	1	027376
ventilation filter Belüftungsfilter	1	153955
HydroClean HydroClean	1	150309
breather filter Entlüftungsfilter	1	168306
engine oil filter Motorölfilter	1	106924
fuel filter Kraftstofffilter	1	169951
filter water separator Filter Wasserabscheider	1	176434
air filter safety cartridge Sicherheitspatrone Luftfilter	1	167974
air filter replacement cartridge Austauschpatrone Luftfilter	1	167973
filter heater, inside Filter Heizung, innen	1	107202
filter heater, outside Filter Heizung, außen	1	107060
V-belt Keilriemen	1	167976
V-belt Keilriemen	1	161492
line filter Speisedruckfilter	1	154947
suction filter Ansaugfilter	1	205787
181066 service package (2000 h) / Service-Paket (2000 h) 835D, 840D (QSB 6.7 Tier 3 / IIIA, VF, WA)		
return flow filter Rücklauffilter	2	150307
leakage oil filter Leckölfilter	1	027376
ventilation filter Belüftungsfilter	1	174541

Description / Bezeichnung	Qty. / St.	No. / Nr.
auxiliary control filter Vorsteuerfilter	1	150308
engine oil filter Motorölfilter	1	106924
fuel filter Kraftstofffilter	1	103142
filter water separator Filter Wasserabscheider	1	103139
filter heater Filter Heizung	1	107202
filter heater, outside Filter Heizung (außen)	1	107060
air filter safety cartridge Sicherheitspatrone Luftfilter	1	068827
air filter replacement cartridge Austauschpatrone Luftfilter	1	068826
V-belt air conditioner Keilriemen Klimaanlage	1	106925
181067 service package (2000 h) / Service-Paket (2000 h) 835D, 840D (QSB 6.7 Tier 3 / IIIA, VF, WAH)		
return flow filter Rücklauffilter	2	150307
leakage oil filter Leckölfilter	1	027376
ventilation filter Belüftungsfilter	1	174541
auxiliary control filter Vorsteuerfilter	1	150308
engine oil filter Motorölfilter	1	106924
fuel filter Kraftstofffilter	1	103142
filter water separator, heatable Filter Wasserabscheider, beheizbar	1	109674
filter heater Filter Heizung	1	107202
filter heater, outside Filter Heizung (außen)	1	107060
air filter safety cartridge Sicherheitspatrone Luftfilter	1	068827
air filter replacement cartridge Austauschpatrone Luftfilter	1	068826
V-belt air conditioner Keilriemen Klimaanlage	1	106925
181068 service package (2000 h) / Service-Paket (2000 h) 835D, 840D (QSB 6.7 Tier 3 / IIIA, HC, WA)		
return flow filter Rücklauffilter	2	150307
leakage oil filter Leckölfilter	1	027376
ventilation filter Belüftungsfilter	1	174541
HydroClean HydroClean	1	150309
engine oil filter Motorölfilter	1	106924
fuel filter Kraftstofffilter	1	103142
filter water separator Filter Wasserabscheider	1	103139
filter heater Filter Heizung	1	107202
filter heater, outside Filter Heizung (außen)	1	107060
air filter safety cartridge Sicherheitspatrone Luftfilter	1	068827
air filter replacement cartridge Austauschpatrone Luftfilter	1	068826
V-belt air conditioner Keilriemen Klimaanlage	1	106925

14.4 SERVICE PACKAGES (2000 H) / SERVICE-PAKETE (2000 H)

Description / Bezeichnung	Qty. / St.	No. / Nr.
181069 service package (2000 h) / Service-Paket (2000 h) 835D, 840D (QSB 6.7 Tier 3 / IIIA, HC, WAH)		
return flow filter Rücklauffilter	2	150307
leakage oil filter Lecköfilter	1	027376
ventilation filter Belüftungsfilter	1	174541
HydroClean HydroClean	1	150309
engine oil filter Motorölfilter	1	106924
fuel filter Kraftstofffilter	1	103142
filter water separator, heatable Filter Wasserabscheider, beheizbar	1	109674
filter heater Filter Heizung	1	107202
filter heater, outside Filter Heizung (außen)	1	107060
air filter safety cartridge Sicherheitspatrone Luftfilter	1	068827
air filter replacement cartridge Austauschpatrone Luftfilter	1	068826
V-belt air conditioner Keilriemen Klimaanlage	1	106925
252386 service package (2000 h) / Service-Paket (2000 h) 835E (QSL9 Tier 3 / IIIA, VF)		
return flow filter Rücklauffilter	1	151945
leakage oil filter Lecköfilter	1	027376
ventilation filter Belüftungsfilter	1	153955
breather filter Entlüftungsfilter	1	168306
auxiliary control filter Vorsteuerfilter	1	150308
engine oil filter Motorölfilter	1	157835
fuel filter Kraftstofffilter	1	189578
filter water separator Filter Wasserabscheider	1	176434
air filter safety cartridge Sicherheitspatrone Luftfilter	1	205231
air filter replacement cartridge Austauschpatrone Luftfilter	1	205230
V-belt Keilriemen	1	081733
V-belt Keilriemen	1	189579
filter heater, outside Filter Heizung, außen	1	107060
filter heater, inside Filter Heizung, innen	1	107202
line filter Speisedruckfilter	1	154947
water filter Kühlwasserfilter	1	158319
252387 service package (2000 h) / Service-Paket (2000 h) 835E (QSL9 Tier 3 / IIIA, HC)		
return flow filter Rücklauffilter	1	151945
leakage oil filter Lecköfilter	1	027376
ventilation filter Belüftungsfilter	1	153955
breather filter Entlüftungsfilter	1	168306
HydroClean HydroClean	1	150309
engine oil filter Motorölfilter	1	157835
fuel filter Kraftstofffilter	1	189578
filter water separator Filter Wasserabscheider	1	176434

Description / Bezeichnung	Qty. / St.	No. / Nr.
air filter safety cartridge Sicherheitspatrone Luftfilter	1	205231
air filter replacement cartridge Austauschpatrone Luftfilter	1	205230
V-belt Keilriemen	1	081733
V-belt Keilriemen	1	189579
filter heater, outside Filter Heizung, außen	1	107060
filter heater, inside Filter Heizung, innen	1	107202
line filter Speisedruckfilter	1	154947
water filter Kühlwasserfilter	1	158319
180996 service package (2000 h) / Service-Paket (2000 h) 835E, 840E (QSL 9 Tier 4i / IIIB, VF)		
return flow filter Rücklauffilter	1	151945
leakage oil filter Lecköfilter	1	027376
ventilation filter Belüftungsfilter	1	153955
auxiliary control filter Vorsteuerfilter	1	150308
engine oil filter Motorölfilter	1	157835
fuel filter Kraftstofffilter	1	158318
filter water separator Filter Wasserabscheider	1	158317
water filter Kühlwasserfilter	1	158319
filter crankcase ventilation Filter Kurbelgehäuseentlüftung	1	169483
line filter Speisedruckfilter	1	154947
filter heater Filter Heizung	1	107202
filter heater, outside Filter Heizung (außen)	1	107060
filter safety cartridge Filter Sicherheitspatrone	1	157839
filter replacement cartridge Filter Austauschpatrone	1	157840
V-belt fan Keilriemen Lüfter	1	158322
V-belt air conditioner Keilriemen Klimaanlage	1	081733
180995 service package (2000 h) / Service-Paket (2000 h) 835E, 840E (QSL 9 Tier 4i / IIIB, HC)		
return flow filter Rücklauffilter	1	151945
leakage oil filter Lecköfilter	1	027376
ventilation filter Belüftungsfilter	1	153955
HydroClean HydroClean	1	150309
engine oil filter Motorölfilter	1	157835
fuel filter Kraftstofffilter	1	158318
filter water separator Filter Wasserabscheider	1	158317
water filter Kühlwasserfilter	1	158319
filter crankcase ventilation Filter Kurbelgehäuseentlüftung	1	169483
line filter Speisedruckfilter	1	154947
filter heater Filter Heizung	1	107202
filter heater, outside Filter Heizung (außen)	1	107060
filter safety cartridge Filter Sicherheitspatrone	1	157839

Description / Bezeichnung	Qty. / St.	No. / Nr.
filter replacement cartridge Filter Austauschpatrone	1	157840
V-belt fan Keilriemen Lüfter	1	158322
V-belt air conditioner Keilriemen Klimaanlage	1	081733
187499 service package (2000 h) / Service-Paket (2000 h) 835E, 840E (QSL 9 Tier 4f / IV, VF)		
return flow filter Rücklauffilter	1	151945
leakage oil filter Lecköfilter	1	027376
ventilation filter Belüftungsfilter	1	153955
auxiliary control filter Vorsteuerfilter	1	150308
engine oil filter Motorölfilter	1	157835
fuel filter Kraftstofffilter	1	169951
filter water separator Filter Wasserabscheider	1	176434
water filter Kühlwasserfilter	1	158319
filter crankcase ventilation Filter Kurbelgehäuseentlüftung	1	169483
line filter Speisedruckfilter	1	154947
filter heater Filter Heizung	1	107202
filter heater, outside Filter Heizung (außen)	1	107060
filter safety cartridge Filter Sicherheitspatrone	1	157839
filter replacement cartridge Filter Austauschpatrone	1	157840
V-belt fan Keilriemen Lüfter	1	158322
V-belt air conditioner Keilriemen Klimaanlage	1	081733
187500 service package (2000 h) / Service-Paket (2000 h) 835E, 840E (QSL 9 Tier 4f / IV, HC)		
return flow filter Rücklauffilter	1	151945
leakage oil filter Lecköfilter	1	027376
ventilation filter Belüftungsfilter	1	153955
HydroClean HydroClean	1	150309
engine oil filter Motorölfilter	1	157835
fuel filter Kraftstofffilter	1	169951
filter water separator Filter Wasserabscheider	1	176434
water filter Kühlwasserfilter	1	158319
filter crankcase ventilation Filter Kurbelgehäuseentlüftung	1	169483
line filter Speisedruckfilter	1	154947
filter heater Filter Heizung	1	107202
filter heater, outside Filter Heizung (außen)	1	107060
filter safety cartridge Filter Sicherheitspatrone	1	157839
filter replacement cartridge Filter Austauschpatrone	1	157840
V-belt fan Keilriemen Lüfter	1	158322
V-belt air conditioner Keilriemen Klimaanlage	1	081733

14.4 SERVICE PACKAGES (2000 H) / SERVICE-PAKETE (2000 H)

Description / Bezeichnung	Qty. / St.	No. / Nr.
249528 service package (2000 h) / Service-Paket (2000 h) 835E, 840E (L9 EU Stage V, VF)		
return flow filter Rücklauffilter	1	151945
leakage oil filter Leckölfilter	1	027376
ventilation filter Belüftungsfilter	1	153955
auxiliary control filter Vorsteuerfilter	1	150308
line filter Speisedruckfilter	1	154947
breather filter Entlüftungsfilter	1	168306
engine oil filter Motorölfilter	1	244361
fuel filter Kraftstofffilter	1	169951
filter water separator Filter Wasserabscheider	1	176434
water filter Kühlwasserfilter	1	158319
filter heater, outside Filter Heizung, außen	1	107060
filter heater, inside Filter Heizung, innen	1	107202
air filter safety cartridge Sicherheitspatrone Luftfilter	2	205231
air filter replacement cartridge Austauschpatrone Luftfilter	2	205230
V-belt Keilriemen	1	081733
V-belt Keilriemen	1	158322
249527 service package (2000 h) / Service-Paket (2000 h) 835E, 840E (L9 EU Stage V, HC)		
return flow filter Rücklauffilter	1	151945
leakage oil filter Leckölfilter	1	027376
ventilation filter Belüftungsfilter	1	153955
HydroClean HydroClean	1	150309
line filter Speisedruckfilter	1	154947
breather filter Entlüftungsfilter	1	168306
engine oil filter Motorölfilter	1	244361
fuel filter Kraftstofffilter	1	169951
filter water separator Filter Wasserabscheider	1	176434
water filter Kühlwasserfilter	1	158319
filter heater, outside Filter Heizung, außen	1	107060
filter heater, inside Filter Heizung, innen	1	107202
air filter safety cartridge Sicherheitspatrone Luftfilter	2	205231
air filter replacement cartridge Austauschpatrone Luftfilter	2	205230
V-belt Keilriemen	1	081733
V-belt Keilriemen	1	158322
181070 service package (2000 h) / Service-Paket (2000 h) 850D, 860D (QSM 11 Tier 3 / IIIA, VF, WA)		
return flow filter Rücklauffilter	3	150307
leakage oil filter Leckölfilter	1	027376
ventilation filter Belüftungsfilter	2	174541
auxiliary control filter Vorsteuerfilter	1	150308

Description / Bezeichnung	Qty. / St.	No. / Nr.
pressure filter Druckfilter	1	154933
engine oil filter Motorölfilter	1	189624
water filter Kühlwasserfilter	1	136896
fuel filter Kraftstofffilter	1	136897
filter water separator Filter Wasserabscheider	1	103139
filter heater Filter Heizung	1	107202
filter heater, outside Filter Heizung (außen)	1	107060
air filter safety cartridge Sicherheitspatrone Luftfilter	1	068827
air filter replacement cartridge Austauschpatrone Luftfilter	1	068826
V-belt alternator Keilriemen Lichtmaschine	1	132595
V-belt alternator Keilriemen Lichtmaschine	1	132596
181071 service package (2000 h) / Service-Paket (2000 h) 850D, 860D (QSM 11 Tier 3 / IIIA, VF, WAH)		
return flow filter Rücklauffilter	3	150307
leakage oil filter Leckölfilter	1	027376
ventilation filter Belüftungsfilter	2	174541
auxiliary control filter Vorsteuerfilter	1	150308
pressure filter Druckfilter	1	154933
engine oil filter Motorölfilter	1	189624
water filter Kühlwasserfilter	1	136896
fuel filter Kraftstofffilter	1	136897
filter water separator Filter Wasserabscheider	1	165338
filter heater Filter Heizung	1	107202
filter heater, outside Filter Heizung (außen)	1	107060
air filter safety cartridge Sicherheitspatrone Luftfilter	1	068827
air filter replacement cartridge Austauschpatrone Luftfilter	1	068826
V-belt alternator Keilriemen Lichtmaschine	1	132595
V-belt alternator Keilriemen Lichtmaschine	1	132596
181072 service package (2000 h) / Service-Paket (2000 h) 850D, 860D (QSM 11 Tier 3 / IIIA, HC, WA)		
return flow filter Rücklauffilter	3	150307
leakage oil filter Leckölfilter	1	027376
ventilation filter Belüftungsfilter	2	174541
HydroClean HydroClean	1	150309
pressure filter Druckfilter	1	154933
engine oil filter Motorölfilter	1	189624
water filter Kühlwasserfilter	1	136896
fuel filter Kraftstofffilter	1	136897
filter water separator Filter Wasserabscheider	1	103139
filter heater Filter Heizung	1	107202
filter heater, outside Filter Heizung (außen)	1	107060

Description / Bezeichnung	Qty. / St.	No. / Nr.
air filter safety cartridge Sicherheitspatrone Luftfilter	1	068827
air filter replacement cartridge Austauschpatrone Luftfilter	1	068826
V-belt alternator Keilriemen Lichtmaschine	1	132595
V-belt alternator Keilriemen Lichtmaschine	1	132596
181073 service package (2000 h) / Service-Paket (2000 h) 850D, 860D (QSM 11 Tier 3 / IIIA, HC, WAH)		
return flow filter Rücklauffilter	3	150307
leakage oil filter Leckölfilter	1	027376
ventilation filter Belüftungsfilter	2	174541
HydroClean HydroClean	1	150309
pressure filter Druckfilter	1	154933
engine oil filter Motorölfilter	1	189624
water filter Kühlwasserfilter	1	136896
fuel filter Kraftstofffilter	1	136897
filter water separator Filter Wasserabscheider	1	165338
filter heater Filter Heizung	1	107202
filter heater, outside Filter Heizung (außen)	1	107060
air filter safety cartridge Sicherheitspatrone Luftfilter	1	068827
air filter replacement cartridge Austauschpatrone Luftfilter	1	068826
V-belt alternator Keilriemen Lichtmaschine	1	132595
V-belt alternator Keilriemen Lichtmaschine	1	132596
181080 service package (2000 h) / Service-Paket (2000 h) 870C (TCD 15 Tier 3 / IIIA, VF)		
return flow filter Rücklauffilter	3	150307
leakage oil filter Leckölfilter	1	027376
ventilation filter Belüftungsfilter	2	057228
auxiliary control filter Vorsteuerfilter	1	150308
engine oil filter Motorölfilter	1	179462
fuel filter Kraftstofffilter	2	089014
filter water separator Filter Wasserabscheider	1	148781
filter heater Filter Heizung	1	107202
filter heater, outside Filter Heizung (außen)	1	107060
air filter safety cartridge Sicherheitspatrone Luftfilter	1	068827
air filter replacement cartridge Austauschpatrone Luftfilter	1	068826
V-belt alternator Keilriemen Lichtmaschine	1	080188
V-belt air conditioner Keilriemen Klimaanlage	1	032090

14.4 SERVICE PACKAGES (2000 H) / SERVICE-PAKETE (2000 H)

Description / Bezeichnung	Qty. / St.	No. / Nr.
181081 service package (2000 h) / Service-Paket (2000 h) 870C (TCD 15 Tier 3 / IIIA, HC)		
return flow filter Rücklauffilter	3	150307
leakage oil filter Leckölfilter	1	027376
ventilation filter Belüftungsfilter	2	057228
HydroClean HydroClean	1	150309
engine oil filter Motorölfilter	1	179462
fuel filter Kraftstofffilter	2	089014
filter water separator Filter Wasserabscheider	1	148781
filter heater Filter Heizung	1	107202
filter heater, outside Filter Heizung (außen)	1	107060
air filter safety cartridge Sicherheitspatrone Luftfilter	1	068827
air filter replacement cartridge Austauschpatrone Luftfilter	1	068826
V-belt alternator Keilriemen Lichtmaschine	1	080188
V-belt air conditioner Keilriemen Klimaanlage	1	032090
187029 service package (2000 h) / Service-Paket (2000 h) 875E (QSX 15 Tier 4i / IIIB)		
leakage oil filter Leckölfilter	2	027376
filter heater, outside Filter Heizung (außen)	1	107060
filter heater Filter Heizung	1	107202
engine oil filter Motorölfilter	1	189624
auxiliary control filter Vorsteuerfilter	2	150308
HydroClean HydroClean	1	150309
return flow filter Rücklauffilter	2	151945
ventilation filter Belüftungsfilter	2	153955
pressure filter Druckfilter	2	154936
pressure filter Druckfilter	1	154938
filter replacement cartridge Filter Austauschpatrone	1	167973
filter safety cartridge Filter Sicherheitspatrone	1	167974
V-belt Keilriemen	1	170212
filter water separator Filter Wasserabscheider	1	176434
fuel filter Kraftstofffilter	1	189623
182557 service package (2000 h) / Service-Paket (2000 h) 608, 613D (TCD 12 Tier 3 / IIIA, VF, WA)		
return flow filter Rücklauffilter	1	150307
leakage oil filter Leckölfilter	1	027376
ventilation filter Belüftungsfilter	1	057228
auxiliary control filter Vorsteuerfilter	1	150308
pressure filter Druckfilter	1	205125
engine oil filter Motorölfilter	1	080543

Description / Bezeichnung	Qty. / St.	No. / Nr.
fuel filter Kraftstofffilter	1	106109
filter water separator Filter Wasserabscheider	1	147645
filter air conditioner Filter Klimaanlage	1	138361
air filter safety cartridge Sicherheitspatrone Luftfilter	1	072385
air filter replacement cartridge Austauschpatrone Luftfilter	1	072386
V-belt alternator Keilriemen Lichtmaschine	1	108048
187033 service package (2000 h) / Service-Paket (2000 h) 608, 613D (TCD 12 Tier 3 / IIIA, VF, WAH)		
return flow filter Rücklauffilter	1	150307
leakage oil filter Leckölfilter	1	027376
ventilation filter Belüftungsfilter	1	057228
auxiliary control filter Vorsteuerfilter	1	150308
pressure filter Druckfilter	1	205125
engine oil filter Motorölfilter	1	080543
fuel filter Kraftstofffilter	1	106109
filter water separator, heatable Filter Wasserabscheider, beheizbar	1	096151
filter air conditioner Filter Klimaanlage	1	138361
air filter safety cartridge Sicherheitspatrone Luftfilter	1	072385
air filter replacement cartridge Austauschpatrone Luftfilter	1	072386
V-belt alternator Keilriemen Lichtmaschine	1	108048
182558 service package (2000 h) / Service-Paket (2000 h) 608, 613D (TCD 12 Tier 3 / IIIA, HC, WA)		
return flow filter Rücklauffilter	1	150307
leakage oil filter Leckölfilter	1	027376
ventilation filter Belüftungsfilter	1	057228
HydroClean HydroClean	1	150309
pressure filter Druckfilter	1	205125
engine oil filter Motorölfilter	1	080543
fuel filter Kraftstofffilter	1	106109
filter water separator Filter Wasserabscheider	1	147645
filter air conditioner Filter Klimaanlage	1	138361
air filter safety cartridge Sicherheitspatrone Luftfilter	1	072385
air filter replacement cartridge Austauschpatrone Luftfilter	1	072386
V-belt alternator Keilriemen Lichtmaschine	1	108048
187034 service package (2000 h) / Service-Paket (2000 h) 608, 613D (TCD 12 Tier 3 / IIIA, HC, WAH)		
return flow filter Rücklauffilter	1	150307
leakage oil filter Leckölfilter	1	027376
ventilation filter Belüftungsfilter	1	057228
HydroClean HydroClean	1	150309

Description / Bezeichnung	Qty. / St.	No. / Nr.
pressure filter Druckfilter	1	205125
engine oil filter Motorölfilter	1	080543
fuel filter Kraftstofffilter	1	106109
filter water separator, heatable Filter Wasserabscheider, beheizbar	1	096151
filter air conditioner Filter Klimaanlage	1	138361
air filter safety cartridge Sicherheitspatrone Luftfilter	1	072385
air filter replacement cartridge Austauschpatrone Luftfilter	1	072386
V-belt alternator Keilriemen Lichtmaschine	1	108048
238435 service package (2000 h) / Service-Paket (2000 h) 613E (FPT NEF 45 Tier 3 / IIIA, VF)		
return flow filter Rücklauffilter	1	150307
leakage oil filter Leckölfilter	1	063580
ventilation filter Belüftungsfilter	1	153955
breather filter Entlüftungsfilter	1	168306
auxiliary control filter Vorsteuerfilter	1	150308
engine oil filter Motorölfilter	1	206076
fuel filter Kraftstofffilter	1	103142
filter water separator Filter Wasserabscheider	1	176434
filter air conditioner Filter Klimaanlage	1	138361
air filter safety cartridge Sicherheitspatrone Luftfilter	1	149255
air filter replacement cartridge Austauschpatrone Luftfilter	1	149256
V-belt Keilriemen	1	206172
V-belt Keilriemen	1	206782
238436 service package (2000 h) / Service-Paket (2000 h) 613E (FPT NEF 45 Tier 3 / IIIA, HC)		
return flow filter Rücklauffilter	1	150307
leakage oil filter Leckölfilter	1	063580
ventilation filter Belüftungsfilter	1	153955
breather filter Entlüftungsfilter	1	168306
HydroClean HydroClean	1	150309
engine oil filter Motorölfilter	1	206076
fuel filter Kraftstofffilter	1	103142
filter water separator Filter Wasserabscheider	1	176434
filter air conditioner Filter Klimaanlage	1	138361
air filter safety cartridge Sicherheitspatrone Luftfilter	1	149255
air filter replacement cartridge Austauschpatrone Luftfilter	1	149256
V-belt Keilriemen	1	206172
V-belt Keilriemen	1	206782

14.4 SERVICE PACKAGES (2000 H) / SERVICE-PAKETE (2000 H)

Description / Bezeichnung	Qty. / St.	No. / Nr.
225362 service package (2000 h) / Service-Paket (2000 h) 613E (FPT NEF 45 Tier 4f / IV, VF)		
engine oil filter <i>Motorölfilter</i>	1	206076
fuel filter <i>Kraftstofffilter</i>	1	103142
fuel filter <i>Kraftstofffilter</i>	1	206184
filter crankcase ventilation <i>Filter Kurbelgehäuseentlüftung</i>	1	206075
V-belt <i>Keilriemen</i>	1	206172
V-belt <i>Keilriemen</i>	1	206782
seal <i>Ventildeckeldichtung</i>	1	206177
filter safety cartridge <i>Filter Sicherheitspatrone</i>	1	149255
filter replacement cartridge <i>Filter Austauschpatrone</i>	1	149256
auxiliary control filter <i>Vorsteuerfilter</i>	1	150308
return flow filter <i>Rücklauffilter</i>	2	150307
leakage oil filter <i>Leckölfilter</i>	1	027376
breather filter <i>Entlüftungsfilter</i>	1	168306
ventilation filter <i>Belüftungsfilter</i>	1	153955
filter heater <i>Filter Heizung</i>	1	107202
filter heater, outside <i>Filter Heizung (außen)</i>	1	107060
225366 service package (2000 h) / Service-Paket (2000 h) 613E (FPT NEF 45 Tier 4f / IV, HC)		
engine oil filter <i>Motorölfilter</i>	1	206076
fuel filter <i>Kraftstofffilter</i>	1	103142
fuel filter <i>Kraftstofffilter</i>	1	206184
filter crankcase ventilation <i>Filter Kurbelgehäuseentlüftung</i>	1	206075
V-belt <i>Keilriemen</i>	1	206172
V-belt <i>Keilriemen</i>	1	206782
seal <i>Ventildeckeldichtung</i>	1	206177
filter safety cartridge <i>Filter Sicherheitspatrone</i>	1	149255
filter replacement cartridge <i>Filter Austauschpatrone</i>	1	149256
auxiliary control filter <i>Vorsteuerfilter</i>	1	150309
return flow filter <i>Rücklauffilter</i>	2	150307
leakage oil filter <i>Leckölfilter</i>	1	027376
breather filter <i>Entlüftungsfilter</i>	1	168306
ventilation filter <i>Belüftungsfilter</i>	1	153955
filter heater <i>Filter Heizung</i>	1	107202
filter heater, outside <i>Filter Heizung (außen)</i>	1	107060

Description / Bezeichnung	Qty. / St.	No. / Nr.
236483 service package (2000 h) / Service-Paket (2000 h) 633E (QSB 4.5 Tier 3 / IIIA, VF)		
return flow filter <i>Rücklauffilter</i>	1	150307
leakage oil filter <i>Leckölfilter</i>	1	063580
ventilation filter <i>Belüftungsfilter</i>	1	153955
breather filter <i>Entlüftungsfilter</i>	1	168306
auxiliary control filter <i>Vorsteuerfilter</i>	1	150308
engine oil filter <i>Motorölfilter</i>	1	106924
fuel filter <i>Kraftstofffilter</i>	1	103142
filter water separator <i>Filter Wasserabscheider</i>	1	176434
filter air conditioner <i>Filter Klimaanlage</i>	1	138361
air filter safety cartridge <i>Sicherheitspatrone Luftfilter</i>	1	064200
air filter replacement cartridge <i>Austauschpatrone Luftfilter</i>	1	118606
power belt <i>Kraftband</i>	1	116125
236484 service package (2000 h) / Service-Paket (2000 h) 633E (QSB 4.5 Tier 3 / IIIA, HC)		
return flow filter <i>Rücklauffilter</i>	1	150307
leakage oil filter <i>Leckölfilter</i>	1	063580
ventilation filter <i>Belüftungsfilter</i>	1	153955
breather filter <i>Entlüftungsfilter</i>	1	168306
HydroClean <i>HydroClean</i>	1	150309
engine oil filter <i>Motorölfilter</i>	1	106924
fuel filter <i>Kraftstofffilter</i>	1	103142
filter water separator <i>Filter Wasserabscheider</i>	1	176434
filter air conditioner <i>Filter Klimaanlage</i>	1	138361
air filter safety cartridge <i>Sicherheitspatrone Luftfilter</i>	1	064200
air filter replacement cartridge <i>Austauschpatrone Luftfilter</i>	1	118606
power belt <i>Kraftband</i>	1	116125
182561 service package / Service-Paket (2000 h) 643 (TCD 12 Tier 3 / IIIA, VF, WA)		
return flow filter <i>Rücklauffilter</i>	1	150307
leakage oil filter <i>Leckölfilter</i>	1	027376
ventilation filter <i>Belüftungsfilter</i>	1	057228
auxiliary control filter <i>Vorsteuerfilter</i>	1	150308
engine oil filter <i>Motorölfilter</i>	1	027026
fuel filter <i>Kraftstofffilter</i>	2	084776
filter water separator <i>Filter Wasserabscheider</i>	1	147645
filter heater <i>Filter Heizung</i>	1	107202
filter heater, outside <i>Filter Heizung (außen)</i>	1	107060
air filter safety cartridge <i>Sicherheitspatrone Luftfilter</i>	1	100719
air filter replacement cartridge <i>Austauschpatrone Luftfilter</i>	1	100720
V-belt alternator <i>Keilriemen Lichtmaschine</i>	1	082454
V-belt water pump <i>Keilriemen Wasserpumpe</i>	1	080542
V-belt air conditioner <i>Keilriemen Klimaanlage</i>	1	084264

Description / Bezeichnung	Qty. / St.	No. / Nr.
air filter safety cartridge <i>Sicherheitspatrone Luftfilter</i>	1	100719
air filter replacement cartridge <i>Austauschpatrone Luftfilter</i>	1	100720
V-belt alternator <i>Keilriemen Lichtmaschine</i>	1	082454
V-belt water pump <i>Keilriemen Wasserpumpe</i>	1	080542
V-belt air conditioner <i>Keilriemen Klimaanlage</i>	1	084264
187037 service package (2000 h) / Service-Paket (2000 h) 643 (TCD 12 Tier 3 / IIIA, VF, WAH)		
return flow filter <i>Rücklauffilter</i>	1	150307
leakage oil filter <i>Leckölfilter</i>	1	027376
ventilation filter <i>Belüftungsfilter</i>	1	057228
auxiliary control filter <i>Vorsteuerfilter</i>	1	150308
engine oil filter <i>Motorölfilter</i>	1	027026
fuel filter <i>Kraftstofffilter</i>	2	084776
filter water separator, heatable <i>Filter Wasserabscheider, beheizbar</i>	1	096151
filter heater <i>Filter Heizung</i>	1	107202
filter heater, outside <i>Filter Heizung (außen)</i>	1	107060
air filter safety cartridge <i>Sicherheitspatrone Luftfilter</i>	1	100719
air filter replacement cartridge <i>Austauschpatrone Luftfilter</i>	1	100720
V-belt alternator <i>Keilriemen Lichtmaschine</i>	1	082454
V-belt water pump <i>Keilriemen Wasserpumpe</i>	1	080542
V-belt air conditioner <i>Keilriemen Klimaanlage</i>	1	084264
182562 service package (2000 h) / Service-Paket (2000 h) 643 (TCD 12 Tier 3 / IIIA, HC, WA)		
return flow filter <i>Rücklauffilter</i>	1	150307
leakage oil filter <i>Leckölfilter</i>	1	027376
ventilation filter <i>Belüftungsfilter</i>	1	057228
HydroClean <i>HydroClean</i>	1	150309
engine oil filter <i>Motorölfilter</i>	1	027026
fuel filter <i>Kraftstofffilter</i>	2	084776
filter water separator <i>Filter Wasserabscheider</i>	1	147645
filter heater <i>Filter Heizung</i>	1	107202
filter heater, outside <i>Filter Heizung (außen)</i>	1	107060
air filter safety cartridge <i>Sicherheitspatrone Luftfilter</i>	1	100719
air filter replacement cartridge <i>Austauschpatrone Luftfilter</i>	1	100720
V-belt alternator <i>Keilriemen Lichtmaschine</i>	1	082454
V-belt water pump <i>Keilriemen Wasserpumpe</i>	1	080542
V-belt air conditioner <i>Keilriemen Klimaanlage</i>	1	084264

14.4 SERVICE PACKAGES (2000 H) / SERVICE-PAKETE (2000 H)

Description / Bezeichnung	Qty. / St.	No. / Nr.
187038 service package (2000 h) / Service-Paket (2000 h) 643 (TCD 12 Tier 3 / IIIA, HC, WAH)		
return flow filter Rücklaufilter	1	150307
leakage oil filter Lecköfilter	1	027376
ventilation filter Belüftungsfilter	1	057228
HydroClean HydroClean	1	150309
engine oil filter Motorölfilter	1	027026
fuel filter Kraftstofffilter	2	084776
filter water separator, heatable Filter Wasserabscheider, beheizbar	1	096151
filter heater Filter Heizung	1	107202
filter heater, outside Filter Heizung (außen)	1	107060
air filter safety cartridge Sicherheitspatrone Luftfilter	1	100719
air filter replacement cartridge Austauschpatrone Luftfilter	1	100720
V-belt alternator Keilriemen Lichtmaschine	1	082454
V-belt water pump Keilriemen Wasserpumpe	1	080542
V-belt air conditioner Keilriemen Klimaanlage	1	084264
238550 service package (2000 h) / Service-Paket (2000 h) 643E (QSB 4.5 Tier 3 / IIIA, VF)		
return flow filter Rücklaufilter	1	150307
leakage oil filter Lecköfilter	1	063580
ventilation filter Belüftungsfilter	1	153955
breather filter Entlüftungsfilter	1	168306
auxiliary control filter Vorsteuerfilter	1	150308
engine oil filter Motorölfilter	1	106924
fuel filter Kraftstofffilter	1	103142
filter water separator Filter Wasserabscheider	1	176434
filter air conditioner Filter Klimaanlage	1	138361
air filter safety cartridge Sicherheitspatrone Luftfilter	1	064200
air filter replacement cartridge Austauschpatrone Luftfilter	1	118606
power belt Kraftband	1	116125
238551 service package (2000 h) / Service-Paket (2000 h) 643E (QSB 4.5 Tier 3 / IIIA, HC)		
return flow filter Rücklaufilter	1	150307
leakage oil filter Lecköfilter	1	063580
ventilation filter Belüftungsfilter	1	153955
breather filter Entlüftungsfilter	1	168306
HydroClean HydroClean	1	150309
engine oil filter Motorölfilter	1	106924
fuel filter Kraftstofffilter	1	103142
filter water separator Filter Wasserabscheider	1	176434
filter air conditioner Filter Klimaanlage	1	138361

Description / Bezeichnung	Qty. / St.	No. / Nr.
air filter safety cartridge Sicherheitspatrone Luftfilter	1	064200
air filter replacement cartridge Austauschpatrone Luftfilter	1	118606
power belt Kraftband	1	116125
238559 service package (2000 h) / Service-Paket (2000 h) 643E (QSB 4.5 Tier 4f / IV, VF)		
return flow filter Rücklaufilter	1	150307
leakage oil filter Lecköfilter	1	063580
ventilation filter Belüftungsfilter	1	153955
breather filter Entlüftungsfilter	1	168306
auxiliary control filter Vorsteuerfilter	1	150308
engine oil filter Motorölfilter	1	106924
fuel filter Kraftstofffilter	1	169951
filter water separator Filter Wasserabscheider	1	176434
filter air conditioner Filter Klimaanlage	1	138361
air filter safety cartridge Sicherheitspatrone Luftfilter	1	167974
air filter replacement cartridge Austauschpatrone Luftfilter	1	187692
power belt Kraftband	1	172327
238560 service package (2000 h) / Service-Paket (2000 h) 643E (QSB 4.5 Tier 4f / IV, HC)		
return flow filter Rücklaufilter	1	150307
leakage oil filter Lecköfilter	1	063580
ventilation filter Belüftungsfilter	1	153955
breather filter Entlüftungsfilter	1	168306
HydroClean HydroClean	1	150309
engine oil filter Motorölfilter	1	106924
fuel filter Kraftstofffilter	1	169951
filter water separator Filter Wasserabscheider	1	176434
filter air conditioner Filter Klimaanlage	1	138361
air filter safety cartridge Sicherheitspatrone Luftfilter	1	167974
air filter replacement cartridge Austauschpatrone Luftfilter	1	187692
power belt Kraftband	1	172327
236499 service package (2000 h) / Service-Paket (2000 h) 653E (QSB 4.5 Tier 3 / IIIA, VF)		
return flow filter Rücklaufilter	2	150307
leakage oil filter Lecköfilter	1	027376
ventilation filter Belüftungsfilter	1	153955
breather filter Entlüftungsfilter	1	168306
auxiliary control filter Vorsteuerfilter	1	150308
engine oil filter Motorölfilter	1	106924
fuel filter Kraftstofffilter	1	103142
filter water separator Filter Wasserabscheider	1	176434

Description / Bezeichnung	Qty. / St.	No. / Nr.
filter heater, inside Filter Heizung, innen	1	107202
filter heater, outside Filter Heizung, außen	1	107060
air filter safety cartridge Sicherheitspatrone Luftfilter	1	064200
air filter replacement cartridge Austauschpatrone Luftfilter	1	118606
power belt Kraftband	1	172327
236500 service package (2000 h) / Service-Paket (2000 h) 653E (QSB 4.5 Tier 3 / IIIA, HC)		
return flow filter Rücklaufilter	2	150307
leakage oil filter Lecköfilter	1	027376
ventilation filter Belüftungsfilter	1	153955
breather filter Entlüftungsfilter	1	168306
HydroClean HydroClean	1	150309
engine oil filter Motorölfilter	1	106924
fuel filter Kraftstofffilter	1	103142
filter water separator Filter Wasserabscheider	1	176434
filter heater, inside Filter Heizung, innen	1	107202
filter heater, outside Filter Heizung, außen	1	107060
air filter safety cartridge Sicherheitspatrone Luftfilter	1	064200
air filter replacement cartridge Austauschpatrone Luftfilter	1	118606
power belt Kraftband	1	172327
232250 service package (2000 h) / Service-Paket (2000 h) 653E (QSB 4.5 Tier 4f / IV, VF)		
engine oil filter Motorölfilter	1	106924
fuel filter Kraftstofffilter	1	176434
fuel filter Kraftstofffilter	1	169951
V-belt Keilriemen	1	172327
filter safety cartridge Filter Sicherheitspatrone	1	167974
filter replacement cartridge Filter Austauschpatrone	1	187692
auxiliary control filter Vorsteuerfilter	1	150308
return flow filter Rücklaufilter	2	150307
leakage oil filter Lecköfilter	1	027376
ventilation filter Belüftungsfilter	1	153955
filter heater Filter Heizung	1	107202
filter heater, outside Filter Heizung (außen)	1	107060
breather filter Entlüftungsfilter	1	168306
222346 service package (2000 h) / Service-Paket (2000 h) 653E (QSB 4.5 Tier 4f / IV, HC)		
engine oil filter Motorölfilter	1	106924
fuel filter Kraftstofffilter	1	176434
fuel filter Kraftstofffilter	1	169951
V-belt Keilriemen	1	172327

14.4 SERVICE PACKAGES (2000 H) / SERVICE-PAKETE (2000 H)

Description / Bezeichnung	Qty. / St.	No. / Nr.
filter safety cartridge <i>Filter Sicherheitspatrone</i>	1	167974
filter replacement cartridge <i>Filter Austauschpatrone</i>	1	187692
HydroClean <i>HydroClean</i>	1	150309
return flow filter <i>Rücklauffilter</i>	2	150307
leakage oil filter <i>Leckölfilter</i>	1	027376
ventilation filter <i>Belüftungsfilter</i>	1	153955
filter heater <i>Filter Heizung</i>	1	107202
filter heater, outside <i>Filter Heizung (außen)</i>	1	107060
breather filter <i>Entlüftungsfilter</i>	1	168306
236491 service package (2000 h) / Service-Paket (2000 h) 673E (QSB 6.7 Tier 3 / IIIA, VF)		
return flow filter <i>Rücklauffilter</i>	2	150307
leakage oil filter <i>Leckölfilter</i>	1	027376
ventilation filter <i>Belüftungsfilter</i>	1	153955
auxiliary control filter <i>Vorsteuerfilter</i>	1	150308
engine oil filter <i>Motorölfilter</i>	1	106924
fuel filter <i>Kraftstofffilter</i>	1	103142
filter water separator <i>Filter Wasserabscheider</i>	1	176434
filter heater, inside <i>Filter Heizung, innen</i>	1	107202
filter heater, outside <i>Filter Heizung, außen</i>	1	107060
air filter safety cartridge <i>Sicherheitspatrone Luftfilter</i>	1	167974
air filter replacement cartridge <i>Austauschpatrone Luftfilter</i>	1	167973
V-belt alternator <i>Keilriemen Lichtmaschine</i>	1	189663
V-belt <i>Keilriemen</i>	1	053292
236492 service package (2000 h) / Service-Paket (2000 h) 673E (QSB 6.7 Tier 3 / IIIA, HC)		
return flow filter <i>Rücklauffilter</i>	2	150307
leakage oil filter <i>Leckölfilter</i>	1	027376
ventilation filter <i>Belüftungsfilter</i>	1	153955
HydroClean <i>HydroClean</i>	1	150309
engine oil filter <i>Motorölfilter</i>	1	106924
fuel filter <i>Kraftstofffilter</i>	1	103142
filter water separator <i>Filter Wasserabscheider</i>	1	176434
filter heater, inside <i>Filter Heizung, innen</i>	1	107202
filter heater, outside <i>Filter Heizung, außen</i>	1	107060
air filter safety cartridge <i>Sicherheitspatrone Luftfilter</i>	1	167974
air filter replacement cartridge <i>Austauschpatrone Luftfilter</i>	1	167973
V-belt alternator <i>Keilriemen Lichtmaschine</i>	1	189663
V-belt <i>Keilriemen</i>	1	053292

Description / Bezeichnung	Qty. / St.	No. / Nr.
232253 service package (2000 h) / Service-Paket (2000 h) 673E (QSB 6.7 Tier 4f / IV, VF)		
engine oil filter <i>Motorölfilter</i>	1	106924
fuel filter <i>Kraftstofffilter</i>	1	176434
fuel filter <i>Kraftstofffilter</i>	1	169951
filter crankcase ventilation <i>Filter Kurbelgehäuseentlüftung</i>	1	169482
V-belt <i>Keilriemen</i>	1	169976
V-belt air conditioner <i>Keilriemen Klimaanlage</i>	1	059077
filter safety cartridge <i>Filter Sicherheitspatrone</i>	1	167974
filter replacement cartridge <i>Filter Austauschpatrone</i>	1	167973
auxiliary control filter <i>Vorsteuerfilter</i>	1	150308
return flow filter <i>Rücklauffilter</i>	2	150307
leakage oil filter <i>Leckölfilter</i>	1	027376
ventilation filter <i>Belüftungsfilter</i>	1	174541
filter heater <i>Filter Heizung</i>	1	107202
filter heater, outside <i>Filter Heizung (außen)</i>	1	107060
186444 service package (2000 h) / Service-Paket (2000 h) 673E (QSB 6.7 Tier 4f / IV, HC)		
engine oil filter <i>Motorölfilter</i>	1	106924
filter water separator <i>Filter Wasserabscheider</i>	1	176434
fuel filter <i>Kraftstofffilter</i>	1	169951
filter crankcase ventilation <i>Filter Kurbelgehäuseentlüftung</i>	1	169482
V-belt <i>Keilriemen</i>	1	169976
V-belt air conditioner <i>Keilriemen Klimaanlage</i>	1	059077
filter safety cartridge <i>Filter Sicherheitspatrone</i>	1	167974
filter replacement cartridge <i>Filter Austauschpatrone</i>	1	167973
HydroClean <i>HydroClean</i>	1	150309
return flow filter <i>Rücklauffilter</i>	2	150307
leakage oil filter <i>Leckölfilter</i>	1	027376
ventilation filter <i>Belüftungsfilter</i>	1	174541
filter heater <i>Filter Heizung</i>	1	107202
filter heater, outside <i>Filter Heizung (außen)</i>	1	107060
182563 service package (2000 h) / Service-Paket (2000 h) 683 (TCD 13 Tier 3 / IIIA, VF, WA)		
engine oil filter <i>Motorölfilter</i>	1	027026
fuel filter <i>Kraftstofffilter</i>	2	084776
filter water separator <i>Filter Wasserabscheider</i>	1	147645
auxiliary control filter <i>Vorsteuerfilter</i>	1	150308
V-belt alternator <i>Keilriemen Lichtmaschine</i>	1	082454
V-belt water pump <i>Keilriemen Wasserpumpe</i>	1	030288

Description / Bezeichnung	Qty. / St.	No. / Nr.
V-belt air conditioner <i>Keilriemen Klimaanlage</i>	1	059077
air filter safety cartridge <i>Sicherheitspatrone Luftfilter</i>	1	064200
air filter replacement cartridge <i>Austauschpatrone Luftfilter</i>	1	118606
return flow filter <i>Rücklauffilter</i>	2	150307
leakage oil filter <i>Leckölfilter</i>	1	027376
ventilation filter <i>Belüftungsfilter</i>	1	057228
filter heater <i>Filter Heizung</i>	1	107202
filter heater, outside <i>Filter Heizung (außen)</i>	1	107060
187041 service package (2000 h) / Service-Paket (2000 h) 683 (TCD 13 Tier 3 / IIIA, VF, WAH)		
engine oil filter <i>Motorölfilter</i>	1	027026
fuel filter <i>Kraftstofffilter</i>	2	084776
filter water separator, heatable <i>Filter Wasserabscheider, beheizbar</i>	1	096151
auxiliary control filter <i>Vorsteuerfilter</i>	1	150308
V-belt alternator <i>Keilriemen Lichtmaschine</i>	1	082454
V-belt water pump <i>Keilriemen Wasserpumpe</i>	1	030288
V-belt air conditioner <i>Keilriemen Klimaanlage</i>	1	059077
air filter safety cartridge <i>Sicherheitspatrone Luftfilter</i>	1	064200
air filter replacement cartridge <i>Austauschpatrone Luftfilter</i>	1	118606
return flow filter <i>Rücklauffilter</i>	2	150307
leakage oil filter <i>Leckölfilter</i>	1	027376
ventilation filter <i>Belüftungsfilter</i>	1	057228
filter heater <i>Filter Heizung</i>	1	107202
filter heater, outside <i>Filter Heizung (außen)</i>	1	107060
182564 service package (2000 h) / Service-Paket (2000 h) 683 (TCD 13 Tier 3 / IIIA, HC, WA)		
engine oil filter <i>Motorölfilter</i>	1	027026
fuel filter <i>Kraftstofffilter</i>	2	084776
filter water separator <i>Filter Wasserabscheider</i>	1	147645
HydroClean <i>HydroClean</i>	1	150309
V-belt alternator <i>Keilriemen Lichtmaschine</i>	1	082454
V-belt water pump <i>Keilriemen Wasserpumpe</i>	1	030288
V-belt air conditioner <i>Keilriemen Klimaanlage</i>	1	059077
air filter safety cartridge <i>Sicherheitspatrone Luftfilter</i>	1	064200
air filter replacement cartridge <i>Austauschpatrone Luftfilter</i>	1	118606
return flow filter <i>Rücklauffilter</i>	2	150307
leakage oil filter <i>Leckölfilter</i>	1	027376
ventilation filter <i>Belüftungsfilter</i>	1	057228
filter heater <i>Filter Heizung</i>	1	107202
filter heater, outside <i>Filter Heizung (außen)</i>	1	107060

14.4 SERVICE PACKAGES (2000 H) / SERVICE-PAKETE (2000 H)

Description / Bezeichnung	Qty. / St.	No. / Nr.
187042 service package (2000 h) / Service-Paket (2000 h) 683 (TCD 13 Tier 3 / IIIA, HC, WAH)		
engine oil filter <i>Motorölfilter</i>	1	027026
fuel filter <i>Kraftstofffilter</i>	2	084776
filter water separator, heatable <i>Filter Wasserabscheider, beheizbar</i>	1	096151
HydroClean <i>HydroClean</i>	1	150309
V-belt alternator <i>Keilriemen Lichtmaschine</i>	1	082454
V-belt water pump <i>Keilriemen Wasserpumpe</i>	1	030288
V-belt air conditioner <i>Keilriemen Klimaanlage</i>	1	059077
air filter safety cartridge <i>Sicherheitspatrone Luftfilter</i>	1	064200
air filter replacement cartridge <i>Austauschpatrone Luftfilter</i>	1	118606
return flow filter <i>Rücklaufilter</i>	2	150307
leakage oil filter <i>Leckölfilter</i>	1	027376
ventilation filter <i>Belüftungsfilter</i>	1	057228
filter heater <i>Filter Heizung</i>	1	107202
filter heater, outside <i>Filter Heizung (außen)</i>	1	107060
242399 service package (2000 h) / Service-Paket (2000 h) 6113E (QSB 6.7 Tier 3 / IIIA, VF)		
return flow filter <i>Rücklaufilter</i>	2	150307
leakage oil filter <i>Leckölfilter</i>	1	027376
ventilation filter <i>Belüftungsfilter</i>	1	153955
breather filter <i>Entlüftungsfilter</i>	1	168306
auxiliary control filter <i>Vorsteuerfilter</i>	1	150308
engine oil filter <i>Motorölfilter</i>	1	106924
fuel filter <i>Kraftstofffilter</i>	1	103142
filter water separator <i>Filter Wasserabscheider</i>	1	176434
filter crankcase ventilation <i>Filter Kurbelgehäuseentlüftung</i>	1	169482
filter heater, inside <i>Filter Heizung, innen</i>	1	107202
filter heater, outside <i>Filter Heizung, außen</i>	1	107060
air filter safety cartridge <i>Sicherheitspatrone Luftfilter</i>	1	167974
air filter replacement cartridge <i>Austauschpatrone Luftfilter</i>	1	167973
V-belt alternator <i>Keilriemen Lichtmaschine</i>	1	189663
V-belt <i>Keilriemen</i>	1	053292
242400 service package (2000 h) / Service-Paket (2000 h) 6113E (QSB 6.7 Tier 3 / IIIA, HC)		
return flow filter <i>Rücklaufilter</i>	2	150307
leakage oil filter <i>Leckölfilter</i>	1	027376
ventilation filter <i>Belüftungsfilter</i>	1	153955
breather filter <i>Entlüftungsfilter</i>	1	168306
HydroClean <i>HydroClean</i>	1	150309
engine oil filter <i>Motorölfilter</i>	1	106924
fuel filter <i>Kraftstofffilter</i>	1	169951
filter water separator <i>Filter Wasserabscheider</i>	1	176434
filter crankcase ventilation <i>Filter Kurbelgehäuseentlüftung</i>	1	169482
filter heater, inside <i>Filter Heizung, innen</i>	1	107202
filter heater, outside <i>Filter Heizung, außen</i>	1	107060
air filter safety cartridge <i>Sicherheitspatrone Luftfilter</i>	1	167974

Description / Bezeichnung	Qty. / St.	No. / Nr.
fuel filter <i>Kraftstofffilter</i>	1	103142
filter water separator <i>Filter Wasserabscheider</i>	1	176434
filter crankcase ventilation <i>Filter Kurbelgehäuseentlüftung</i>	1	169482
filter heater, inside <i>Filter Heizung, innen</i>	1	107202
filter heater, outside <i>Filter Heizung, außen</i>	1	107060
air filter safety cartridge <i>Sicherheitspatrone Luftfilter</i>	1	167974
air filter replacement cartridge <i>Austauschpatrone Luftfilter</i>	1	167973
V-belt alternator <i>Keilriemen Lichtmaschine</i>	1	189663
V-belt <i>Keilriemen</i>	1	053292
242509 service package (2000 h) / Service-Paket (2000 h) 6113E (QSB 6.7 Tier 4f / IV, VF)		
return flow filter <i>Rücklaufilter</i>	2	150307
leakage oil filter <i>Leckölfilter</i>	1	027376
ventilation filter <i>Belüftungsfilter</i>	1	153955
breather filter <i>Entlüftungsfilter</i>	1	168306
auxiliary control filter <i>Vorsteuerfilter</i>	1	150308
engine oil filter <i>Motorölfilter</i>	1	106924
fuel filter <i>Kraftstofffilter</i>	1	169951
filter water separator <i>Filter Wasserabscheider</i>	1	176434
filter crankcase ventilation <i>Filter Kurbelgehäuseentlüftung</i>	1	169482
filter heater, inside <i>Filter Heizung, innen</i>	1	107202
filter heater, outside <i>Filter Heizung, außen</i>	1	107060
air filter safety cartridge <i>Sicherheitspatrone Luftfilter</i>	1	167974
air filter replacement cartridge <i>Austauschpatrone Luftfilter</i>	1	167973
V-belt <i>Keilriemen</i>	1	167976
V-belt <i>Keilriemen</i>	1	161492
242510 service package (2000 h) / Service-Paket (2000 h) 6113E (QSB 6.7 Tier 4f / IV, HC)		
return flow filter <i>Rücklaufilter</i>	2	150307
leakage oil filter <i>Leckölfilter</i>	1	027376
ventilation filter <i>Belüftungsfilter</i>	1	153955
breather filter <i>Entlüftungsfilter</i>	1	168306
HydroClean <i>HydroClean</i>	1	150309
engine oil filter <i>Motorölfilter</i>	1	106924
fuel filter <i>Kraftstofffilter</i>	1	169951
filter water separator <i>Filter Wasserabscheider</i>	1	176434
filter crankcase ventilation <i>Filter Kurbelgehäuseentlüftung</i>	1	169482
filter heater, inside <i>Filter Heizung, innen</i>	1	107202
filter heater, outside <i>Filter Heizung, außen</i>	1	107060
air filter safety cartridge <i>Sicherheitspatrone Luftfilter</i>	1	167974

Description / Bezeichnung	Qty. / St.	No. / Nr.
air filter replacement cartridge <i>Austauschpatrone Luftfilter</i>	1	167973
V-belt <i>Keilriemen</i>	1	167976
V-belt <i>Keilriemen</i>	1	161492
182559 service package (2000 h) / Service-Paket (2000 h) 630D (TCD 13 Tier 3 / IIIA, VF)		
return flow filter <i>Rücklaufilter</i>	2	150307
leakage oil filter <i>Leckölfilter</i>	1	027376
ventilation filter <i>Belüftungsfilter</i>	1	057228
auxiliary control filter <i>Vorsteuerfilter</i>	2	150308
pressure filter <i>Druckfilter</i>	1	205125
engine oil filter <i>Motorölfilter</i>	1	027026
fuel filter <i>Kraftstofffilter</i>	2	084776
filter water separator <i>Filter Wasserabscheider</i>	1	147645
filter heater <i>Filter Heizung</i>	1	107202
filter heater, outside <i>Filter Heizung (außen)</i>	1	107060
air filter safety cartridge <i>Sicherheitspatrone Luftfilter</i>	1	064200
air filter replacement cartridge <i>Austauschpatrone Luftfilter</i>	1	118606
V-belt alternator <i>Keilriemen Lichtmaschine</i>	1	082454
V-belt water pump <i>Keilriemen Wasserpumpe</i>	1	109242
V-belt air conditioner <i>Keilriemen Klimaanlage</i>	1	059077
182560 service package (2000 h) / Service-Paket (2000 h) 630D (TCD 13 Tier 3 / IIIA, HC)		
return flow filter <i>Rücklaufilter</i>	2	150307
leakage oil filter <i>Leckölfilter</i>	1	027376
ventilation filter <i>Belüftungsfilter</i>	1	057228
HydroClean <i>HydroClean</i>	1	150309
auxiliary control filter <i>Vorsteuerfilter</i>	1	150308
pressure filter <i>Druckfilter</i>	1	205125
engine oil filter <i>Motorölfilter</i>	1	027026
fuel filter <i>Kraftstofffilter</i>	2	084776
filter water separator <i>Filter Wasserabscheider</i>	1	147645
filter heater <i>Filter Heizung</i>	1	107202
filter heater, outside <i>Filter Heizung (außen)</i>	1	107060
air filter safety cartridge <i>Sicherheitspatrone Luftfilter</i>	1	064200
air filter replacement cartridge <i>Austauschpatrone Luftfilter</i>	1	118606
V-belt alternator <i>Keilriemen Lichtmaschine</i>	1	082454
V-belt water pump <i>Keilriemen Wasserpumpe</i>	1	109242
V-belt air conditioner <i>Keilriemen Klimaanlage</i>	1	059077

14.4 SERVICE PACKAGES (2000 H) / SERVICE-PAKETE (2000 H)

Description / Bezeichnung	Qty. / St.	No. / Nr.
217281 service package (2000 h) / Service-Paket (2000 h) 640E (CAT C7.1 Tier 3 / IIIA)		
engine oil filter <i>Motorölfilter</i>	1	177580
fuel filter <i>Kraftstofffilter</i>	2	177606
filter water separator <i>Filter Wasserabscheider</i>	1	064893
air filter safety cartridge <i>Sicherheitspatrone Luftfilter</i>	1	149255
air filter replacement cartridge <i>Austauschpatrone Luftfilter</i>	1	149256
filter heater <i>Filter Heizung</i>	1	107202
filter heater, outside <i>Filter Heizung (außen)</i>	1	107060
return flow filter <i>Rücklauffilter</i>	1	151945
leakage oil filter <i>Leckölfilter</i>	2	027376
ventilation filter <i>Belüftungsfilter</i>	1	153955
HydroClean <i>HydroClean</i>	1	150309
auxiliary control filter <i>Vorsteuerfilter</i>	2	150308
V-belt air conditioner <i>Keilriemen Klimaanlage</i>	2	154947
217285 service package (2000 h) / Service-Paket (2000 h) 640E (CAT C7.1 Tier 4f / IV)		
engine oil filter <i>Motorölfilter</i>	1	177580
fuel filter <i>Kraftstofffilter</i>	2	177606
filter water separator <i>Filter Wasserabscheider</i>	1	171162
air filter safety cartridge <i>Sicherheitspatrone Luftfilter</i>	1	149255
air filter replacement cartridge <i>Austauschpatrone Luftfilter</i>	1	149256
filter heater <i>Filter Heizung</i>	1	107202
filter heater, outside <i>Filter Heizung (außen)</i>	1	107060
return flow filter <i>Rücklauffilter</i>	1	151945
leakage oil filter <i>Leckölfilter</i>	2	027376
ventilation filter <i>Belüftungsfilter</i>	1	153955
HydroClean <i>HydroClean</i>	1	150309
auxiliary control filter <i>Vorsteuerfilter</i>	2	150308
V-belt air conditioner <i>Keilriemen Klimaanlage</i>	2	154947
236460 service package (2000 h) / Service-Paket (2000 h) 1100E (QSB 6.7 Tier 4f / IV, VF)		
engine oil filter <i>Motorölfilter</i>	1	106924
fuel filter <i>Kraftstofffilter</i>	1	169951
filter water separator <i>Filter Wasserabscheider</i>	1	176434
V-belt <i>Keilriemen</i>	1	167976
V-belt <i>Keilriemen</i>	1	161492
air filter safety cartridge <i>Sicherheitspatrone Luftfilter</i>	1	167974
air filter replacement cartridge <i>Austauschpatrone Luftfilter</i>	1	167973
auxiliary control filter <i>Vorsteuerfilter</i>	1	150308

Description / Bezeichnung	Qty. / St.	No. / Nr.
return flow filter <i>Rücklauffilter</i>	1	151945
leakage oil filter <i>Leckölfilter</i>	1	027376
breather filter <i>Entlüftungsfilter</i>	1	168306
ventilation filter <i>Belüftungsfilter</i>	1	153955
filter heater, inside <i>Filter Heizung, innen</i>	1	107202
filter heater, outside <i>Filter Heizung, außen</i>	1	107060
236559 service package (2000 h) / Service-Paket (2000 h) 1100E (QSB 6.7 Tier 4f / IV, HC)		
engine oil filter <i>Motorölfilter</i>	1	106924
fuel filter <i>Kraftstofffilter</i>	1	169951
filter water separator <i>Filter Wasserabscheider</i>	1	176434
V-belt <i>Keilriemen</i>	1	167976
V-belt <i>Keilriemen</i>	1	161492
air filter safety cartridge <i>Sicherheitspatrone Luftfilter</i>	1	167974
air filter replacement cartridge <i>Austauschpatrone Luftfilter</i>	1	167973
HydroClean <i>HydroClean</i>	1	150309
return flow filter <i>Rücklauffilter</i>	1	151945
leakage oil filter <i>Leckölfilter</i>	1	027376
breather filter <i>Entlüftungsfilter</i>	1	168306
ventilation filter <i>Belüftungsfilter</i>	1	153955
filter heater, inside <i>Filter Heizung, innen</i>	1	107202
filter heater, outside <i>Filter Heizung, außen</i>	1	107060
182567 service package (2000 h) / Service-Paket (2000 h) 2200 (Cat C7 Tier 3 / IIIA, VF)		
return flow filter <i>Rücklauffilter</i>	4	150307
leakage oil filter <i>Leckölfilter</i>	2	027376
ventilation filter <i>Belüftungsfilter</i>	1	057228
auxiliary control filter <i>Vorsteuerfilter</i>	1	150308
engine oil filter <i>Motorölfilter</i>	1	080749
fuel filter <i>Kraftstofffilter</i>	1	043277
filter water separator <i>Filter Wasserabscheider</i>	1	083176
filter heater <i>Filter Heizung</i>	1	107202
filter heater, outside <i>Filter Heizung (außen)</i>	1	107060
air filter safety cartridge <i>Sicherheitspatrone Luftfilter</i>	1	064200
air filter replacement cartridge <i>Austauschpatrone Luftfilter</i>	1	118606
V-belt alternator <i>Keilriemen Lichtmaschine</i>	1	072533
V-belt water pump <i>Keilriemen Wasserpumpe</i>	1	099128
V-belt air conditioner <i>Keilriemen Klimaanlage</i>	1	084264

Description / Bezeichnung	Qty. / St.	No. / Nr.
182568 service package (2000 h) / Service-Paket (2000 h) 2200 (Cat C7 Tier 3 / IIIA, HC)		
return flow filter <i>Rücklauffilter</i>	4	150307
leakage oil filter <i>Leckölfilter</i>	2	027376
ventilation filter <i>Belüftungsfilter</i>	1	057228
HydroClean <i>HydroClean</i>	1	150309
engine oil filter <i>Motorölfilter</i>	1	080749
fuel filter <i>Kraftstofffilter</i>	1	043277
filter water separator <i>Filter Wasserabscheider</i>	1	083176
filter heater <i>Filter Heizung</i>	1	107202
filter heater, outside <i>Filter Heizung (außen)</i>	1	107060
air filter safety cartridge <i>Sicherheitspatrone Luftfilter</i>	1	064200
air filter replacement cartridge <i>Austauschpatrone Luftfilter</i>	1	118606
V-belt alternator <i>Keilriemen Lichtmaschine</i>	1	072533
V-belt water pump <i>Keilriemen Wasserpumpe</i>	1	099128
V-belt air conditioner <i>Keilriemen Klimaanlage</i>	1	084264
182565 service package (2000 h) / Service-Paket (2000 h) 2200E (Cat C7 Tier 3 / IIIA, VF)		
engine oil filter <i>Motorölfilter</i>	1	080749
fuel filter <i>Kraftstofffilter</i>	1	043277
filter water separator <i>Filter Wasserabscheider</i>	1	083176
auxiliary control filter <i>Vorsteuerfilter</i>	1	150308
V-belt water pump <i>Keilriemen Wasserpumpe</i>	1	099128
V-belt alternator <i>Keilriemen Lichtmaschine</i>	1	072533
V-belt air conditioner <i>Keilriemen Klimaanlage</i>	1	084264
air filter safety cartridge <i>Sicherheitspatrone Luftfilter</i>	1	149255
air filter replacement cartridge <i>Austauschpatrone Luftfilter</i>	1	149256
return flow filter <i>Rücklauffilter</i>	1	151945
leakage oil filter <i>Leckölfilter</i>	2	027376
ventilation filter <i>Belüftungsfilter</i>	1	174541
filter heater <i>Filter Heizung</i>	1	107202
filter heater, outside <i>Filter Heizung (außen)</i>	1	107060

14.4 SERVICE PACKAGES (2000 H) / SERVICE-PAKETE (2000 H)

Description / Bezeichnung	Qty. / St.	No. / Nr.
182566 service package (2000 h) / Service-Paket (2000 h) 2200E (Cat C7 Tier 3 / IIIA, HC)		
engine oil filter <i>Motorölfilter</i>	1	080749
fuel filter <i>Kraftstofffilter</i>	1	043277
filter water separator <i>Filter Wasserabscheider</i>	1	083176
HydroClean <i>HydroClean</i>	1	150309
V-belt water pump <i>Keilriemen Wasserpumpe</i>	1	099128
V-belt alternator <i>Keilriemen Lichtmaschine</i>	1	072533
V-belt air conditioner <i>Keilriemen Klimaanlage</i>	1	084264
air filter safety cartridge <i>Sicherheitspatrone Luftfilter</i>	1	149255
air filter replacement cartridge <i>Austauschpatrone Luftfilter</i>	1	149256
return flow filter <i>Rücklauffilter</i>	1	151945
leakage oil filter <i>Leckölfilter</i>	2	027376
ventilation filter <i>Belüftungsfilter</i>	1	174541
filter heater <i>Filter Heizung</i>	1	107202
filter heater, outside <i>Filter Heizung (außen)</i>	1	107060
244267 service package (2000 h) / Service-Paket (2000 h) 2200E (CAT C7.1 Tier 4f / IV, VF)		
return flow filter <i>Rücklauffilter</i>	1	151945
leakage oil filter <i>Leckölfilter</i>	2	027376
ventilation filter <i>Belüftungsfilter</i>	1	174541
breather filter <i>Entlüftungsfilter</i>	1	168306
auxiliary control filter <i>Vorsteuerfilter</i>	1	150308
engine oil filter <i>Motorölfilter</i>	1	177580
fuel filter <i>Kraftstofffilter</i>	2	219995
filter water separator <i>Filter Wasserabscheider</i>	1	171162
filter heater, inside <i>Filter Heizung, innen</i>	1	107202
filter heater, outside <i>Filter Heizung, außen</i>	1	107060
air filter safety cartridge <i>Sicherheitspatrone Luftfilter</i>	1	149255
air filter replacement cartridge <i>Austauschpatrone Luftfilter</i>	1	149256
V-belt fan drive <i>Keilriemen Lüfterantrieb</i>	1	198272
244268 service package (2000 h) / Service-Paket (2000 h) 2200E (CAT C7.1 Tier 4f / IV, HC)		
return flow filter <i>Rücklauffilter</i>	1	151945
leakage oil filter <i>Leckölfilter</i>	2	027376
ventilation filter <i>Belüftungsfilter</i>	1	174541
breather filter <i>Entlüftungsfilter</i>	1	168306

Description / Bezeichnung	Qty. / St.	No. / Nr.
HydroClean <i>HydroClean</i>	1	150309
engine oil filter <i>Motorölfilter</i>	1	177580
fuel filter <i>Kraftstofffilter</i>	2	219995
filter water separator <i>Filter Wasserabscheider</i>	1	171162
filter heater, inside <i>Filter Heizung, innen</i>	1	107202
filter heater, outside <i>Filter Heizung, außen</i>	1	107060
air filter safety cartridge <i>Sicherheitspatrone Luftfilter</i>	1	149255
air filter replacement cartridge <i>Austauschpatrone Luftfilter</i>	1	149256
V-belt fan drive <i>Keilriemen Lüfterantrieb</i>	1	198272
182569 service package (2000 h) / Service-Paket (2000 h) 3300 (Cat C7 Tier 3 / IIIA, VF)		
return flow filter <i>Rücklauffilter</i>	3	150307
leakage oil filter <i>Leckölfilter</i>	2	027376
ventilation filter <i>Belüftungsfilter</i>	1	057228
auxiliary control filter <i>Vorsteuerfilter</i>	1	150308
engine oil filter <i>Motorölfilter</i>	1	080749
fuel filter <i>Kraftstofffilter</i>	1	043277
filter water separator <i>Filter Wasserabscheider</i>	1	083176
filter heater <i>Filter Heizung</i>	1	107202
filter heater, outside <i>Filter Heizung (außen)</i>	1	107060
air filter safety cartridge <i>Sicherheitspatrone Luftfilter</i>	1	064200
air filter replacement cartridge <i>Austauschpatrone Luftfilter</i>	1	118606
V-belt alternator <i>Keilriemen Lichtmaschine</i>	1	072533
V-belt water pump <i>Keilriemen Wasserpumpe</i>	1	099128
V-belt air conditioner <i>Keilriemen Klimaanlage</i>	1	084264
182570 service package (2000 h) / Service-Paket (2000 h) 3300 (Cat C7 Tier 3 / IIIA, HC)		
return flow filter <i>Rücklauffilter</i>	3	150307
leakage oil filter <i>Leckölfilter</i>	2	027376
ventilation filter <i>Belüftungsfilter</i>	1	057228
HydroClean <i>HydroClean</i>	1	150309
engine oil filter <i>Motorölfilter</i>	1	080749
fuel filter <i>Kraftstofffilter</i>	1	043277
filter water separator <i>Filter Wasserabscheider</i>	1	083176
filter heater <i>Filter Heizung</i>	1	107202
filter heater, outside <i>Filter Heizung (außen)</i>	1	107060

Description / Bezeichnung	Qty. / St.	No. / Nr.
air filter safety cartridge <i>Sicherheitspatrone Luftfilter</i>	1	064200
air filter replacement cartridge <i>Austauschpatrone Luftfilter</i>	1	118606
V-belt alternator <i>Keilriemen Lichtmaschine</i>	1	072533
V-belt water pump <i>Keilriemen Wasserpumpe</i>	1	099128
V-belt air conditioner <i>Keilriemen Klimaanlage</i>	1	084264
182571 service package (2000 h) / Service-Paket (2000 h) 5500 (Cat C9 Tier 3 / IIIA, VF)		
return flow filter <i>Rücklauffilter</i>	3	150307
leakage oil filter <i>Leckölfilter</i>	2	027376
ventilation filter <i>Belüftungsfilter</i>	1	057228
auxiliary control filter <i>Vorsteuerfilter</i>	1	150308
engine oil filter <i>Motorölfilter</i>	1	085693
fuel filter <i>Kraftstofffilter</i>	1	043277
filter water separator <i>Filter Wasserabscheider</i>	1	083176
filter heater <i>Filter Heizung</i>	1	107202
filter heater, outside <i>Filter Heizung (außen)</i>	1	107060
air filter safety cartridge <i>Sicherheitspatrone Luftfilter</i>	1	068827
air filter replacement cartridge <i>Austauschpatrone Luftfilter</i>	1	068826
V-belt alternator <i>Keilriemen Lichtmaschine</i>	1	093632
V-belt water pump <i>Keilriemen Wasserpumpe</i>	1	093633
V-belt air conditioner <i>Keilriemen Klimaanlage</i>	1	084264
182572 service package (2000 h) / Service-Paket (2000 h) 5500 (Cat C9 Tier 3 / IIIA, HC)		
return flow filter <i>Rücklauffilter</i>	3	150307
leakage oil filter <i>Leckölfilter</i>	2	027376
ventilation filter <i>Belüftungsfilter</i>	1	057228
HydroClean <i>HydroClean</i>	1	150309
engine oil filter <i>Motorölfilter</i>	1	085693
fuel filter <i>Kraftstofffilter</i>	1	043277
filter water separator <i>Filter Wasserabscheider</i>	1	083176
filter heater <i>Filter Heizung</i>	1	107202
filter heater, outside <i>Filter Heizung (außen)</i>	1	107060
air filter safety cartridge <i>Sicherheitspatrone Luftfilter</i>	1	068827
air filter replacement cartridge <i>Austauschpatrone Luftfilter</i>	1	068826
V-belt alternator <i>Keilriemen Lichtmaschine</i>	1	093632
V-belt water pump <i>Keilriemen Wasserpumpe</i>	1	093633
V-belt air conditioner <i>Keilriemen Klimaanlage</i>	1	084264

14.4 SERVICE PACKAGES (2000 H) / SERVICE-PAKETE (2000 H)

Description / Bezeichnung	Qty. / St.	No. / Nr.
232397 service package (2000 h) / Service-Paket (2000 h) 5500E (CAT C9 Tier 3 / IIIA, VF)		
auxiliary control filter <i>Vorsteuerfilter</i>	1	150308
return flow filter <i>Rücklauffilter</i>	1	151945
leakage oil filter <i>Leckölfilter</i>	2	027376
ventilation filter <i>Belüftungsfilter</i>	1	153955
breather filter <i>Entlüftungsfilter</i>	1	168306
engine oil filter <i>Motorölfilter</i>	1	085693
fuel filter <i>Kraftstofffilter</i>	1	043277
filter water separator <i>Filter Wasserabscheider</i>	1	083176
air filter safety cartridge <i>Sicherheitspatrone Luftfilter</i>	1	146689
air filter replacement cartridge <i>Austauschpatrone Luftfilter</i>	1	146690
filter heater, inside <i>Filter Heizung, innen</i>	1	107202
filter heater, outside <i>Filter Heizung, außen</i>	1	107060
V-belt set (2 pcs.) <i>Keilriemensatz(2 Stk.)</i>	1	227767
V-belt water pump <i>Keilriemen Wasserpumpe</i>	1	093633
V-belt <i>Keilriemen</i>	1	059076
232398 service package (2000 h) / Service-Paket (2000 h) 5500E (CAT C9 Tier 3 / IIIA, HC)		
HydroClean <i>HydroClean</i>	1	150309
return flow filter <i>Rücklauffilter</i>	1	151945
leakage oil filter <i>Leckölfilter</i>	2	027376
ventilation filter <i>Belüftungsfilter</i>	1	153955
breather filter <i>Entlüftungsfilter</i>	1	168306
engine oil filter <i>Motorölfilter</i>	1	085693
fuel filter <i>Kraftstofffilter</i>	1	043277
filter water separator <i>Filter Wasserabscheider</i>	1	083176
air filter safety cartridge <i>Sicherheitspatrone Luftfilter</i>	1	146689
air filter replacement cartridge <i>Austauschpatrone Luftfilter</i>	1	146690
filter heater, inside <i>Filter Heizung, innen</i>	1	107202
filter heater, outside <i>Filter Heizung, außen</i>	1	107060
V-belt set (2 pcs.) <i>Keilriemensatz(2 Stk.)</i>	1	227767
V-belt water pump <i>Keilriemen Wasserpumpe</i>	1	093633
V-belt <i>Keilriemen</i>	1	059076

Description / Bezeichnung	Qty. / St.	No. / Nr.
231675 service package (2000 h) / Service-Paket (2000 h) 5500E (CAT C9.3 Tier 4f / IV, VF)		
engine oil filter <i>Motorölfilter</i>	1	085693
fuel filter <i>Kraftstofffilter</i>	2	040247
filter water separator <i>Filter Wasserabscheider</i>	1	083176
V-belt <i>Keilriemen</i>	1	205689
V-belt <i>Keilriemen</i>	1	170300
air filter safety cartridge <i>Sicherheitspatrone Luftfilter</i>	1	149255
air filter replacement cartridge <i>Austauschpatrone Luftfilter</i>	1	149256
auxiliary control filter <i>Vorsteuerfilter</i>	1	150308
return flow filter <i>Rücklauffilter</i>	1	151945
leakage oil filter <i>Leckölfilter</i>	2	027376
breather filter <i>Entlüftungsfilter</i>	1	168306
ventilation filter <i>Belüftungsfilter</i>	1	153955
filter heater <i>Filter Heizung</i>	1	107202
filter heater, outside <i>Filter Heizung (außen)</i>	1	107060
231676 service package (2000 h) / Service-Paket (2000 h) 5500E (CAT C9.3 Tier 4f / IV, HC)		
engine oil filter <i>Motorölfilter</i>	1	085693
fuel filter <i>Kraftstofffilter</i>	2	040247
filter water separator <i>Filter Wasserabscheider</i>	1	083176
V-belt <i>Keilriemen</i>	1	205689
V-belt <i>Keilriemen</i>	1	170300
air filter safety cartridge <i>Sicherheitspatrone Luftfilter</i>	1	149255
air filter replacement cartridge <i>Austauschpatrone Luftfilter</i>	1	149256
HydroClean <i>HydroClean</i>	1	150309
return flow filter <i>Rücklauffilter</i>	1	151945
leakage oil filter <i>Leckölfilter</i>	2	027376
breather filter <i>Entlüftungsfilter</i>	1	168306
ventilation filter <i>Belüftungsfilter</i>	1	153955
filter heater <i>Filter Heizung</i>	1	107202
filter heater, outside <i>Filter Heizung (außen)</i>	1	107060

Description / Bezeichnung	Qty. / St.	No. / Nr.
182573 service package (2000 h) / Service-Paket (2000 h) 7700 (Cat C11 Tier 3 / IIIA, VF)		
return flow filter <i>Rücklauffilter</i>	3	150307
leakage oil filter <i>Leckölfilter</i>	2	027376
ventilation filter <i>Belüftungsfilter</i>	1	057228
auxiliary control filter <i>Vorsteuerfilter</i>	1	150308
engine oil filter <i>Motorölfilter</i>	1	085693
fuel filter <i>Kraftstofffilter</i>	1	105680
filter water separator <i>Filter Wasserabscheider</i>	1	083176
filter heater <i>Filter Heizung</i>	1	107202
filter heater, outside <i>Filter Heizung (außen)</i>	1	107060
air filter safety cartridge <i>Sicherheitspatrone Luftfilter</i>	1	068827
air filter replacement cartridge <i>Austauschpatrone Luftfilter</i>	1	068826
V-belt alternator <i>Keilriemen Lichtmaschine</i>	1	076929
V-belt air conditioner <i>Keilriemen Klimaanlage</i>	1	105682
182574 service package (2000 h) / Service-Paket (2000 h) 7700 (Cat C11 Tier 3 / IIIA, HC)		
return flow filter <i>Rücklauffilter</i>	3	150307
leakage oil filter <i>Leckölfilter</i>	2	027376
ventilation filter <i>Belüftungsfilter</i>	1	057228
HydroClean <i>HydroClean</i>	1	150309
engine oil filter <i>Motorölfilter</i>	1	085693
fuel filter <i>Kraftstofffilter</i>	1	105680
filter water separator <i>Filter Wasserabscheider</i>	1	083176
filter heater <i>Filter Heizung</i>	1	107202
filter heater, outside <i>Filter Heizung (außen)</i>	1	107060
air filter safety cartridge <i>Sicherheitspatrone Luftfilter</i>	1	068827
air filter replacement cartridge <i>Austauschpatrone Luftfilter</i>	1	068826
V-belt alternator <i>Keilriemen Lichtmaschine</i>	1	076929
V-belt air conditioner <i>Keilriemen Klimaanlage</i>	1	105682

14.5 INSPECTION SETS (2000 H)

INSPEKTIONSSÄTZE (2000 H)

Description / Bezeichnung	Qty. / St.	No. / Nr.
245663 inspection set (2000 h) / Inspektionssatz (2000 h) 355E (FPT N45 Tier 4f, VF)		
return flow filter Rücklauffilter	2	228568
leakage oil filter Leckölfilter	2	063580
ventilation filter Belüftungsfilter	2	236336
auxiliary control filter Vorsteuerfilter	2	228567
breather filter Entlüftungsfilter	2	168306
engine oil filter Motorölfilter	2	206076
fuel filter Kraftstofffilter	2	103142
filter water separator Filter Wasserabscheider	2	176434
filter air conditioner Filter Klimaanlage	2	138361
air filter safety cartridge Sicherheitspatrone Luftfilter	2	149255
air filter replacement cartridge Austauschpatrone Luftfilter	2	149256
V-belt Keilriemen	2	206172
V-belt air conditioner Keilriemen Klimaanlage	2	239043
227812 inspection set (2000 h) / Inspektionssatz (2000 h) 718E (QSB 4.5 Tier 4f / IV, VF)		
leakage oil filter Leckölfilter	2	027376
engine oil filter Motorölfilter	4	106924
filter heater, outside Filter Heizung (außen)	2	107060
filter heater Filter Heizung	2	107202
auxiliary control filter Vorsteuerfilter	2	150308
return flow filter Rücklauffilter	2	151945
ventilation filter Belüftungsfilter	2	153955
line filter Speisedruckfilter	2	154947
filter safety cartridge Filter Sicherheitspatrone	2	167974
fuel filter Kraftstofffilter	4	169951
filter crankcase ventilation Filter Kurbelgehäuseentlüftung	1	169954
V-belt Keilriemen	2	172327
filter water separator Filter Wasserabscheider	4	176434
filter replacement cartridge Filter Austauschpatrone	2	187692
224404 inspection set (2000 h) / Inspektionssatz (2000 h) 718E (QSB 4.5 Tier 4f / IV, HC)		
leakage oil filter Leckölfilter	2	027376
engine oil filter Motorölfilter	4	106924
filter heater, outside Filter Heizung (außen)	2	107060
filter heater Filter Heizung	2	107202
HydroClean HydroClean	2	150309
return flow filter Rücklauffilter	2	151945

Description / Bezeichnung	Qty. / St.	No. / Nr.
ventilation filter Belüftungsfilter	2	153955
line filter Speisedruckfilter	2	154947
filter safety cartridge Filter Sicherheitspatrone	2	167974
fuel filter Kraftstofffilter	4	169951
filter crankcase ventilation Filter Kurbelgehäuseentlüftung	1	169954
V-belt Keilriemen	2	172327
filter water separator Filter Wasserabscheider	4	176434
filter replacement cartridge Filter Austauschpatrone	2	187692
231016 inspection set (2000 h) / Inspektionssatz (2000 h) 723E (QSB 4.5 Tier 4f / IV, VF)		
engine oil filter Motorölfilter	4	106924
fuel filter Kraftstofffilter	4	169951
filter water separator Filter Wasserabscheider	4	176434
V-belt Keilriemen	2	172327
filter safety cartridge Filter Sicherheitspatrone	2	167974
filter replacement cartridge Filter Austauschpatrone	2	187692
filter heater Filter Heizung	2	107202
filter heater, outside Filter Heizung (außen)	2	107060
ventilation filter Belüftungsfilter	2	153955
leakage oil filter Leckölfilter	2	027376
auxiliary control filter Vorsteuerfilter	2	150308
line filter Speisedruckfilter	2	154947
return flow filter Rücklauffilter	2	150307
filter crankcase ventilation Filter Kurbelgehäuseentlüftung	1	169954
224404 inspection set (2000 h) / Inspektionssatz (2000 h) 723E (QSB 4.5 Tier 4f / IV, HC)		
engine oil filter Motorölfilter	4	106924
fuel filter Kraftstofffilter	4	169951
filter water separator Filter Wasserabscheider	4	176434
V-belt Keilriemen	2	172327
filter safety cartridge Filter Sicherheitspatrone	2	167974
filter replacement cartridge Filter Austauschpatrone	2	187692
filter heater Filter Heizung	2	107202
filter heater, outside Filter Heizung (außen)	2	107060
ventilation filter Belüftungsfilter	2	153955
leakage oil filter Leckölfilter	2	027376
HydroClean HydroClean	2	150309
line filter Speisedruckfilter	2	154947

Description / Bezeichnung	Qty. / St.	No. / Nr.
return flow filter Rücklauffilter	2	150307
filter crankcase ventilation Filter Kurbelgehäuseentlüftung	1	169954
224546 inspection set (2000 h) / Inspektionssatz (2000 h) 730E (QSB 6.7 Tier 4f / IV, HC)		
engine oil filter Motorölfilter	4	106924
fuel filter Kraftstofffilter	4	169951
filter water separator Filter Wasserabscheider	4	176434
V-belt Keilriemen	2	167976
V-belt Keilriemen	2	161492
filter safety cartridge Filter Sicherheitspatrone	2	167974
filter replacement cartridge Filter Austauschpatrone	2	167973
filter heater Filter Heizung	2	107202
filter heater, outside Filter Heizung (außen)	2	107060
ventilation filter Belüftungsfilter	2	153955
leakage oil filter Leckölfilter	2	027376
HydroClean HydroClean	2	150309
line filter Speisedruckfilter	2	154947
return flow filter Rücklauffilter	4	150307
filter crankcase ventilation Filter Kurbelgehäuseentlüftung	1	169482
ventilation filter Belüftungsfilter	1	168306
254322 inspection set (2000 h) / Inspektionssatz (2000 h) 735E (QSL 9 Tier 3a, VF)		
ventilation filter Belüftungsfilter	2	153955
auxiliary control filter Vorsteuerfilter	2	150308
leakage oil filter Leckölfilter	2	027376
line filter Speisedruckfilter	2	154947
return flow filter Rücklauffilter	4	150307
breather filter Entlüftungsfilter	2	168306
engine oil filter Motorölfilter	4	157835
fuel filter Kraftstofffilter	4	189578
water filter Kühlwasserfilter	4	158319
filter water separator Filter Wasserabscheider	4	176434
filter heater, outside Filter Heizung, außen	2	107060
filter heater, inside Filter Heizung, innen	2	107202
air filter replacement cartridge Austauschpatrone Luftfilter	4	205230
air filter safety cartridge Sicherheitspatrone Luftfilter	4	205231
V-belt Keilriemen	2	081733
V-belt Keilriemen	2	189579

14.5 INSPECTION SETS (2000 H) / INSPEKTIONSSÄTZE (2000 H)

Description / Bezeichnung	Qty. / St.	No. / Nr.
254323 inspection set (2000 h) / Inspektionssatz (2000 h) 735E (QSL 9 Tier 3a, HC)		
ventilation filter BelüftungsfILTER	2	153955
HydroClean HydroClean	2	150309
leakage oil filter Leckölfilter	2	027376
line filter Speisedruckfilter	2	154947
return flow filter Rücklauffilter	4	150307
breather filter EntlüftungsfILTER	2	168306
engine oil filter Motorölfilter	4	157835
fuel filter Kraftstofffilter	4	189578
water filter Kühlwasserfilter	4	158319
filter water separator Filter Wasserabscheider	4	176434
filter heater, outside Filter Heizung, außen	2	107060
filter heater, inside Filter Heizung, innen	2	107202
air filter replacement cartridge Austauschpatrone Luftfilter	4	205230
air filter safety cartridge Sicherheitspatrone Luftfilter	4	205231
V-belt Keilriemen	2	081733
V-belt Keilriemen	2	189579
231021 inspection set (2000 h) / Inspektionssatz (2000 h) 735E (QSL 9 Tier 4f / IV, VF)		
engine oil filter Motorölfilter	4	157835
fuel filter Kraftstofffilter	4	169951
filter water separator Filter Wasserabscheider	4	176434
V-belt Keilriemen	2	158322
V-belt Keilriemen	2	081733
filter safety cartridge Filter Sicherheitspatrone	2	157839
filter replacement cartridge Filter Austauschpatrone	2	157840
filter heater Filter Heizung	2	107202
filter heater, outside Filter Heizung (außen)	2	107060
ventilation filter BelüftungsfILTER	2	153955
leakage oil filter Leckölfilter	2	027376
auxiliary control filter Vorsteuerfilter	2	150308
line filter Speisedruckfilter	2	154947
return flow filter Rücklauffilter	4	150307
filter crankcase ventilation Filter Kurbelgehäuseentlüftung	1	169483
water filter Kühlwasserfilter	4	158319
201238 inspection set (2000 h) / Inspektionssatz (2000 h) 735E (QSL 9 Tier 4f / IV, HC)		
engine oil filter Motorölfilter	4	157835
fuel filter Kraftstofffilter	4	169951
filter water separator Filter Wasserabscheider	4	176434
V-belt Keilriemen	2	158322

Description / Bezeichnung	Qty. / St.	No. / Nr.
V-belt Keilriemen	2	081733
filter safety cartridge Filter Sicherheitspatrone	2	157839
filter replacement cartridge Filter Austauschpatrone	2	157840
filter heater Filter Heizung	2	107202
filter heater, outside Filter Heizung (außen)	2	107060
ventilation filter BelüftungsfILTER	2	153955
leakage oil filter Leckölfilter	2	027376
HydroClean HydroClean	2	150309
line filter Speisedruckfilter	2	154947
return flow filter Rücklauffilter	4	150307
filter crankcase ventilation Filter Kurbelgehäuseentlüftung	1	169483
water filter Kühlwasserfilter	4	158319
253217 inspection set (2000 h) / Inspektionssatz (2000 h) 735E (L9 EU Stage V, VF)		
return flow filter Rücklauffilter	4	150307
leakage oil filter Leckölfilter	2	027376
ventilation filter BelüftungsfILTER	2	153955
auxiliary control filter Vorsteuerfilter	2	150308
breather filter EntlüftungsfILTER	2	168306
engine oil filter Motorölfilter	4	244361
fuel filter Kraftstofffilter	4	169951
filter water separator Filter Wasserabscheider	4	176434
air filter safety cartridge Sicherheitspatrone Luftfilter	4	205231
air filter replacement cartridge Austauschpatrone Luftfilter	4	205230
V-belt Keilriemen	1	158322
V-belt Keilriemen	1	081733
line filter Speisedruckfilter	2	154947
filter heater, inside Filter Heizung, innen	2	107202
filter heater, outside Filter Heizung, außen	2	107060
water filter Kühlwasserfilter	4	158319
253218 inspection set (2000 h) / Inspektionssatz (2000 h) 735E (L9 EU Stage V, HC)		
return flow filter Rücklauffilter	4	150307
leakage oil filter Leckölfilter	2	027376
ventilation filter BelüftungsfILTER	2	153955
HydroClean HydroClean	2	150309
breather filter EntlüftungsfILTER	2	168306
engine oil filter Motorölfilter	4	244361
fuel filter Kraftstofffilter	4	169951
filter water separator Filter Wasserabscheider	4	176434

Description / Bezeichnung	Qty. / St.	No. / Nr.
air filter safety cartridge Sicherheitspatrone Luftfilter	4	205231
air filter replacement cartridge Austauschpatrone Luftfilter	4	205230
filter heater, inside Filter Heizung, innen	2	107202
filter heater, outside Filter Heizung, außen	2	107060
V-belt Keilriemen	1	158322
V-belt Keilriemen	1	081733
line filter Speisedruckfilter	2	154947
water filter Kühlwasserfilter	4	158319
238777 inspection set (2000 h) / Inspektionssatz (2000 h) 817E (FPT N45 Tier 4f, VF)		
return flow filter Rücklauffilter	2	150307
leakage oil filter Leckölfilter	2	027376
ventilation filter BelüftungsfILTER	2	153955
breather filter EntlüftungsfILTER	2	168306
auxiliary control filter Vorsteuerfilter	2	150308
engine oil filter Motorölfilter	4	206076
fuel filter Kraftstofffilter	4	103142
filter water separator Filter Wasserabscheider	4	176434
filter air conditioner Filter Klimaanlage	2	138361
line filter Speisedruckfilter	2	154947
air filter safety cartridge Sicherheitspatrone Luftfilter	2	149255
air filter replacement cartridge Austauschpatrone Luftfilter	2	149256
V-belt Keilriemen	2	206782
V-belt Keilriemen	2	206172
238776 inspection set (2000 h) / Inspektionssatz (2000 h) 817E (FPT N45 Tier 4f, HC)		
return flow filter Rücklauffilter	2	150307
leakage oil filter Leckölfilter	2	027376
ventilation filter BelüftungsfILTER	2	153955
breather filter EntlüftungsfILTER	2	168306
HydroClean HydroClean	2	150309
engine oil filter Motorölfilter	4	206076
fuel filter Kraftstofffilter	4	103142
filter water separator Filter Wasserabscheider	4	176434
filter air conditioner Filter Klimaanlage	2	138361
air filter safety cartridge Sicherheitspatrone Luftfilter	2	149255
air filter replacement cartridge Austauschpatrone Luftfilter	2	149256
line filter Speisedruckfilter	2	154947
V-belt Keilriemen	2	206782
V-belt Keilriemen	2	206172

14.5 INSPECTION SETS (2000 H) / INSPEKTIONSSÄTZE (2000 H)

Description / Bezeichnung	Qty. / St.	No. / Nr.
162235 inspection set (2000 h) / Inspektionssatz (2000 h) 818D (QSB 4.5 Tier 3 / IIIA, VF, WA)		
return flow filter Rücklaufilter	2	150307
leakage oil filter Leckölfilter	2	027376
ventilation filter Belüftungsfilter	2	174541
auxiliary control filter Vorsteuerfilter	2	150308
engine oil filter Motorölfilter	4	106924
fuel filter Kraftstofffilter	4	103142
filter water separator Filter Wasserabscheider	4	103139
filter air conditioner Filter Klimaanlage	2	138361
air filter safety cartridge Sicherheitspatrone Luftfilter	2	072385
air filter replacement cartridge Austauschpatrone Luftfilter	2	072386
V-belt air conditioner Keilriemen Klimaanlage	1	116125
162236 inspection set (2000 h) / Inspektionssatz (2000 h) 818D (QSB 4.5 Tier 3 / IIIA, VF, WAH)		
return flow filter Rücklaufilter	2	150307
leakage oil filter Leckölfilter	2	027376
ventilation filter Belüftungsfilter	2	174541
auxiliary control filter Vorsteuerfilter	2	150308
engine oil filter Motorölfilter	4	106924
fuel filter Kraftstofffilter	4	103142
filter water separator, heatable Filter Wasserabscheider, beheizbar	4	109674
filter air conditioner Filter Klimaanlage	2	138361
air filter safety cartridge Sicherheitspatrone Luftfilter	2	072385
air filter replacement cartridge Austauschpatrone Luftfilter	2	072386
V-belt air conditioner Keilriemen Klimaanlage	1	116125
162237 inspection set (2000 h) / Inspektionssatz (2000 h) 818D (QSB 4.5 Tier 3 / IIIA, HC, WA)		
return flow filter Rücklaufilter	2	150307
leakage oil filter Leckölfilter	2	027376
ventilation filter Belüftungsfilter	2	174541
HydroClean HydroClean	2	150309
engine oil filter Motorölfilter	4	106924
fuel filter Kraftstofffilter	4	103142
filter water separator Filter Wasserabscheider	4	103139
filter air conditioner Filter Klimaanlage	2	138361
air filter safety cartridge Sicherheitspatrone Luftfilter	2	072385
air filter replacement cartridge Austauschpatrone Luftfilter	2	072386
V-belt air conditioner Keilriemen Klimaanlage	1	116125

Description / Bezeichnung	Qty. / St.	No. / Nr.
162238 inspection set (2000 h) / Inspektionssatz (2000 h) 818D (QSB 4.5 Tier 3 / IIIA, HC, WAH)		
return flow filter Rücklaufilter	2	150307
leakage oil filter Leckölfilter	2	027376
ventilation filter Belüftungsfilter	2	174541
HydroClean HydroClean	2	150309
engine oil filter Motorölfilter	4	106924
fuel filter Kraftstofffilter	4	103142
filter water separator, heatable Filter Wasserabscheider, beheizbar	4	109674
filter air conditioner Filter Klimaanlage	2	138361
air filter safety cartridge Sicherheitspatrone Luftfilter	2	072385
air filter replacement cartridge Austauschpatrone Luftfilter	2	072386
V-belt air conditioner Keilriemen Klimaanlage	1	116125
162239 inspection set (2000 h) / Inspektionssatz (2000 h) 821C (QSB 4.5 Tier 3 / IIIA, VF, WAH)		
return flow filter Rücklaufilter	2	150307
leakage oil filter Leckölfilter	2	027376
ventilation filter Belüftungsfilter	2	057228
auxiliary control filter Vorsteuerfilter	2	150308
engine oil filter Motorölfilter	4	106924
fuel filter Kraftstofffilter	4	103142
filter water separator Filter Wasserabscheider	4	103139
filter heater Filter Heizung	2	037257
air filter safety cartridge Sicherheitspatrone Luftfilter	2	072385
air filter replacement cartridge Austauschpatrone Luftfilter	2	072386
V-belt air conditioner Keilriemen Klimaanlage	1	116125
162240 inspection set (2000 h) / Inspektionssatz (2000 h) 821C (QSB 4.5 Tier 3 / IIIA, VF, WAH)		
return flow filter Rücklaufilter	2	150307
leakage oil filter Leckölfilter	2	027376
ventilation filter Belüftungsfilter	2	057228
auxiliary control filter Vorsteuerfilter	2	150308
engine oil filter Motorölfilter	4	106924
fuel filter Kraftstofffilter	4	103142
filter water separator, heatable Filter Wasserabscheider, beheizbar	4	109674
filter heater Filter Heizung	2	037257
air filter safety cartridge Sicherheitspatrone Luftfilter	2	072385
air filter replacement cartridge Austauschpatrone Luftfilter	2	072386
V-belt air conditioner Keilriemen Klimaanlage	1	116125

Description / Bezeichnung	Qty. / St.	No. / Nr.
162241 inspection set (2000 h) / Inspektionssatz (2000 h) 821C (QSB 4.5 Tier 3 / IIIA, HC, WA)		
return flow filter Rücklaufilter	2	150307
leakage oil filter Leckölfilter	2	027376
ventilation filter Belüftungsfilter	2	057228
HydroClean HydroClean	2	150309
engine oil filter Motorölfilter	4	106924
fuel filter Kraftstofffilter	4	103142
filter water separator Filter Wasserabscheider	4	103139
filter heater Filter Heizung	2	037257
air filter safety cartridge Sicherheitspatrone Luftfilter	2	072385
air filter replacement cartridge Austauschpatrone Luftfilter	2	072386
V-belt air conditioner Keilriemen Klimaanlage	1	116125
162242 inspection set (2000 h) / Inspektionssatz (2000 h) 821C (QSB 4.5 Tier 3 / IIIA, HC, WAH)		
return flow filter Rücklaufilter	2	150307
leakage oil filter Leckölfilter	2	027376
ventilation filter Belüftungsfilter	2	057228
HydroClean HydroClean	2	150309
engine oil filter Motorölfilter	4	106924
fuel filter Kraftstofffilter	4	103142
filter water separator, heatable Filter Wasserabscheider, beheizbar	4	109674
filter heater Filter Heizung	2	037257
air filter safety cartridge Sicherheitspatrone Luftfilter	2	072385
air filter replacement cartridge Austauschpatrone Luftfilter	2	072386
V-belt air conditioner Keilriemen Klimaanlage	1	116125
180487 inspection set (2000 h) / Inspektionssatz (2000 h) 818E, 821E (QSB 4.5 Tier 3 / IIIA, VF)		
return flow filter Rücklaufilter	2	150307
leakage oil filter Leckölfilter	2	027376
ventilation filter Belüftungsfilter	2	153955
auxiliary control filter Vorsteuerfilter	2	150308
engine oil filter Motorölfilter	4	106924
fuel filter Kraftstofffilter	4	103142
filter water separator Filter Wasserabscheider	4	103139
line filter Speisedruckfilter	2	154947
filter heater Filter Heizung	2	107202
filter heater, outside Filter Heizung (außen)	2	107060
air filter safety cartridge Sicherheitspatrone Luftfilter	2	064200
air filter replacement cartridge Austauschpatrone Luftfilter	2	118606
V-belt air conditioner Keilriemen Klimaanlage	2	116125

14.5 INSPECTION SETS (2000 H) / INSPEKTIONSSÄTZE (2000 H)

Description / Bezeichnung	Qty. / St.	No. / Nr.
180488 inspection set (2000 h) / Inspektionssatz (2000 h) 818E, 821E (QSB 4.5 Tier 3 / IIIA, HC)		
return flow filter Rücklauffilter	2	150307
leakage oil filter Leckölfilter	2	027376
ventilation filter Belüftungsfilter	2	153955
HydroClean HydroClean	2	150309
engine oil filter Motorölfilter	4	106924
fuel filter Kraftstofffilter	4	103142
filter water separator Filter Wasserabscheider	4	103139
line filter Speisedruckfilter	2	154947
filter heater Filter Heizung	2	107202
filter heater, outside Filter Heizung (außen)	2	107060
air filter safety cartridge Sicherheitspatrone Luftfilter	2	064200
air filter replacement cartridge Austauschpatrone Luftfilter	2	118606
V-belt air conditioner Keilriemen Klimaanlage	2	116125
180485 inspection set (2000 h) / Inspektionssatz (2000 h) 818E, 821E (QSB 4.5 Tier 4i / IIIB, VF)		
return flow filter Rücklauffilter	2	150307
leakage oil filter Leckölfilter	2	027376
ventilation filter Belüftungsfilter	2	153955
auxiliary control filter Vorsteuerfilter	2	150308
engine oil filter Motorölfilter	4	106924
fuel filter Kraftstofffilter	4	169951
filter water separator Filter Wasserabscheider	4	158317
filter crankcase ventilation Filter Kurbelgehäuseentlüftung	1	169954
line filter Speisedruckfilter	2	154947
filter heater Filter Heizung	2	107202
filter heater, outside Filter Heizung (außen)	2	107060
filter safety cartridge Filter Sicherheitspatrone	2	169953
filter replacement cartridge Filter Austauschpatrone	2	169952
V-belt air conditioner Keilriemen Klimaanlage	2	172327
180486 inspection set (2000 h) / Inspektionssatz (2000 h) 818E, 821E (QSB 4.5 Tier 4i / IIIB, HC)		
return flow filter Rücklauffilter	2	150307
leakage oil filter Leckölfilter	2	027376
ventilation filter Belüftungsfilter	2	153955
HydroClean HydroClean	2	150309
engine oil filter Motorölfilter	4	106924
fuel filter Kraftstofffilter	4	169951
filter water separator Filter Wasserabscheider	4	158317
filter crankcase ventilation Filter Kurbelgehäuseentlüftung	1	169954

Description / Bezeichnung	Qty. / St.	No. / Nr.
line filter Speisedruckfilter	2	154947
filter heater Filter Heizung	2	107202
filter heater, outside Filter Heizung (außen)	2	107060
filter safety cartridge Filter Sicherheitspatrone	2	169953
filter replacement cartridge Filter Austauschpatrone	2	169952
V-belt air conditioner Keilriemen Klimaanlage	2	172327
219479 inspection set (2000 h) / Inspektionssatz (2000 h) 818E, 821E (QSB 4.5 Tier 4f / IV, VF)		
engine oil filter Motorölfilter	4	106924
fuel filter Kraftstofffilter	4	169951
filter water separator Filter Wasserabscheider	4	176434
V-belt Keilriemen	2	172327
filter safety cartridge Filter Sicherheitspatrone	2	167974
filter replacement cartridge Filter Austauschpatrone	2	187692
filter heater Filter Heizung	2	107202
filter heater, outside Filter Heizung (außen)	2	107060
ventilation filter Belüftungsfilter	2	153955
leakage oil filter Leckölfilter	2	027376
auxiliary control filter Vorsteuerfilter	2	150308
line filter Speisedruckfilter	2	154947
return flow filter Rücklauffilter	2	150307
filter crankcase ventilation Filter Kurbelgehäuseentlüftung	1	169954
219480 inspection set (2000 h) / Inspektionssatz (2000 h) 818E, 821E (QSB 4.5 Tier 4f / IV, HC)		
engine oil filter Motorölfilter	4	106924
fuel filter Kraftstofffilter	4	169951
filter water separator Filter Wasserabscheider	4	176434
V-belt Keilriemen	2	172327
filter safety cartridge Filter Sicherheitspatrone	2	167974
filter replacement cartridge Filter Austauschpatrone	2	187692
filter heater Filter Heizung	2	107202
filter heater, outside Filter Heizung (außen)	2	107060
ventilation filter Belüftungsfilter	2	153955
leakage oil filter Leckölfilter	2	027376
HydroClean HydroClean	2	150309
line filter Speisedruckfilter	2	154947
return flow filter Rücklauffilter	2	150307
filter crankcase ventilation Filter Kurbelgehäuseentlüftung	1	169954

Description / Bezeichnung	Qty. / St.	No. / Nr.
162243 inspection set (2000 h) / Inspektionssatz (2000 h) 825D, 830D (QSB 6.7 Tier 3 / IIIA, VF, WA)		
return flow filter Rücklauffilter	4	150307
leakage oil filter Leckölfilter	2	027376
ventilation filter Belüftungsfilter	2	174541
auxiliary control filter Vorsteuerfilter	2	150308
engine oil filter Motorölfilter	4	106924
fuel filter Kraftstofffilter	4	103142
filter water separator Filter Wasserabscheider	4	103139
filter heater Filter Heizung	2	107202
filter heater, outside Filter Heizung (außen)	2	107060
air filter safety cartridge Sicherheitspatrone Luftfilter	2	064200
air filter replacement cartridge Austauschpatrone Luftfilter	2	118606
V-belt air conditioner Keilriemen Klimaanlage	1	106925
162244 inspection set (2000 h) / Inspektionssatz (2000 h) 825D, 830D (QSB 6.7 Tier 3 / IIIA, VF, WAH)		
return flow filter Rücklauffilter	4	150307
leakage oil filter Leckölfilter	2	027376
ventilation filter Belüftungsfilter	2	174541
auxiliary control filter Vorsteuerfilter	2	150308
engine oil filter Motorölfilter	4	106924
fuel filter Kraftstofffilter	4	103142
filter water separator, heatable Filter Wasserabscheider, beheizbar	4	109674
filter heater Filter Heizung	2	107202
filter heater, outside Filter Heizung (außen)	2	107060
air filter safety cartridge Sicherheitspatrone Luftfilter	2	064200
air filter replacement cartridge Austauschpatrone Luftfilter	2	118606
V-belt air conditioner Keilriemen Klimaanlage	1	106925
162245 inspection set (2000 h) / Inspektionssatz (2000 h) 825D, 830D (QSB 6.7 Tier 3 / IIIA, HC, WA)		
return flow filter Rücklauffilter	4	150307
leakage oil filter Leckölfilter	2	027376
ventilation filter Belüftungsfilter	2	174541
HydroClean HydroClean	2	150309
engine oil filter Motorölfilter	4	106924
fuel filter Kraftstofffilter	4	103142
filter water separator Filter Wasserabscheider	4	103139
filter heater Filter Heizung	2	107202
filter heater, outside Filter Heizung (außen)	2	107060
air filter safety cartridge Sicherheitspatrone Luftfilter	2	064200
air filter replacement cartridge Austauschpatrone Luftfilter	2	118606
V-belt air conditioner Keilriemen Klimaanlage	1	106925

14.5 INSPECTION SETS (2000 H) / INSPEKTIONSSÄTZE (2000 H)

Description / Bezeichnung	Qty. / St.	No. / Nr.
162246 inspection set (2000 h) / Inspektionssatz (2000 h) 825D, 830D (QSB 6.7 Tier 3 / IIIA, HC, WAH)		
return flow filter Rücklauffilter	4	150307
leakage oil filter Leckölfilter	2	027376
ventilation filter Belüftungsfilter	2	174541
HydroClean HydroClean	2	150309
engine oil filter Motorölfilter	4	106924
fuel filter Kraftstofffilter	4	103142
filter water separator, heatable Filter Wasserabscheider, beheizbar	4	109674
filter heater Filter Heizung	2	107202
filter heater, outside Filter Heizung (außen)	2	107060
air filter safety cartridge Sicherheitspatrone Luftfilter	2	064200
air filter replacement cartridge Austauschpatrone Luftfilter	2	118606
V-belt air conditioner Keilriemen Klimaanlage	1	106925
234013 inspection set (2000 h) / Inspektionssatz (2000 h) 825E, 830E (QSB 6.7 Tier 3 / IIIA, VF)		
return flow filter Rücklauffilter	4	150307
leakage oil filter Leckölfilter	2	027376
ventilation filter Belüftungsfilter	2	153955
auxiliary control filter Vorsteuerfilter	2	150308
engine oil filter Motorölfilter	4	106924
fuel filter Kraftstofffilter	4	103142
filter water separator Filter Wasserabscheider	4	176434
line filter Speisedruckfilter	2	154947
filter heater, inside Filter Heizung, innen	2	107202
filter heater, outside Filter Heizung, außen	2	107060
air filter safety cartridge Sicherheitspatrone Luftfilter	2	167974
air filter replacement cartridge Austauschpatrone Luftfilter	2	167973
V-belt Keilriemen	2	167976
V-belt Keilriemen	2	161492
234014 inspection set (2000 h) / Inspektionssatz (2000 h) 825E, 830E (QSB 6.7 Tier 3 / IIIA, HC)		
return flow filter Rücklauffilter	4	150307
leakage oil filter Leckölfilter	2	027376
ventilation filter Belüftungsfilter	2	153955
HydroClean HydroClean	2	150309
engine oil filter Motorölfilter	4	106924
fuel filter Kraftstofffilter	4	103142
filter water separator Filter Wasserabscheider	4	176434
line filter Speisedruckfilter	2	154947
filter heater, inside Filter Heizung, innen	2	107202

Description / Bezeichnung	Qty. / St.	No. / Nr.
filter heater, outside Filter Heizung, außen	2	107060
air filter safety cartridge Sicherheitspatrone Luftfilter	2	167974
air filter replacement cartridge Austauschpatrone Luftfilter	2	167973
V-belt Keilriemen	2	167976
V-belt Keilriemen	2	161492
201824 inspection set (2000 h) / Inspektionssatz (2000 h) 830E (bis 830.x.2148, Tier 4i / IIIB, VF)		
return flow filter Rücklauffilter	4	150307
leakage oil filter Leckölfilter	2	027376
ventilation filter Belüftungsfilter	2	153955
auxiliary control filter Vorsteuerfilter	2	150308
engine oil filter Motorölfilter	4	106924
fuel filter Kraftstofffilter	4	167975
filter water separator Filter Wasserabscheider	4	158317
filter crankcase ventilation Filter Kurbelgehäuseentlüftung	1	169482
line filter Speisedruckfilter	2	154947
filter heater, inside Filter Heizung, innen	2	107202
filter heater, outside Filter Heizung, außen	2	107060
air filter safety cartridge Sicherheitspatrone Luftfilter	2	167974
air filter replacement cartridge Austauschpatrone Luftfilter	2	167973
V-belt Keilriemen	2	167976
V-belt Keilriemen	2	161492
201825 inspection set (2000 h) / Inspektionssatz (2000 h) 830E (bis 830.x.2148, Tier 4i / IIIB, HC)		
return flow filter Rücklauffilter	4	150307
leakage oil filter Leckölfilter	2	027376
ventilation filter Belüftungsfilter	2	153955
HydroClean HydroClean	2	150309
engine oil filter Motorölfilter	4	106924
fuel filter Kraftstofffilter	4	167975
filter water separator Filter Wasserabscheider	4	158317
filter crankcase ventilation Filter Kurbelgehäuseentlüftung	1	169482
line filter Speisedruckfilter	2	154947
filter heater, inside Filter Heizung, innen	2	107202
filter heater, outside Filter Heizung, außen	2	107060
air filter safety cartridge Sicherheitspatrone Luftfilter	2	167974
air filter replacement cartridge Austauschpatrone Luftfilter	2	167973
V-belt Keilriemen	2	167976
V-belt Keilriemen	2	161492

Description / Bezeichnung	Qty. / St.	No. / Nr.
180555 inspection set (2000 h) / Inspektionssatz (2000 h) 830E (QSB 6.7 Tier 4i / IIIB, VF)		
return flow filter Rücklauffilter	4	150307
leakage oil filter Leckölfilter	2	027376
ventilation filter Belüftungsfilter	2	153955
auxiliary control filter Vorsteuerfilter	2	150308
engine oil filter Motorölfilter	4	106924
fuel filter Kraftstofffilter	4	167975
filter water separator Filter Wasserabscheider	4	158317
filter crankcase ventilation Filter Kurbelgehäuseentlüftung	1	169482
line filter Speisedruckfilter	2	154947
filter heater Filter Heizung	2	107202
filter heater, outside Filter Heizung (außen)	2	107060
filter safety cartridge Filter Sicherheitspatrone	2	167974
filter replacement cartridge Filter Austauschpatrone	2	167973
V-belt Keilriemen	2	167976
V-belt air conditioner Keilriemen Klimaanlage	2	161492
180556 inspection set (2000 h) / Inspektionssatz (2000 h) 830E (QSB 6.7 Tier 4i / IIIB, HC)		
return flow filter Rücklauffilter	4	150307
leakage oil filter Leckölfilter	2	027376
ventilation filter Belüftungsfilter	2	153955
HydroClean HydroClean	2	150309
engine oil filter Motorölfilter	4	106924
fuel filter Kraftstofffilter	4	167975
filter water separator Filter Wasserabscheider	4	158317
filter crankcase ventilation Filter Kurbelgehäuseentlüftung	1	169482
line filter Speisedruckfilter	2	154947
filter heater Filter Heizung	2	107202
filter heater, outside Filter Heizung (außen)	2	107060
filter safety cartridge Filter Sicherheitspatrone	2	167974
filter replacement cartridge Filter Austauschpatrone	2	167973
V-belt Keilriemen	2	167976
V-belt air conditioner Keilriemen Klimaanlage	2	161492

14.5 INSPECTION SETS (2000 H) / INSPEKTIONSSÄTZE (2000 H)

Description / Bezeichnung	Qty. / St.	No. / Nr.
198394 inspection set (2000 h) / Inspektionssatz (2000 h) 825E, 830E (QSB 6.7 Tier 4f / IV, VF)		
return flow filter Rücklauffilter	4	150307
leakage oil filter Leckölfilter	2	027376
ventilation filter Belüftungsfilter	2	153955
auxiliary control filter Vorsteuerfilter	2	150308
engine oil filter Motorölfilter	4	106924
fuel filter Kraftstofffilter	4	169951
filter water separator Filter Wasserabscheider	4	176434
filter crankcase ventilation Filter Kurbelgehäuseentlüftung	1	169482
line filter Speisedruckfilter	2	154947
filter heater Filter Heizung	2	107202
filter heater, outside Filter Heizung (außen)	2	107060
filter safety cartridge Filter Sicherheitspatrone	2	167974
filter replacement cartridge Filter Austauschpatrone	2	167973
V-belt Keilriemen	2	167976
V-belt air conditioner Keilriemen Klimaanlage	2	161492
198395 inspection set (2000 h) / Inspektionssatz (2000 h) 825E, 830E (QSB 6.7 Tier 4f / IV, HC)		
return flow filter Rücklauffilter	4	150307
leakage oil filter Leckölfilter	2	027376
ventilation filter Belüftungsfilter	2	153955
HydroClean HydroClean	2	150309
engine oil filter Motorölfilter	4	106924
fuel filter Kraftstofffilter	4	169951
filter water separator Filter Wasserabscheider	4	176434
filter crankcase ventilation Filter Kurbelgehäuseentlüftung	1	169482
line filter Speisedruckfilter	2	154947
filter heater Filter Heizung	2	107202
filter heater, outside Filter Heizung (außen)	2	107060
filter safety cartridge Filter Sicherheitspatrone	2	167974
filter replacement cartridge Filter Austauschpatrone	2	167973
V-belt Keilriemen	2	167976
V-belt air conditioner Keilriemen Klimaanlage	2	161492
247943 inspection set (2000 h) / Inspektionssatz (2000 h) 825E, 830E (B 6.7 EU Stage V, VF)		
return flow filter Rücklauffilter	4	150307
leakage oil filter Leckölfilter	2	027376
ventilation filter Belüftungsfilter	2	153955

Description / Bezeichnung	Qty. / St.	No. / Nr.
auxiliary control filter Vorsteuerfilter	2	150308
breather filter Entlüftungsfilter	2	168306
engine oil filter Motorölfilter	5	106924
fuel filter Kraftstofffilter	5	169951
filter water separator Filter Wasserabscheider	5	176434
air filter safety cartridge Sicherheitspatrone Luftfilter	2	167974
air filter replacement cartridge Austauschpatrone Luftfilter	2	167973
filter heater, inside Filter Heizung, innen	2	107202
filter heater, outside Filter Heizung, außen	2	107060
V-belt Keilriemen	2	167976
V-belt Keilriemen	2	161492
line filter Speisedruckfilter	2	154947
suction filter Ansaugfilter	1	205787
247942 inspection set (2000 h) / Inspektionssatz (2000 h) 825E, 830E (B 6.7 EU Stage V, HC)		
return flow filter Rücklauffilter	4	150307
leakage oil filter Leckölfilter	2	027376
ventilation filter Belüftungsfilter	2	153955
HydroClean HydroClean	2	150309
breather filter Entlüftungsfilter	2	168306
engine oil filter Motorölfilter	5	106924
fuel filter Kraftstofffilter	5	169951
filter water separator Filter Wasserabscheider	5	176434
air filter safety cartridge Sicherheitspatrone Luftfilter	2	167974
air filter replacement cartridge Austauschpatrone Luftfilter	2	167973
filter heater, inside Filter Heizung, innen	2	107202
filter heater, outside Filter Heizung, außen	2	107060
V-belt Keilriemen	2	167976
V-belt Keilriemen	2	161492
line filter Speisedruckfilter	2	154947
suction filter Ansaugfilter	1	205787
162247 inspection set (2000 h) / Inspektionssatz (2000 h) 835D, 840D (QSB 6.7 Tier 3 / IIIA, VF, WA)		
return flow filter Rücklauffilter	4	150307
leakage oil filter Leckölfilter	2	027376
ventilation filter Belüftungsfilter	2	174541
auxiliary control filter Vorsteuerfilter	2	150308
engine oil filter Motorölfilter	4	106924

Description / Bezeichnung	Qty. / St.	No. / Nr.
fuel filter Kraftstofffilter	4	103142
filter water separator Filter Wasserabscheider	4	103139
filter heater Filter Heizung	2	107202
filter heater, outside Filter Heizung (außen)	2	107060
air filter safety cartridge Sicherheitspatrone Luftfilter	2	068827
air filter replacement cartridge Austauschpatrone Luftfilter	2	068826
V-belt air conditioner Keilriemen Klimaanlage	1	106925
162248 inspection set (2000 h) / Inspektionssatz (2000 h) 835D, 840D (QSB 6.7 Tier 3 / IIIA, VF, WAH)		
return flow filter Rücklauffilter	4	150307
leakage oil filter Leckölfilter	2	027376
ventilation filter Belüftungsfilter	2	174541
auxiliary control filter Vorsteuerfilter	2	150308
engine oil filter Motorölfilter	4	106924
fuel filter Kraftstofffilter	4	103142
filter water separator, heatable Filter Wasserabscheider, beheizbar	4	109674
filter heater Filter Heizung	2	107202
filter heater, outside Filter Heizung (außen)	2	107060
air filter safety cartridge Sicherheitspatrone Luftfilter	2	068827
air filter replacement cartridge Austauschpatrone Luftfilter	2	068826
V-belt air conditioner Keilriemen Klimaanlage	1	106925
162249 inspection set (2000 h) / Inspektionssatz (2000 h) 835D, 840D (QSB 6.7 Tier 3 / IIIA, HC, WA)		
return flow filter Rücklauffilter	4	150307
leakage oil filter Leckölfilter	2	027376
ventilation filter Belüftungsfilter	2	174541
HydroClean HydroClean	2	150309
engine oil filter Motorölfilter	4	106924
fuel filter Kraftstofffilter	4	103142
filter water separator Filter Wasserabscheider	4	103139
filter heater Filter Heizung	2	107202
filter heater, outside Filter Heizung (außen)	2	107060
air filter safety cartridge Sicherheitspatrone Luftfilter	2	068827
air filter replacement cartridge Austauschpatrone Luftfilter	2	068826
V-belt air conditioner Keilriemen Klimaanlage	1	106925

14.5 INSPECTION SETS (2000 H) / INSPEKTIONSSÄTZE (2000 H)

Description / Bezeichnung	Qty. / St.	No. / Nr.
162250 inspection set (2000 h) / Inspektionssatz (2000 h) 835D, 840D (QSB 6.7 Tier 3 / IIIA, HC, WAH)		
return flow filter Rücklauffilter	4	150307
leakage oil filter Leckölfilter	2	027376
ventilation filter Belüftungsfilter	2	174541
HydroClean HydroClean	2	150309
engine oil filter Motorölfilter	4	106924
fuel filter Kraftstofffilter	4	103142
filter water separator, heatable Filter Wasserabscheider, beheizbar	4	109674
filter heater Filter Heizung	2	107202
filter heater, outside Filter Heizung (außen)	2	107060
air filter safety cartridge Sicherheitspatrone Luftfilter	2	068827
air filter replacement cartridge Austauschpatrone Luftfilter	2	068826
V-belt air conditioner Keilriemen Klimaanlage	1	106925
252388 inspection set (2000 h) / Inspektionssatz (2000 h) 835E (QSL9 Tier 3 / IIIA, VF)		
return flow filter Rücklauffilter	2	151945
leakage oil filter Leckölfilter	2	027376
ventilation filter Belüftungsfilter	2	153955
breather filter Entlüftungsfilter	2	168306
auxiliary control filter Vorsteuerfilter	2	150308
engine oil filter Motorölfilter	4	157835
fuel filter Kraftstofffilter	4	189578
filter water separator Filter Wasserabscheider	4	176434
air filter safety cartridge Sicherheitspatrone Luftfilter	2	205231
air filter replacement cartridge Austauschpatrone Luftfilter	2	205230
V-belt Keilriemen	2	081733
V-belt Keilriemen	2	189579
filter heater, outside Filter Heizung, außen	2	107060
filter heater, inside Filter Heizung, innen	2	107202
line filter Speisedruckfilter	2	154947
water filter Kühlwasserfilter	4	158319
252389 inspection set (2000 h) / Inspektionssatz (2000 h) 835E (QSL9 Tier 3 / IIIA, HC)		
return flow filter Rücklauffilter	2	151945
leakage oil filter Leckölfilter	2	027376
ventilation filter Belüftungsfilter	2	153955
breather filter Entlüftungsfilter	2	168306
HydroClean HydroClean	2	150309
engine oil filter Motorölfilter	4	157835
fuel filter Kraftstofffilter	4	189578

Description / Bezeichnung	Qty. / St.	No. / Nr.
filter water separator Filter Wasserabscheider	4	176434
air filter safety cartridge Sicherheitspatrone Luftfilter	2	205231
air filter replacement cartridge Austauschpatrone Luftfilter	2	205230
V-belt Keilriemen	2	081733
V-belt Keilriemen	2	189579
filter heater, outside Filter Heizung, außen	2	107060
filter heater, inside Filter Heizung, innen	2	107202
line filter Speisedruckfilter	2	154947
water filter Kühlwasserfilter	4	158319
180585 inspection set (2000 h) / Inspektionssatz (2000 h) 835E, 840E (QSL 9 Tier 4i / IIIB, VF)		
engine oil filter Motorölfilter	4	157835
fuel filter Kraftstofffilter	4	158318
filter water separator Filter Wasserabscheider	4	158317
auxiliary control filter Vorsteuerfilter	2	150308
water filter Kühlwasserfilter	4	158319
filter crankcase ventilation Filter Kurbelgehäuseentlüftung	1	169483
V-belt fan Keilriemen Lüfter	2	158322
V-belt air conditioner Keilriemen Klimaanlage	2	081733
filter safety cartridge Filter Sicherheitspatrone	2	157839
filter replacement cartridge Filter Austauschpatrone	2	157840
line filter Speisedruckfilter	2	154947
return flow filter Rücklauffilter	2	151945
leakage oil filter Leckölfilter	2	027376
ventilation filter Belüftungsfilter	2	153955
filter heater Filter Heizung	2	107202
filter heater, outside Filter Heizung (außen)	2	107060
180586 inspection set (2000 h) / Inspektionssatz (2000 h) 835E, 840E (QSL 9 Tier 4i / IIIB, HC)		
engine oil filter Motorölfilter	4	157835
fuel filter Kraftstofffilter	4	158318
filter water separator Filter Wasserabscheider	4	158317
HydroClean HydroClean	2	150309
water filter Kühlwasserfilter	4	158319
filter crankcase ventilation Filter Kurbelgehäuseentlüftung	1	169483
V-belt fan Keilriemen Lüfter	2	158322
V-belt air conditioner Keilriemen Klimaanlage	2	081733
filter safety cartridge Filter Sicherheitspatrone	2	157839
filter replacement cartridge Filter Austauschpatrone	2	157840
line filter Speisedruckfilter	2	154947

Description / Bezeichnung	Qty. / St.	No. / Nr.
return flow filter Rücklauffilter	2	151945
leakage oil filter Leckölfilter	2	027376
ventilation filter Belüftungsfilter	2	153955
filter heater Filter Heizung	2	107202
filter heater, outside Filter Heizung (außen)	2	107060
187501 inspection set (2000 h) / Inspektionssatz (2000 h) 835E, 840E (QSL 9 Tier 4f / IV, VF)		
engine oil filter Motorölfilter	4	157835
fuel filter Kraftstofffilter	4	169951
filter water separator Filter Wasserabscheider	4	176434
auxiliary control filter Vorsteuerfilter	2	150308
water filter Kühlwasserfilter	4	158319
filter crankcase ventilation Filter Kurbelgehäuseentlüftung	1	169483
V-belt fan Keilriemen Lüfter	2	158322
V-belt air conditioner Keilriemen Klimaanlage	2	081733
filter safety cartridge Filter Sicherheitspatrone	2	157839
filter replacement cartridge Filter Austauschpatrone	2	157840
line filter Speisedruckfilter	2	154947
return flow filter Rücklauffilter	2	151945
leakage oil filter Leckölfilter	2	027376
ventilation filter Belüftungsfilter	2	153955
filter heater Filter Heizung	2	107202
filter heater, outside Filter Heizung (außen)	2	107060
187502 inspection set (2000 h) / Inspektionssatz (2000 h) 835E, 840E (QSL 9 Tier 4f / IV, HC)		
engine oil filter Motorölfilter	4	157835
fuel filter Kraftstofffilter	4	169951
filter water separator Filter Wasserabscheider	4	176434
HydroClean HydroClean	2	150309
water filter Kühlwasserfilter	4	158319
filter crankcase ventilation Filter Kurbelgehäuseentlüftung	1	169483
V-belt fan Keilriemen Lüfter	2	158322
V-belt air conditioner Keilriemen Klimaanlage	2	081733
filter safety cartridge Filter Sicherheitspatrone	2	157839
filter replacement cartridge Filter Austauschpatrone	2	157840
line filter Speisedruckfilter	2	154947
return flow filter Rücklauffilter	2	151945
leakage oil filter Leckölfilter	2	027376
ventilation filter Belüftungsfilter	2	153955
filter heater Filter Heizung	2	107202
filter heater, outside Filter Heizung (außen)	2	107060

14.5 INSPECTION SETS (2000 H) / INSPEKTIONSSÄTZE (2000 H)

Description / Bezeichnung	Qty. / St.	No. / Nr.
249526 inspection set (2000 h) / Inspektionssatz (2000 h) 835E, 840E (L9 EU Stage V, VF)		
return flow filter Rücklauffilter	2	151945
leakage oil filter Leckölfilter	2	027376
ventilation filter Belüftungsfilter	2	153955
auxiliary control filter Vorsteuerfilter	2	150308
line filter Speisedruckfilter	2	154947
breather filter Entlüftungsfilter	2	168306
engine oil filter Motorölfilter	4	244361
fuel filter Kraftstofffilter	4	169951
filter water separator Filter Wasserabscheider	4	176434
water filter Kühlwasserfilter	4	158319
filter heater, outside Filter Heizung, außen	2	107060
filter heater, inside Filter Heizung, innen	2	107202
air filter safety cartridge Sicherheitspatrone Luftfilter	4	205231
air filter replacement cartridge Austauschpatrone Luftfilter	4	205230
V-belt Keilriemen	1	081733
V-belt Keilriemen	1	158322
249525 inspection set (2000 h) / Inspektionssatz (2000 h) 835E, 840E (L9 EU Stage V, HC)		
return flow filter Rücklauffilter	2	151945
leakage oil filter Leckölfilter	2	027376
ventilation filter Belüftungsfilter	2	153955
HydroClean HydroClean	2	150309
line filter Speisedruckfilter	2	154947
breather filter Entlüftungsfilter	2	168306
engine oil filter Motorölfilter	4	244361
fuel filter Kraftstofffilter	4	169951
filter water separator Filter Wasserabscheider	4	176434
water filter Kühlwasserfilter	4	158319
filter heater, outside Filter Heizung, außen	2	107060
filter heater, inside Filter Heizung, innen	2	107202
air filter safety cartridge Sicherheitspatrone Luftfilter	4	205231
air filter replacement cartridge Austauschpatrone Luftfilter	4	205230
V-belt Keilriemen	1	081733
V-belt Keilriemen	1	158322
162251 inspection set (2000 h) / Inspektionssatz (2000 h) 850D, 860D (QSM 11 Tier 3 / IIIA, VF, WA)		
return flow filter Rücklauffilter	6	150307
leakage oil filter Leckölfilter	2	027376
ventilation filter Belüftungsfilter	4	174541

Description / Bezeichnung	Qty. / St.	No. / Nr.
auxiliary control filter Vorsteuerfilter	2	150308
pressure filter Druckfilter	2	154933
engine oil filter Motorölfilter	8	189624
water filter Kühlwasserfilter	8	136896
fuel filter Kraftstofffilter	8	136897
filter water separator Filter Wasserabscheider	8	103139
filter heater Filter Heizung	2	107202
filter heater, outside Filter Heizung (außen)	2	107060
air filter safety cartridge Sicherheitspatrone Luftfilter	2	068827
air filter replacement cartridge Austauschpatrone Luftfilter	2	068826
V-belt alternator Keilriemen Lichtmaschine	1	132595
V-belt alternator Keilriemen Lichtmaschine	1	132596
162252 inspection set (2000 h) / Inspektionssatz (2000 h) 850D, 860D (QSM 11 Tier 3 / IIIA, VF, WAH)		
return flow filter Rücklauffilter	6	150307
leakage oil filter Leckölfilter	2	027376
ventilation filter Belüftungsfilter	4	174541
auxiliary control filter Vorsteuerfilter	2	150308
pressure filter Druckfilter	2	154933
engine oil filter Motorölfilter	8	189624
water filter Kühlwasserfilter	8	136896
fuel filter Kraftstofffilter	8	136897
filter water separator Filter Wasserabscheider	8	165338
filter heater Filter Heizung	2	107202
filter heater, outside Filter Heizung (außen)	2	107060
air filter safety cartridge Sicherheitspatrone Luftfilter	2	068827
air filter replacement cartridge Austauschpatrone Luftfilter	2	068826
V-belt alternator Keilriemen Lichtmaschine	1	132595
V-belt alternator Keilriemen Lichtmaschine	1	132596
162253 inspection set (2000 h) / Inspektionssatz (2000 h) 850D, 860D (QSM 11 Tier 3 / IIIA, HC, WA)		
return flow filter Rücklauffilter	6	150307
leakage oil filter Leckölfilter	2	027376
ventilation filter Belüftungsfilter	4	174541
HydroClean HydroClean	2	150309
pressure filter Druckfilter	2	154933
engine oil filter Motorölfilter	8	189624
water filter Kühlwasserfilter	8	136896
fuel filter Kraftstofffilter	8	136897
filter water separator Filter Wasserabscheider	8	103139

Description / Bezeichnung	Qty. / St.	No. / Nr.
filter heater Filter Heizung	2	107202
filter heater, outside Filter Heizung (außen)	2	107060
air filter safety cartridge Sicherheitspatrone Luftfilter	2	068827
air filter replacement cartridge Austauschpatrone Luftfilter	2	068826
V-belt alternator Keilriemen Lichtmaschine	1	132595
V-belt alternator Keilriemen Lichtmaschine	1	132596
162254 inspection set (2000 h) / Inspektionssatz (2000 h) 850D, 860D (QSM 11 Tier 3 / IIIA, HC, WAH)		
return flow filter Rücklauffilter	6	150307
leakage oil filter Leckölfilter	2	027376
ventilation filter Belüftungsfilter	4	174541
HydroClean HydroClean	2	150309
pressure filter Druckfilter	2	154933
engine oil filter Motorölfilter	8	189624
water filter Kühlwasserfilter	8	136896
fuel filter Kraftstofffilter	8	136897
filter water separator Filter Wasserabscheider	8	165338
filter heater Filter Heizung	2	107202
filter heater, outside Filter Heizung (außen)	2	107060
air filter safety cartridge Sicherheitspatrone Luftfilter	2	068827
air filter replacement cartridge Austauschpatrone Luftfilter	2	068826
V-belt alternator Keilriemen Lichtmaschine	1	132595
V-belt alternator Keilriemen Lichtmaschine	1	132596
162261 inspection set (2000 h) / Inspektionssatz (2000 h) 870C (TCD 15 Tier 3 / IIIA, VF)		
return flow filter Rücklauffilter	6	150307
leakage oil filter Leckölfilter	2	027376
ventilation filter Belüftungsfilter	4	057228
auxiliary control filter Vorsteuerfilter	2	150308
engine oil filter Motorölfilter	4	179462
fuel filter Kraftstofffilter	8	089014
filter heater Filter Heizung	2	107202
filter heater, outside Filter Heizung (außen)	2	107060
filter water separator Filter Wasserabscheider	4	148781
air filter safety cartridge Sicherheitspatrone Luftfilter	2	068827
air filter replacement cartridge Austauschpatrone Luftfilter	2	068826
V-belt alternator Keilriemen Lichtmaschine	1	080188
V-belt air conditioner Keilriemen Klimaanlage	1	032090

14.5 INSPECTION SETS (2000 H) / INSPEKTIONSSÄTZE (2000 H)

Description / Bezeichnung	Qty. / St.	No. / Nr.
162263 inspection set (2000 h) / Inspektionssatz (2000 h) 870C (TCD 15 Tier 3 / IIIA, HC)		
return flow filter Rücklaufilter	6	150307
leakage oil filter Lecköfilter	2	027376
ventilation filter Belüftungsfilter	4	057228
HydroClean HydroClean	2	150309
engine oil filter Motoröfilter	4	179462
fuel filter Kraftstofffilter	8	089014
filter heater Filter Heizung	2	107202
filter heater, outside Filter Heizung (außen)	2	107060
filter water separator Filter Wasserabscheider	4	148781
air filter safety cartridge Sicherheitspatrone Luftfilter	2	068827
air filter replacement cartridge Austauschpatrone Luftfilter	2	068826
V-belt alternator Keilriemen Lichtmaschine	1	080188
V-belt air conditioner Keilriemen Klimaanlage	1	032090
162259 inspection set (2000 h) / Inspektionssatz (2000 h) 870C (CAT C11 Tier 3 / IIIA, VF)		
return flow filter Rücklaufilter	6	150307
leakage oil filter Lecköfilter	2	027376
ventilation filter Belüftungsfilter	4	057228
auxiliary control filter Vorsteuerfilter	2	150308
engine oil filter Motoröfilter	8	085693
fuel filter Kraftstofffilter	8	105680
filter heater Filter Heizung	2	107202
filter heater, outside Filter Heizung (außen)	2	107060
filter water separator Filter Wasserabscheider	8	083176
air filter safety cartridge Sicherheitspatrone Luftfilter	2	068827
air filter replacement cartridge Austauschpatrone Luftfilter	2	068826
V-belt alternator Keilriemen Lichtmaschine	1	076929
V-belt air conditioner Keilriemen Klimaanlage	1	125540
162260 inspection set (2000 h) / Inspektionssatz (2000 h) 870C (CAT C11 Tier 3 / IIIA, HC)		
return flow filter Rücklaufilter	6	150307
leakage oil filter Lecköfilter	2	027376
ventilation filter Belüftungsfilter	4	057228
HydroClean HydroClean	2	150309
engine oil filter Motoröfilter	8	085693
fuel filter Kraftstofffilter	8	105680
filter heater Filter Heizung	2	107202
filter heater, outside Filter Heizung (außen)	2	107060
filter water separator Filter Wasserabscheider	8	083176
air filter safety cartridge Sicherheitspatrone Luftfilter	2	068827

Description / Bezeichnung	Qty. / St.	No. / Nr.
air filter replacement cartridge Austauschpatrone Luftfilter	2	068826
V-belt alternator Keilriemen Lichtmaschine	1	076929
V-belt air conditioner Keilriemen Klimaanlage	1	125540
187030 inspection set (2000 h) / Inspektionssatz (2000 h) 875E (QXS 15 Tier 4i / IIIB)		
leakage oil filter Lecköfilter	4	027376
filter heater, outside Filter Heizung (außen)	2	107060
filter heater Filter Heizung	2	107202
water filter Kühlwasserfilter	1	135265
engine oil filter Motoröfilter	4	189624
auxiliary control filter Vorsteuerfilter	4	150308
HydroClean HydroClean	2	150309
return flow filter Rücklaufilter	4	151945
ventilation filter Belüftungsfilter	4	153955
pressure filter Druckfilter	4	154936
pressure filter Druckfilter	2	154938
filter replacement cartridge Filter Austauschpatrone	2	167973
filter safety cartridge Filter Sicherheitspatrone	2	167974
V-belt Keilriemen	2	170212
filter water separator Filter Wasserabscheider	4	176434
fuel filter Kraftstofffilter	1	189623
162787 inspection set (2000 h) / Inspektionssatz (2000 h) 608, 613D (TCD 12 Tier 3 / IIIA, VF, WA)		
return flow filter Rücklaufilter	2	150307
leakage oil filter Lecköfilter	2	027376
ventilation filter Belüftungsfilter	2	057228
auxiliary control filter Vorsteuerfilter	2	150308
pressure filter Druckfilter	2	205125
engine oil filter Motoröfilter	4	080543
fuel filter Kraftstofffilter	4	106109
filter water separator Filter Wasserabscheider	4	147645
filter air conditioner Filter Klimaanlage	2	138361
air filter safety cartridge Sicherheitspatrone Luftfilter	2	072385
air filter replacement cartridge Austauschpatrone Luftfilter	2	072386
V-belt alternator Keilriemen Lichtmaschine	1	108048
V-belt air conditioner Keilriemen Klimaanlage	1	059076
162788 inspection set (2000 h) / Inspektionssatz (2000 h) 608, 613D (TCD 12 Tier 3 / IIIA, VF, WAH)		
return flow filter Rücklaufilter	2	150307
leakage oil filter Lecköfilter	2	027376
ventilation filter Belüftungsfilter	2	057228
auxiliary control filter Vorsteuerfilter	2	150308

Description / Bezeichnung	Qty. / St.	No. / Nr.
pressure filter Druckfilter	2	205125
engine oil filter Motoröfilter	4	080543
fuel filter Kraftstofffilter	4	106109
filter water separator, heatable Filter Wasserabscheider, beheizbar	4	096151
filter air conditioner Filter Klimaanlage	2	138361
air filter safety cartridge Sicherheitspatrone Luftfilter	2	072385
air filter replacement cartridge Austauschpatrone Luftfilter	2	072386
V-belt alternator Keilriemen Lichtmaschine	1	108048
V-belt air conditioner Keilriemen Klimaanlage	1	059076
162789 inspection set (2000 h) / Inspektionssatz (2000 h) 608, 613D (TCD 12 Tier 3 / IIIA, HC, WA)		
return flow filter Rücklaufilter	2	150307
leakage oil filter Lecköfilter	2	027376
ventilation filter Belüftungsfilter	2	057228
HydroClean HydroClean	2	150309
pressure filter Druckfilter	2	205125
engine oil filter Motoröfilter	4	080543
fuel filter Kraftstofffilter	4	106109
filter water separator Filter Wasserabscheider	4	147645
filter air conditioner Filter Klimaanlage	2	138361
air filter safety cartridge Sicherheitspatrone Luftfilter	2	072385
air filter replacement cartridge Austauschpatrone Luftfilter	2	072386
V-belt alternator Keilriemen Lichtmaschine	1	108048
V-belt air conditioner Keilriemen Klimaanlage	1	059076
162790 inspection set (2000 h) / Inspektionssatz (2000 h) 608, 613D (TCD 12 Tier 3 / IIIA, HC, WAH)		
return flow filter Rücklaufilter	2	150307
leakage oil filter Lecköfilter	2	027376
ventilation filter Belüftungsfilter	2	057228
HydroClean HydroClean	2	150309
pressure filter Druckfilter	2	205125
engine oil filter Motoröfilter	4	080543
fuel filter Kraftstofffilter	4	106109
filter water separator, heatable Filter Wasserabscheider, beheizbar	4	096151
filter air conditioner Filter Klimaanlage	2	138361
air filter safety cartridge Sicherheitspatrone Luftfilter	2	072385
air filter replacement cartridge Austauschpatrone Luftfilter	2	072386
V-belt alternator Keilriemen Lichtmaschine	1	108048
V-belt air conditioner Keilriemen Klimaanlage	1	059076
238437 inspection set (2000 h) / Inspektionssatz (2000 h) 613E (FPT NEF 45 Tier 3 / IIIA, VF)		
return flow filter Rücklaufilter	2	150307

14.5 INSPECTION SETS (2000 H) / INSPEKTIONSSÄTZE (2000 H)

Description / Bezeichnung	Qty. / St.	No. / Nr.
leakage oil filter <i>Leckölfilter</i>	2	063580
ventilation filter <i>Belüftungsfilter</i>	2	153955
breather filter <i>Entlüftungsfilter</i>	2	168306
auxiliary control filter <i>Vorsteuerfilter</i>	2	150308
engine oil filter <i>Motorölfilter</i>	4	206076
fuel filter <i>Kraftstofffilter</i>	4	103142
filter water separator <i>Filter Wasserabscheider</i>	4	176434
filter air conditioner <i>Filter Klimaanlage</i>	2	138361
air filter safety cartridge <i>Sicherheitspatrone Luftfilter</i>	2	149255
air filter replacement cartridge <i>Austauschpatrone Luftfilter</i>	2	149256
V-belt <i>Keilriemen</i>	1	206172
V-belt <i>Keilriemen</i>	1	206782
238438 inspection set (2000 h) / Inspektionssatz (2000 h) 613E (FPT NEF 45 Tier 3 / IIIA, HC)		
return flow filter <i>Rücklauffilter</i>	2	150307
leakage oil filter <i>Leckölfilter</i>	2	063580
ventilation filter <i>Belüftungsfilter</i>	2	153955
breather filter <i>Entlüftungsfilter</i>	2	168306
HydroClean <i>HydroClean</i>	2	150309
engine oil filter <i>Motorölfilter</i>	4	206076
fuel filter <i>Kraftstofffilter</i>	4	103142
filter water separator <i>Filter Wasserabscheider</i>	4	176434
filter air conditioner <i>Filter Klimaanlage</i>	2	138361
air filter safety cartridge <i>Sicherheitspatrone Luftfilter</i>	2	149255
air filter replacement cartridge <i>Austauschpatrone Luftfilter</i>	2	149256
V-belt <i>Keilriemen</i>	1	206172
V-belt <i>Keilriemen</i>	1	206782
225371 inspection set (2000 h) / Inspektionssatz (2000 h) 613E (FPT NEF 45 Tier 4f / IV, VF)		
engine oil filter <i>Motorölfilter</i>	4	206076
fuel filter <i>Kraftstofffilter</i>	4	103142
fuel filter <i>Kraftstofffilter</i>	4	206184
filter crankcase ventilation <i>Filter Kurbelgehäuseentlüftung</i>	1	206075
V-belt <i>Keilriemen</i>	1	206172
V-belt <i>Keilriemen</i>	1	206782
seal <i>Ventildeckeldichtung</i>	1	206177
filter safety cartridge <i>Filter Sicherheitspatrone</i>	4	149255
filter replacement cartridge <i>Filter Austauschpatrone</i>	4	149256
auxiliary control filter <i>Vorsteuerfilter</i>	2	150308
return flow filter <i>Rücklauffilter</i>	4	150307
leakage oil filter <i>Leckölfilter</i>	2	027376
ventilation filter <i>Belüftungsfilter</i>	2	153955
breather filter <i>Entlüftungsfilter</i>	2	168306
auxiliary control filter <i>Vorsteuerfilter</i>	2	150308
engine oil filter <i>Motorölfilter</i>	4	106924
fuel filter <i>Kraftstofffilter</i>	4	103142
filter water separator <i>Filter Wasserabscheider</i>	4	176434
filter air conditioner <i>Filter Klimaanlage</i>	2	138361
air filter safety cartridge <i>Sicherheitspatrone Luftfilter</i>	2	064200
air filter replacement cartridge <i>Austauschpatrone Luftfilter</i>	2	118606
power belt <i>Kraftband</i>	1	116125
236486 inspection set (2000 h) / Inspektionssatz (2000 h) 633E (QSB 4.5 Tier 3 / IIIA, HC)		
return flow filter <i>Rücklauffilter</i>	2	150307
leakage oil filter <i>Leckölfilter</i>	2	063580
ventilation filter <i>Belüftungsfilter</i>	2	153955
breather filter <i>Entlüftungsfilter</i>	2	168306
return flow filter <i>Rücklauffilter</i>	2	150307
leakage oil filter <i>Leckölfilter</i>	2	027376
ventilation filter <i>Belüftungsfilter</i>	2	153955
breather filter <i>Entlüftungsfilter</i>	2	168306

Description / Bezeichnung	Qty. / St.	No. / Nr.
breather filter <i>Entlüftungsfilter</i>	2	168306
ventilation filter <i>Belüftungsfilter</i>	2	153955
filter heater <i>Filter Heizung</i>	2	107202
filter heater, outside <i>Filter Heizung (außen)</i>	2	107060
225378 inspection set (2000 h) / Inspektionssatz (2000 h) 613E (FPT NEF 45 Tier 4f / IV, HC)		
engine oil filter <i>Motorölfilter</i>	4	206076
fuel filter <i>Kraftstofffilter</i>	4	103142
fuel filter <i>Kraftstofffilter</i>	4	206184
filter crankcase ventilation <i>Filter Kurbelgehäuseentlüftung</i>	1	206075
V-belt <i>Keilriemen</i>	1	206172
V-belt <i>Keilriemen</i>	1	206782
seal <i>Ventildeckeldichtung</i>	1	206177
filter safety cartridge <i>Filter Sicherheitspatrone</i>	4	149255
filter replacement cartridge <i>Filter Austauschpatrone</i>	4	149256
auxiliary control filter <i>Vorsteuerfilter</i>	2	150308
return flow filter <i>Rücklauffilter</i>	4	150307
leakage oil filter <i>Leckölfilter</i>	2	027376
breather filter <i>Entlüftungsfilter</i>	2	168306
ventilation filter <i>Belüftungsfilter</i>	2	153955
filter heater <i>Filter Heizung</i>	2	107202
filter heater, outside <i>Filter Heizung (außen)</i>	2	107060
236485 inspection set (2000 h) / Inspektionssatz (2000 h) 633E (QSB 4.5 Tier 3 / IIIA, VF)		
return flow filter <i>Rücklauffilter</i>	2	150307
leakage oil filter <i>Leckölfilter</i>	2	063580
ventilation filter <i>Belüftungsfilter</i>	2	153955
breather filter <i>Entlüftungsfilter</i>	2	168306
auxiliary control filter <i>Vorsteuerfilter</i>	2	150308
engine oil filter <i>Motorölfilter</i>	4	106924
fuel filter <i>Kraftstofffilter</i>	4	103142
filter water separator <i>Filter Wasserabscheider</i>	4	176434
filter air conditioner <i>Filter Klimaanlage</i>	2	138361
air filter safety cartridge <i>Sicherheitspatrone Luftfilter</i>	2	064200
air filter replacement cartridge <i>Austauschpatrone Luftfilter</i>	2	118606
power belt <i>Kraftband</i>	1	116125
236486 inspection set (2000 h) / Inspektionssatz (2000 h) 633E (QSB 4.5 Tier 3 / IIIA, HC)		
return flow filter <i>Rücklauffilter</i>	2	150307
leakage oil filter <i>Leckölfilter</i>	2	063580
ventilation filter <i>Belüftungsfilter</i>	2	153955
breather filter <i>Entlüftungsfilter</i>	2	168306

Description / Bezeichnung	Qty. / St.	No. / Nr.
HydroClean <i>HydroClean</i>	2	150309
engine oil filter <i>Motorölfilter</i>	4	106924
fuel filter <i>Kraftstofffilter</i>	4	103142
filter water separator <i>Filter Wasserabscheider</i>	4	176434
filter air conditioner <i>Filter Klimaanlage</i>	2	138361
air filter safety cartridge <i>Sicherheitspatrone Luftfilter</i>	2	064200
air filter replacement cartridge <i>Austauschpatrone Luftfilter</i>	2	118606
power belt <i>Kraftband</i>	1	116125
162796 inspection set (2000 h) / Inspektionssatz (2000 h) 643 (TCD 12 Tier 3 / IIIA, VF, WA)		
return flow filter <i>Rücklauffilter</i>	2	150307
leakage oil filter <i>Leckölfilter</i>	2	027376
ventilation filter <i>Belüftungsfilter</i>	2	057228
auxiliary control filter <i>Vorsteuerfilter</i>	2	150308
engine oil filter <i>Motorölfilter</i>	4	027026
fuel filter <i>Kraftstofffilter</i>	8	084776
filter water separator <i>Filter Wasserabscheider</i>	4	147645
filter heater <i>Filter Heizung</i>	2	107202
filter heater, outside <i>Filter Heizung (außen)</i>	2	107060
air filter safety cartridge <i>Sicherheitspatrone Luftfilter</i>	2	100719
air filter replacement cartridge <i>Austauschpatrone Luftfilter</i>	2	100720
V-belt alternator <i>Keilriemen Lichtmaschine</i>	1	082454
V-belt water pump <i>Keilriemen Wasserpumpe</i>	1	080542
V-belt air conditioner <i>Keilriemen Klimaanlage</i>	1	084264
162797 inspection set (2000 h) / Inspektionssatz (2000 h) 643 (TCD 12 Tier 3 / IIIA, VF, WAH)		
return flow filter <i>Rücklauffilter</i>	2	150307
leakage oil filter <i>Leckölfilter</i>	2	027376
ventilation filter <i>Belüftungsfilter</i>	2	057228
auxiliary control filter <i>Vorsteuerfilter</i>	2	150308
engine oil filter <i>Motorölfilter</i>	4	027026
fuel filter <i>Kraftstofffilter</i>	8	084776
filter water separator, heatable <i>Filter Wasserabscheider, beheizbar</i>	4	096151
filter heater <i>Filter Heizung</i>	2	107202
filter heater, outside <i>Filter Heizung (außen)</i>	2	107060
air filter safety cartridge <i>Sicherheitspatrone Luftfilter</i>	2	100719
air filter replacement cartridge <i>Austauschpatrone Luftfilter</i>	2	100720
V-belt alternator <i>Keilriemen Lichtmaschine</i>	1	082454
V-belt water pump <i>Keilriemen Wasserpumpe</i>	1	080542
V-belt air conditioner <i>Keilriemen Klimaanlage</i>	1	084264

14.5 INSPECTION SETS (2000 H) / INSPEKTIONSSÄTZE (2000 H)

Description / Bezeichnung	Qty. / St.	No. / Nr.
162798 inspection set (2000 h) / Inspektionssatz (2000 h) 643 (TCD 12 Tier 3 / IIIA, HC, WA)		
return flow filter Rücklauffilter	2	150307
leakage oil filter Leckölfilter	2	027376
ventilation filter Belüftungsfilter	2	057228
HydroClean HydroClean	2	150309
engine oil filter Motorölfilter	4	027026
fuel filter Kraftstofffilter	8	084776
filter water separator Filter Wasserabscheider	4	147645
filter heater Filter Heizung	2	107202
filter heater, outside Filter Heizung (außen)	2	107060
air filter safety cartridge Sicherheitspatrone Luftfilter	2	100719
air filter replacement cartridge Austauschpatrone Luftfilter	2	100720
V-belt alternator Keilriemen Lichtmaschine	1	082454
V-belt water pump Keilriemen Wasserpumpe	1	080542
V-belt air conditioner Keilriemen Klimaanlage	1	084264
162799 inspection set (2000 h) / Inspektionssatz (2000 h) 643 (TCD 12 Tier 3 / IIIA, HC, WAH)		
return flow filter Rücklauffilter	2	150307
leakage oil filter Leckölfilter	2	027376
ventilation filter Belüftungsfilter	2	057228
HydroClean HydroClean	2	150309
engine oil filter Motorölfilter	4	027026
fuel filter Kraftstofffilter	8	084776
filter water separator, heatable Filter Wasserabscheider, beheizbar	4	096151
filter heater Filter Heizung	2	107202
filter heater, outside Filter Heizung (außen)	2	107060
air filter safety cartridge Sicherheitspatrone Luftfilter	2	100719
air filter replacement cartridge Austauschpatrone Luftfilter	2	100720
V-belt alternator Keilriemen Lichtmaschine	1	082454
V-belt water pump Keilriemen Wasserpumpe	1	080542
V-belt air conditioner Keilriemen Klimaanlage	1	084264
238552 inspection set (2000 h) / Inspektionssatz (2000 h) 643E (QSB 4.5 Tier 3 / IIIA, VF)		
return flow filter Rücklauffilter	2	150307
leakage oil filter Leckölfilter	2	063580
ventilation filter Belüftungsfilter	2	153955
breather filter Entlüftungsfilter	2	168306
auxiliary control filter Vorsteuerfilter	2	150308
engine oil filter Motorölfilter	4	106924
fuel filter Kraftstofffilter	4	169951
filter water separator Filter Wasserabscheider	4	176434
filter air conditioner Filter Klimaanlage	2	138361
air filter safety cartridge Sicherheitspatrone Luftfilter	2	167974
air filter replacement cartridge Austauschpatrone Luftfilter	2	187692
power belt Kraftband	1	172327
238562 inspection set (2000 h) / Inspektionssatz (2000 h) 643E (QSB 4.5 Tier 4f / IV, HC)		
return flow filter Rücklauffilter	2	150307
leakage oil filter Leckölfilter	2	063580
ventilation filter Belüftungsfilter	2	153955
breather filter Entlüftungsfilter	2	168306

Description / Bezeichnung	Qty. / St.	No. / Nr.
fuel filter Kraftstofffilter	4	103142
filter water separator Filter Wasserabscheider	4	176434
filter air conditioner Filter Klimaanlage	2	138361
air filter safety cartridge Sicherheitspatrone Luftfilter	2	064200
air filter replacement cartridge Austauschpatrone Luftfilter	2	118606
power belt Kraftband	1	116125
238553 inspection set (2000 h) / Inspektionssatz (2000 h) 643E (QSB 4.5 Tier 3 / IIIA, HC)		
return flow filter Rücklauffilter	2	150307
leakage oil filter Leckölfilter	2	063580
ventilation filter Belüftungsfilter	2	153955
breather filter Entlüftungsfilter	2	168306
HydroClean HydroClean	2	150309
engine oil filter Motorölfilter	4	106924
fuel filter Kraftstofffilter	4	103142
filter water separator Filter Wasserabscheider	4	176434
filter air conditioner Filter Klimaanlage	2	138361
air filter safety cartridge Sicherheitspatrone Luftfilter	2	064200
air filter replacement cartridge Austauschpatrone Luftfilter	2	118606
power belt Kraftband	1	116125
238561 inspection set (2000 h) / Inspektionssatz (2000 h) 643E (QSB 4.5 Tier 4f / IV, VF)		
return flow filter Rücklauffilter	2	150307
leakage oil filter Leckölfilter	2	063580
ventilation filter Belüftungsfilter	2	153955
breather filter Entlüftungsfilter	2	168306
auxiliary control filter Vorsteuerfilter	2	150308
engine oil filter Motorölfilter	4	106924
fuel filter Kraftstofffilter	4	169951
filter water separator Filter Wasserabscheider	4	176434
filter air conditioner Filter Klimaanlage	2	138361
air filter safety cartridge Sicherheitspatrone Luftfilter	2	167974
air filter replacement cartridge Austauschpatrone Luftfilter	2	187692
power belt Kraftband	1	172327
238562 inspection set (2000 h) / Inspektionssatz (2000 h) 643E (QSB 4.5 Tier 4f / IV, HC)		
return flow filter Rücklauffilter	2	150307
leakage oil filter Leckölfilter	2	063580
ventilation filter Belüftungsfilter	2	153955
breather filter Entlüftungsfilter	2	168306

Description / Bezeichnung	Qty. / St.	No. / Nr.
HydroClean HydroClean	2	150309
engine oil filter Motorölfilter	4	106924
fuel filter Kraftstofffilter	4	169951
filter water separator Filter Wasserabscheider	4	176434
filter air conditioner Filter Klimaanlage	2	138361
air filter safety cartridge Sicherheitspatrone Luftfilter	2	167974
air filter replacement cartridge Austauschpatrone Luftfilter	2	187692
power belt Kraftband	1	172327
236501 inspection set (2000 h) / Inspektionssatz (2000 h) 653E (QSB 4.5 Tier 3 / IIIA, VF)		
return flow filter Rücklauffilter	4	150307
leakage oil filter Leckölfilter	2	027376
ventilation filter Belüftungsfilter	2	153955
breather filter Entlüftungsfilter	2	168306
auxiliary control filter Vorsteuerfilter	2	150308
engine oil filter Motorölfilter	4	106924
fuel filter Kraftstofffilter	4	103142
filter water separator Filter Wasserabscheider	4	176434
filter heater, inside Filter Heizung, innen	2	107202
filter heater, outside Filter Heizung, außen	2	107060
air filter safety cartridge Sicherheitspatrone Luftfilter	2	064200
air filter replacement cartridge Austauschpatrone Luftfilter	2	118606
power belt Kraftband	1	172327
236502 inspection set (2000 h) / Inspektionssatz (2000 h) 653E (QSB 4.5 Tier 3 / IIIA, HC)		
return flow filter Rücklauffilter	4	150307
leakage oil filter Leckölfilter	2	027376
ventilation filter Belüftungsfilter	2	153955
breather filter Entlüftungsfilter	2	168306
HydroClean HydroClean	2	150309
engine oil filter Motorölfilter	4	106924
fuel filter Kraftstofffilter	4	103142
filter water separator Filter Wasserabscheider	4	176434
filter heater, inside Filter Heizung, innen	2	107202
filter heater, outside Filter Heizung, außen	2	107060
air filter safety cartridge Sicherheitspatrone Luftfilter	2	064200
air filter replacement cartridge Austauschpatrone Luftfilter	2	118606
power belt Kraftband	1	172327

14.5 INSPECTION SETS (2000 H) / INSPEKTIONSSÄTZE (2000 H)

Description / Bezeichnung	Qty. / St.	No. / Nr.
232251 inspection set (2000 h) / Inspektionssatz (2000 h) 653E (QSB 4.5 Tier 4f / IV, VF)		
engine oil filter <i>Motorölfilter</i>	4	106924
fuel filter <i>Kraftstofffilter</i>	4	176434
fuel filter <i>Kraftstofffilter</i>	4	169951
V-belt <i>Keilriemen</i>	1	172327
filter safety cartridge <i>Filter Sicherheitspatrone</i>	2	167974
filter replacement cartridge <i>Filter Austauschpatrone</i>	2	187692
auxiliary control filter <i>Vorsteuerfilter</i>	2	150308
return flow filter <i>Rücklauffilter</i>	2	150307
leakage oil filter <i>Leckölfilter</i>	2	027376
ventilation filter <i>Belüftungsfilter</i>	2	153955
filter heater <i>Filter Heizung</i>	2	107202
filter heater, outside <i>Filter Heizung (außen)</i>	2	107060
breather filter <i>Entlüftungsfilter</i>	1	168306
222347 inspection set (2000 h) / Inspektionssatz (2000 h) 653E (QSB 4.5 Tier 4f / IV, HC)		
engine oil filter <i>Motorölfilter</i>	4	106924
fuel filter <i>Kraftstofffilter</i>	4	176434
fuel filter <i>Kraftstofffilter</i>	4	169951
V-belt <i>Keilriemen</i>	1	172327
filter safety cartridge <i>Filter Sicherheitspatrone</i>	2	167974
filter replacement cartridge <i>Filter Austauschpatrone</i>	2	187692
HydroClean <i>HydroClean</i>	2	150309
return flow filter <i>Rücklauffilter</i>	2	150307
leakage oil filter <i>Leckölfilter</i>	2	027376
ventilation filter <i>Belüftungsfilter</i>	2	153955
filter heater <i>Filter Heizung</i>	2	107202
filter heater, outside <i>Filter Heizung (außen)</i>	2	107060
breather filter <i>Entlüftungsfilter</i>	1	168306
236493 inspection set (2000 h) / Inspektionssatz (2000 h) 673E (QSB 6.7 Tier 3 / IIIA, VF)		
return flow filter <i>Rücklauffilter</i>	4	150307
leakage oil filter <i>Leckölfilter</i>	2	027376
ventilation filter <i>Belüftungsfilter</i>	2	153955
auxiliary control filter <i>Vorsteuerfilter</i>	2	150308
engine oil filter <i>Motorölfilter</i>	4	106924
fuel filter <i>Kraftstofffilter</i>	4	103142
filter water separator <i>Filter Wasserabscheider</i>	4	176434
filter heater, inside <i>Filter Heizung, innen</i>	2	107202
filter heater, outside <i>Filter Heizung, außen</i>	2	107060
air filter safety cartridge <i>Sicherheitspatrone Luftfilter</i>	2	167974
air filter replacement cartridge <i>Austauschpatrone Luftfilter</i>	2	167973
V-belt alternator <i>Keilriemen Lichtmaschine</i>	1	189663
V-belt <i>Keilriemen</i>	1	053292
232254 inspection set (2000 h) / Inspektionssatz (2000 h) 673E (QSB 6.7 Tier 4f / IV, VF)		
engine oil filter <i>Motorölfilter</i>	4	106924
fuel filter <i>Kraftstofffilter</i>	4	176434
fuel filter <i>Kraftstofffilter</i>	4	169951
filter crankcase ventilation <i>Filter Kurbelgehäuseentlüftung</i>	1	169482
V-belt <i>Keilriemen</i>	1	169976
V-belt air conditioner <i>Keilriemen Klimaanlage</i>	1	059077
filter safety cartridge <i>Filter Sicherheitspatrone</i>	2	167974
filter replacement cartridge <i>Filter Austauschpatrone</i>	2	167973
auxiliary control filter <i>Vorsteuerfilter</i>	2	150308
return flow filter <i>Rücklauffilter</i>	4	150307
leakage oil filter <i>Leckölfilter</i>	2	027376
ventilation filter <i>Belüftungsfilter</i>	2	174541
filter heater <i>Filter Heizung</i>	2	107202
filter heater, outside <i>Filter Heizung (außen)</i>	2	107060
186440 inspection set (2000 h) / Inspektionssatz (2000 h) 673E (QSB 6.7 Tier 4f / IV, HC)		
engine oil filter <i>Motorölfilter</i>	4	106924
filter water separator <i>Filter Wasserabscheider</i>	4	176434
fuel filter <i>Kraftstofffilter</i>	4	169951
filter crankcase ventilation <i>Filter Kurbelgehäuseentlüftung</i>	1	169482
V-belt <i>Keilriemen</i>	1	167976
V-belt air conditioner <i>Keilriemen Klimaanlage</i>	1	059077

Description / Bezeichnung	Qty. / St.	No. / Nr.
air filter replacement cartridge <i>Austauschpatrone Luftfilter</i>	2	167973
V-belt alternator <i>Keilriemen Lichtmaschine</i>	1	189663
V-belt <i>Keilriemen</i>	1	053292
236494 inspection set (2000 h) / Inspektionssatz (2000 h) 673E (QSB 6.7 Tier 3 / IIIA, HC)		
return flow filter <i>Rücklauffilter</i>	4	150307
leakage oil filter <i>Leckölfilter</i>	2	027376
ventilation filter <i>Belüftungsfilter</i>	2	153955
HydroClean <i>HydroClean</i>	2	150309
engine oil filter <i>Motorölfilter</i>	4	106924
fuel filter <i>Kraftstofffilter</i>	4	103142
filter water separator <i>Filter Wasserabscheider</i>	4	176434
filter heater, inside <i>Filter Heizung, innen</i>	2	107202
filter heater, outside <i>Filter Heizung, außen</i>	2	107060
air filter safety cartridge <i>Sicherheitspatrone Luftfilter</i>	2	167974
air filter replacement cartridge <i>Austauschpatrone Luftfilter</i>	2	167973
V-belt alternator <i>Keilriemen Lichtmaschine</i>	1	189663
V-belt <i>Keilriemen</i>	1	053292
232254 inspection set (2000 h) / Inspektionssatz (2000 h) 673E (QSB 6.7 Tier 4f / IV, VF)		
engine oil filter <i>Motorölfilter</i>	4	106924
fuel filter <i>Kraftstofffilter</i>	4	176434
fuel filter <i>Kraftstofffilter</i>	4	169951
filter crankcase ventilation <i>Filter Kurbelgehäuseentlüftung</i>	1	169482
V-belt <i>Keilriemen</i>	1	169976
V-belt air conditioner <i>Keilriemen Klimaanlage</i>	1	059077
filter safety cartridge <i>Filter Sicherheitspatrone</i>	2	167974
filter replacement cartridge <i>Filter Austauschpatrone</i>	2	167973
auxiliary control filter <i>Vorsteuerfilter</i>	2	150308
return flow filter <i>Rücklauffilter</i>	4	150307
leakage oil filter <i>Leckölfilter</i>	2	027376
ventilation filter <i>Belüftungsfilter</i>	2	174541
filter heater <i>Filter Heizung</i>	2	107202
filter heater, outside <i>Filter Heizung (außen)</i>	2	107060
186440 inspection set (2000 h) / Inspektionssatz (2000 h) 673E (QSB 6.7 Tier 4f / IV, HC)		
engine oil filter <i>Motorölfilter</i>	4	106924
filter water separator <i>Filter Wasserabscheider</i>	4	176434
fuel filter <i>Kraftstofffilter</i>	4	169951
filter crankcase ventilation <i>Filter Kurbelgehäuseentlüftung</i>	1	169482
V-belt <i>Keilriemen</i>	1	167976
V-belt air conditioner <i>Keilriemen Klimaanlage</i>	1	059077

Description / Bezeichnung	Qty. / St.	No. / Nr.
filter safety cartridge <i>Filter Sicherheitspatrone</i>	2	167974
filter replacement cartridge <i>Filter Austauschpatrone</i>	2	167973
HydroClean <i>HydroClean</i>	2	150309
return flow filter <i>Rücklauffilter</i>	4	150307
leakage oil filter <i>Leckölfilter</i>	2	027376
ventilation filter <i>Belüftungsfilter</i>	2	174541
filter heater <i>Filter Heizung</i>	2	107202
filter heater, outside <i>Filter Heizung (außen)</i>	2	107060
162800 inspection set (2000 h) / Inspektionssatz (2000 h) 683 (TCD 13 Tier 3 / IIIA, VF, WA)		
return flow filter <i>Rücklauffilter</i>	4	150307
leakage oil filter <i>Leckölfilter</i>	2	027376
ventilation filter <i>Belüftungsfilter</i>	2	057228
auxiliary control filter <i>Vorsteuerfilter</i>	2	150308
engine oil filter <i>Motorölfilter</i>	4	027026
fuel filter <i>Kraftstofffilter</i>	8	084776
filter water separator <i>Filter Wasserabscheider</i>	4	147645
filter heater <i>Filter Heizung</i>	2	107202
filter heater, outside <i>Filter Heizung (außen)</i>	2	107060
air filter safety cartridge <i>Sicherheitspatrone Luftfilter</i>	2	064200
air filter replacement cartridge <i>Austauschpatrone Luftfilter</i>	2	118606
V-belt alternator <i>Keilriemen Lichtmaschine</i>	1	082454
V-belt water pump <i>Keilriemen Wasserpumpe</i>	1	030288
V-belt air conditioner <i>Keilriemen Klimaanlage</i>	1	059077
162801 inspection set (2000 h) / Inspektionssatz (2000 h) 683 (TCD 13 Tier 3 / IIIA, VF, WAH)		
return flow filter <i>Rücklauffilter</i>	4	150307
leakage oil filter <i>Leckölfilter</i>	2	027376
ventilation filter <i>Belüftungsfilter</i>	2	057228
auxiliary control filter <i>Vorsteuerfilter</i>	2	150308
engine oil filter <i>Motorölfilter</i>	4	027026
fuel filter <i>Kraftstofffilter</i>	8	084776
filter water separator, heatable <i>Filter Wasserabscheider, beheizbar</i>	4	096151
filter heater <i>Filter Heizung</i>	2	107202
filter heater, outside <i>Filter Heizung (außen)</i>	2	107060
air filter safety cartridge <i>Sicherheitspatrone Luftfilter</i>	2	064200
air filter replacement cartridge <i>Austauschpatrone Luftfilter</i>	2	118606
V-belt alternator <i>Keilriemen Lichtmaschine</i>	1	082454
V-belt water pump <i>Keilriemen Wasserpumpe</i>	1	030288
V-belt air conditioner <i>Keilriemen Klimaanlage</i>	1	059077

14.5 INSPECTION SETS (2000 H) / INSPEKTIONSSÄTZE (2000 H)

Description / Bezeichnung	Qty. / St.	No. / Nr.
162802 inspection set (2000 h) / Inspektionssatz (2000 h) 683 (TCD 13 Tier 3 / IIIA, HC, WA)		
return flow filter Rücklaufilter	4	150307
leakage oil filter Leckölfilter	2	027376
ventilation filter Belüftungsfilter	2	057228
HydroClean HydroClean	2	150309
engine oil filter Motorölfilter	4	027026
fuel filter Kraftstofffilter	8	084776
filter water separator Filter Wasserabscheider	4	147645
filter heater Filter Heizung	2	107202
filter heater, outside Filter Heizung (außen)	2	107060
air filter safety cartridge Sicherheitspatrone Luftfilter	2	064200
air filter replacement cartridge Austauschpatrone Luftfilter	2	118606
V-belt alternator Keilriemen Lichtmaschine	1	082454
V-belt water pump Keilriemen Wasserpumpe	1	030288
V-belt air conditioner Keilriemen Klimaanlage	1	059077
162803 inspection set (2000 h) / Inspektionssatz (2000 h) 683 (TCD 13 Tier 3 / IIIA, HC, WAH)		
return flow filter Rücklaufilter	4	150307
leakage oil filter Leckölfilter	2	027376
ventilation filter Belüftungsfilter	2	057228
HydroClean HydroClean	2	150309
engine oil filter Motorölfilter	4	027026
fuel filter Kraftstofffilter	8	084776
filter water separator, heatable Filter Wasserabscheider, beheizbar	4	096151
filter heater Filter Heizung	2	107202
filter heater, outside Filter Heizung (außen)	2	107060
air filter safety cartridge Sicherheitspatrone Luftfilter	2	064200
air filter replacement cartridge Austauschpatrone Luftfilter	2	118606
V-belt alternator Keilriemen Lichtmaschine	1	082454
V-belt water pump Keilriemen Wasserpumpe	1	030288
V-belt air conditioner Keilriemen Klimaanlage	1	059077
242402 inspection set (2000 h) / Inspektionssatz (2000 h) 6113E (QSB 6.7 Tier 3 / IIIA, VF)		
return flow filter Rücklaufilter	4	150307
leakage oil filter Leckölfilter	2	027376
ventilation filter Belüftungsfilter	2	153955
breather filter Entlüftungsfilter	2	168306
auxiliary control filter Vorsteuerfilter	2	150308
engine oil filter Motorölfilter	4	106924
fuel filter Kraftstofffilter	4	169951
filter water separator Filter Wasserabscheider	4	176434
filter crankcase ventilation Filter Kurbelgehäuseentlüftung	1	169482
filter heater, inside Filter Heizung, innen	2	107202
filter heater, outside Filter Heizung, außen	2	107060

Description / Bezeichnung	Qty. / St.	No. / Nr.
fuel filter Kraftstofffilter	4	103142
filter water separator Filter Wasserabscheider	4	176434
filter crankcase ventilation Filter Kurbelgehäuseentlüftung	1	169482
filter heater, inside Filter Heizung, innen	2	107202
filter heater, outside Filter Heizung, außen	2	107060
air filter safety cartridge Sicherheitspatrone Luftfilter	2	167974
air filter replacement cartridge Austauschpatrone Luftfilter	2	167973
V-belt alternator Keilriemen Lichtmaschine	1	189663
V-belt Keilriemen	1	053292
242403 inspection set (2000 h) / Inspektionssatz (2000 h) 6113E (QSB 6.7 Tier 3 / IIIA, HC)		
return flow filter Rücklaufilter	4	150307
leakage oil filter Leckölfilter	2	027376
ventilation filter Belüftungsfilter	2	153955
breather filter Entlüftungsfilter	2	168306
HydroClean HydroClean	2	150309
engine oil filter Motorölfilter	4	106924
fuel filter Kraftstofffilter	4	103142
filter water separator Filter Wasserabscheider	4	176434
filter crankcase ventilation Filter Kurbelgehäuseentlüftung	1	169482
filter heater, inside Filter Heizung, innen	2	107202
filter heater, outside Filter Heizung, außen	2	107060
air filter safety cartridge Sicherheitspatrone Luftfilter	2	167974
air filter replacement cartridge Austauschpatrone Luftfilter	2	167973
V-belt alternator Keilriemen Lichtmaschine	1	189663
V-belt Keilriemen	1	053292
242539 inspection set (2000 h) / Inspektionssatz (2000 h) 6113E (QSB 6.7 Tier 4f / IV, VF)		
return flow filter Rücklaufilter	4	150307
leakage oil filter Leckölfilter	2	027376
ventilation filter Belüftungsfilter	2	153955
breather filter Entlüftungsfilter	2	168306
auxiliary control filter Vorsteuerfilter	2	150308
engine oil filter Motorölfilter	4	106924
fuel filter Kraftstofffilter	4	169951
filter water separator Filter Wasserabscheider	4	176434
filter crankcase ventilation Filter Kurbelgehäuseentlüftung	1	169482
filter heater, inside Filter Heizung, innen	2	107202
filter heater, outside Filter Heizung, außen	2	107060

Description / Bezeichnung	Qty. / St.	No. / Nr.
air filter safety cartridge Sicherheitspatrone Luftfilter	4	167974
air filter replacement cartridge Austauschpatrone Luftfilter	4	167973
V-belt Keilriemen	1	167976
V-belt Keilriemen	1	161492
242527 inspection set (2000 h) / Inspektionssatz (2000 h) 6113E (QSB 6.7 Tier 4f / IV, HC)		
return flow filter Rücklaufilter	4	150307
leakage oil filter Leckölfilter	2	027376
ventilation filter Belüftungsfilter	2	153955
breather filter Entlüftungsfilter	2	168306
HydroClean HydroClean	2	150309
engine oil filter Motorölfilter	4	106924
fuel filter Kraftstofffilter	4	169951
filter water separator Filter Wasserabscheider	4	176434
filter crankcase ventilation Filter Kurbelgehäuseentlüftung	1	169482
filter heater, inside Filter Heizung, innen	2	107202
filter heater, outside Filter Heizung, außen	2	107060
air filter safety cartridge Sicherheitspatrone Luftfilter	4	167974
air filter replacement cartridge Austauschpatrone Luftfilter	4	167973
V-belt Keilriemen	1	167976
V-belt Keilriemen	1	161492
162792 inspection set (2000 h) / Inspektionssatz (2000 h) 630D (TCD 13 Tier 3 / IIIA, VF)		
return flow filter Rücklaufilter	4	150307
leakage oil filter Leckölfilter	2	027376
ventilation filter Belüftungsfilter	2	057228
auxiliary control filter Vorsteuerfilter	4	150308
pressure filter Druckfilter	2	205125
engine oil filter Motorölfilter	4	027026
fuel filter Kraftstofffilter	8	084776
filter water separator Filter Wasserabscheider	4	147645
filter heater Filter Heizung	2	107202
filter heater, outside Filter Heizung (außen)	2	107060
air filter safety cartridge Sicherheitspatrone Luftfilter	2	064200
air filter replacement cartridge Austauschpatrone Luftfilter	2	118606
V-belt alternator Keilriemen Lichtmaschine	1	082454
V-belt water pump Keilriemen Wasserpumpe	1	109242
V-belt air conditioner Keilriemen Klimaanlage	1	059077

14.5 INSPECTION SETS (2000 H) / INSPEKTIONSSÄTZE (2000 H)

Description / Bezeichnung	Qty. / St.	No. / Nr.
162794 inspection set (2000 h) / Inspektionssatz (2000 h) 630D (TCD 13 Tier 3 / IIIA, HC)		
return flow filter Rücklauffilter	4	150307
leakage oil filter Leckölfilter	2	027376
ventilation filter Belüftungsfilter	2	057228
HydroClean HydroClean	2	150309
auxiliary control filter Vorsteuerfilter	2	150308
pressure filter Druckfilter	2	205125
engine oil filter Motorölfilter	4	027026
fuel filter Kraftstofffilter	8	084776
filter water separator Filter Wasserabscheider	4	147645
filter heater Filter Heizung	2	107202
filter heater, outside Filter Heizung (außen)	2	107060
air filter safety cartridge Sicherheitspatrone Luftfilter	2	064200
air filter replacement cartridge Austauschpatrone Luftfilter	2	118606
V-belt alternator Keilriemen Lichtmaschine	1	082454
V-belt water pump Keilriemen Wasserpumpe	1	109242
V-belt air conditioner Keilriemen Klimaanlage	1	059077
217282 inspection set (2000 h) / Inspektionssatz (2000 h) 640E (CAT C7.1 Tier 3 / IIIA)		
engine oil filter Motorölfilter	4	177580
fuel filter Kraftstofffilter	8	177606
filter water separator Filter Wasserabscheider	4	064893
air filter safety cartridge Sicherheitspatrone Luftfilter	1	149255
air filter replacement cartridge Austauschpatrone Luftfilter	1	149256
filter heater Filter Heizung	2	107202
filter heater, outside Filter Heizung (außen)	2	107060
return flow filter Rücklauffilter	2	151945
leakage oil filter Leckölfilter	4	027376
ventilation filter Belüftungsfilter	2	153955
HydroClean HydroClean	2	150309
auxiliary control filter Vorsteuerfilter	4	150308
line filter Speisedruckfilter	4	154947
217286 inspection set (2000 h) / Inspektionssatz (2000 h) 640E (CAT C7.1 Tier 4f / IV)		
engine oil filter Motorölfilter	4	177580
fuel filter Kraftstofffilter	8	177606
filter water separator Filter Wasserabscheider	4	171162
air filter safety cartridge Sicherheitspatrone Luftfilter	1	149255

Description / Bezeichnung	Qty. / St.	No. / Nr.
air filter replacement cartridge Austauschpatrone Luftfilter	1	149256
filter heater Filter Heizung	2	107202
filter heater, outside Filter Heizung (außen)	2	107060
return flow filter Rücklauffilter	2	151945
leakage oil filter Leckölfilter	4	027376
ventilation filter Belüftungsfilter	1	153955
HydroClean HydroClean	2	150309
auxiliary control filter Vorsteuerfilter	4	150308
line filter Speisedruckfilter	4	154947
236466 inspection set (2000 h) / Inspektionssatz (2000 h) 1100E (QSB 6.7 Tier 4f / IV, VF)		
engine oil filter Motorölfilter	4	106924
fuel filter Kraftstofffilter	4	169951
filter water separator Filter Wasserabscheider	4	176434
V-belt Keilriemen	1	167976
V-belt Keilriemen	1	161492
air filter safety cartridge Sicherheitspatrone Luftfilter	2	167974
air filter replacement cartridge Austauschpatrone Luftfilter	2	167973
auxiliary control filter Vorsteuerfilter	2	150308
return flow filter Rücklauffilter	2	151945
leakage oil filter Leckölfilter	2	027376
breather filter Entlüftungsfilter	2	168306
ventilation filter Belüftungsfilter	3	153955
filter heater, inside Filter Heizung, innen	2	107202
filter heater, outside Filter Heizung, außen	2	107060
236469 inspection set (2000 h) / Inspektionssatz (2000 h) 1100E (QSB 6.7 Tier 4f / IV, HC)		
engine oil filter Motorölfilter	4	106924
fuel filter Kraftstofffilter	4	169951
filter water separator Filter Wasserabscheider	4	176434
V-belt Keilriemen	1	167976
V-belt Keilriemen	1	161492
air filter safety cartridge Sicherheitspatrone Luftfilter	2	167974
air filter replacement cartridge Austauschpatrone Luftfilter	2	167973
HydroClean HydroClean	2	150309
return flow filter Rücklauffilter	2	151945
leakage oil filter Leckölfilter	2	027376
breather filter Entlüftungsfilter	2	168306

Description / Bezeichnung	Qty. / St.	No. / Nr.
ventilation filter Belüftungsfilter	3	153955
filter heater, inside Filter Heizung, innen	2	107202
filter heater, outside Filter Heizung, außen	2	107060
162808 inspection set (2000 h) / Inspektionssatz (2000 h) 2200 (Cat C7 Tier 3 / IIIA, VF)		
return flow filter Rücklauffilter	8	150307
leakage oil filter Leckölfilter	4	027376
ventilation filter Belüftungsfilter	2	057228
auxiliary control filter Vorsteuerfilter	2	150308
engine oil filter Motorölfilter	8	080749
fuel filter Kraftstofffilter	8	043277
filter water separator Filter Wasserabscheider	8	083176
filter heater Filter Heizung	2	107202
filter heater, outside Filter Heizung (außen)	2	107060
air filter safety cartridge Sicherheitspatrone Luftfilter	2	064200
air filter replacement cartridge Austauschpatrone Luftfilter	2	118606
V-belt alternator Keilriemen Lichtmaschine	1	072533
V-belt water pump Keilriemen Wasserpumpe	1	099128
V-belt air conditioner Keilriemen Klimaanlage	1	084264
162809 inspection set (2000 h) / Inspektionssatz (2000 h) 2200 (Cat C7 Tier 3 / IIIA, HC)		
return flow filter Rücklauffilter	8	150307
leakage oil filter Leckölfilter	4	027376
ventilation filter Belüftungsfilter	2	057228
auxiliary control filter Vorsteuerfilter	2	150308
engine oil filter Motorölfilter	8	080749
fuel filter Kraftstofffilter	8	043277
filter water separator Filter Wasserabscheider	8	083176
filter heater Filter Heizung	2	107202
filter heater, outside Filter Heizung (außen)	2	107060
air filter safety cartridge Sicherheitspatrone Luftfilter	2	064200
air filter replacement cartridge Austauschpatrone Luftfilter	2	118606
V-belt alternator Keilriemen Lichtmaschine	1	072533
V-belt water pump Keilriemen Wasserpumpe	1	099128
V-belt air conditioner Keilriemen Klimaanlage	1	084264

14.5 INSPECTION SETS (2000 H) / INSPEKTIONSSÄTZE (2000 H)

Description / Bezeichnung	Qty. / St.	No. / Nr.
162811 inspection set (2000 h) / Inspektionssatz (2000 h) 2200E (Cat C7 Tier 3 / IIIA, VF)		
return flow filter Rücklauffilter	2	151945
leakage oil filter Leckölfilter	4	027376
ventilation filter Belüftungsfilter	2	174541
auxiliary control filter Vorsteuerfilter	2	150308
engine oil filter Motorölfilter	8	080749
fuel filter Kraftstofffilter	8	043277
filter water separator Filter Wasserabscheider	8	083176
filter heater Filter Heizung	2	107202
filter heater, outside Filter Heizung (außen)	2	107060
air filter safety cartridge Sicherheitspatrone Luftfilter	2	149255
air filter replacement cartridge Austauschpatrone Luftfilter	2	149256
V-belt alternator Keilriemen Lichtmaschine	2	072533
V-belt water pump Keilriemen Wasserpumpe	2	099128
V-belt air conditioner Keilriemen Klimaanlage	2	084264
162812 inspection set (2000 h) / Inspektionssatz (2000 h) 2200E (Cat C7 Tier 3 / IIIA, HC)		
return flow filter Rücklauffilter	2	151945
leakage oil filter Leckölfilter	4	027376
ventilation filter Belüftungsfilter	2	174541
HydroClean HydroClean	2	150309
engine oil filter Motorölfilter	8	080749
fuel filter Kraftstofffilter	8	043277
filter water separator Filter Wasserabscheider	8	083176
filter heater Filter Heizung	2	107202
filter heater, outside Filter Heizung (außen)	2	107060
air filter safety cartridge Sicherheitspatrone Luftfilter	2	149255
air filter replacement cartridge Austauschpatrone Luftfilter	2	149256
V-belt alternator Keilriemen Lichtmaschine	2	072533
V-belt water pump Keilriemen Wasserpumpe	2	099128
V-belt air conditioner Keilriemen Klimaanlage	2	084264
244265 inspection set (2000 h) / Inspektionssatz (2000 h) 2200E (CAT C7.1 Tier 4f / IV, VF)		
return flow filter Rücklauffilter	2	151945
leakage oil filter Leckölfilter	4	027376
ventilation filter Belüftungsfilter	2	174541
breather filter Entlüftungsfilter	2	168306

Description / Bezeichnung	Qty. / St.	No. / Nr.
auxiliary control filter Vorsteuerfilter	2	150308
engine oil filter Motorölfilter	4	177580
fuel filter Kraftstofffilter	8	219995
filter water separator Filter Wasserabscheider	4	171162
filter heater, inside Filter Heizung, innen	2	107202
filter heater, outside Filter Heizung, außen	2	107060
air filter safety cartridge Sicherheitspatrone Luftfilter	2	149255
air filter replacement cartridge Austauschpatrone Luftfilter	2	149256
V-belt fan drive Keilriemen Lüfterantrieb	1	198272
244266 inspection set (2000 h) / Inspektionssatz (2000 h) 2200E (CAT C7.1 Tier 4f / IV, HC)		
return flow filter Rücklauffilter	2	151945
leakage oil filter Leckölfilter	4	027376
ventilation filter Belüftungsfilter	2	174541
breather filter Entlüftungsfilter	2	168306
HydroClean HydroClean	2	150309
engine oil filter Motorölfilter	4	177580
fuel filter Kraftstofffilter	8	219995
filter water separator Filter Wasserabscheider	4	171162
filter heater, inside Filter Heizung, innen	2	107202
filter heater, outside Filter Heizung, außen	2	107060
air filter safety cartridge Sicherheitspatrone Luftfilter	2	149255
air filter replacement cartridge Austauschpatrone Luftfilter	2	149256
V-belt fan drive Keilriemen Lüfterantrieb	1	198272
162813 inspection set (2000 h) / Inspektionssatz (2000 h) 3300 (Cat C7 Tier 3 / IIIA, VF)		
return flow filter Rücklauffilter	6	150307
leakage oil filter Leckölfilter	4	027376
ventilation filter Belüftungsfilter	2	057228
auxiliary control filter Vorsteuerfilter	2	150308
engine oil filter Motorölfilter	8	080749
fuel filter Kraftstofffilter	8	043277
filter water separator Filter Wasserabscheider	8	083176
filter heater Filter Heizung	2	107202
filter heater, outside Filter Heizung (außen)	2	107060
air filter safety cartridge Sicherheitspatrone Luftfilter	2	064200
air filter replacement cartridge Austauschpatrone Luftfilter	2	118606

Description / Bezeichnung	Qty. / St.	No. / Nr.
V-belt alternator Keilriemen Lichtmaschine	2	072533
V-belt water pump Keilriemen Wasserpumpe	2	099128
V-belt air conditioner Keilriemen Klimaanlage	2	084264
162814 inspection set (2000 h) / Inspektionssatz (2000 h) 3300 (Cat C7 Tier 3 / IIIA, HC)		
return flow filter Rücklauffilter	6	150307
leakage oil filter Leckölfilter	4	027376
ventilation filter Belüftungsfilter	2	057228
HydroClean HydroClean	2	150309
engine oil filter Motorölfilter	8	080749
fuel filter Kraftstofffilter	8	043277
filter water separator Filter Wasserabscheider	8	083176
filter heater Filter Heizung	2	107202
filter heater, outside Filter Heizung (außen)	2	107060
air filter safety cartridge Sicherheitspatrone Luftfilter	2	064200
air filter replacement cartridge Austauschpatrone Luftfilter	2	118606
V-belt alternator Keilriemen Lichtmaschine	2	072533
V-belt water pump Keilriemen Wasserpumpe	2	099128
V-belt air conditioner Keilriemen Klimaanlage	2	084264
162815 inspection set (2000 h) / Inspektionssatz (2000 h) 5500 (Cat C9 Tier 3 / IIIA, VF)		
return flow filter Rücklauffilter	6	150307
leakage oil filter Leckölfilter	4	027376
ventilation filter Belüftungsfilter	2	057228
auxiliary control filter Vorsteuerfilter	2	150308
engine oil filter Motorölfilter	8	085693
fuel filter Kraftstofffilter	8	043277
filter water separator Filter Wasserabscheider	8	083176
filter heater Filter Heizung	2	107202
filter heater, outside Filter Heizung (außen)	2	107060
air filter safety cartridge Sicherheitspatrone Luftfilter	2	068827
air filter replacement cartridge Austauschpatrone Luftfilter	2	068826
V-belt alternator Keilriemen Lichtmaschine	1	093632
V-belt water pump Keilriemen Wasserpumpe	1	093633
V-belt air conditioner Keilriemen Klimaanlage	1	084264

14.5 INSPECTION SETS (2000 H) / INSPEKTIONSSÄTZE (2000 H)

Description / Bezeichnung	Qty. / St.	No. / Nr.
162816 inspection set (2000 h) / Inspektionssatz (2000 h) 5500 (Cat C9 Tier 3 / IIIA, HC)		
return flow filter Rücklauffilter	6	150307
leakage oil filter Leckölfilter	4	027376
ventilation filter Belüftungsfilter	2	057228
HydroClean HydroClean	2	150309
engine oil filter Motorölfilter	8	085693
fuel filter Kraftstofffilter	8	043277
filter water separator Filter Wasserabscheider	8	083176
filter heater Filter Heizung	2	107202
filter heater, outside Filter Heizung (außen)	2	107060
air filter safety cartridge Sicherheitspatrone Luftfilter	2	068827
air filter replacement cartridge Austauschpatrone Luftfilter	2	068826
V-belt alternator Keilriemen Lichtmaschine	1	093632
V-belt water pump Keilriemen Wasserpumpe	1	093633
V-belt air conditioner Keilriemen Klimaanlage	1	084264
232399 inspection set (2000 h) / Inspektionssatz (2000 h) 5500E (CAT C9 Tier 3 / IIIA, VF)		
auxiliary control filter Vorsteuerfilter	2	150308
return flow filter Rücklauffilter	2	151945
leakage oil filter Leckölfilter	4	027376
ventilation filter Belüftungsfilter	2	153955
breather filter Entlüftungsfilter	2	168306
engine oil filter Motorölfilter	8	085693
fuel filter Kraftstofffilter	8	043277
filter water separator Filter Wasserabscheider	8	083176
air filter safety cartridge Sicherheitspatrone Luftfilter	2	146689
air filter replacement cartridge Austauschpatrone Luftfilter	2	146690
filter heater, inside Filter Heizung, innen	2	107202
filter heater, outside Filter Heizung, außen	2	107060
V-belt set (2 pcs.) Keilriemensatz(2 Stk.)	1	227767
V-belt water pump Keilriemen Wasserpumpe	1	093633
V-belt Keilriemen	1	059076
232400 inspection set (2000 h) / Inspektionssatz (2000 h) 5500E (CAT C9 Tier 3 / IIIA, HC)		
HydroClean HydroClean	2	150309
return flow filter Rücklauffilter	2	151945
leakage oil filter Leckölfilter	4	027376

Description / Bezeichnung	Qty. / St.	No. / Nr.
ventilation filter Belüftungsfilter	2	153955
breather filter Entlüftungsfilter	2	168306
engine oil filter Motorölfilter	8	085693
fuel filter Kraftstofffilter	8	043277
filter water separator Filter Wasserabscheider	8	083176
air filter safety cartridge Sicherheitspatrone Luftfilter	2	146689
air filter replacement cartridge Austauschpatrone Luftfilter	2	146690
filter heater, inside Filter Heizung, innen	2	107202
filter heater, outside Filter Heizung, außen	2	107060
V-belt set (2 pcs.) Keilriemensatz(2 Stk.)	1	227767
V-belt water pump Keilriemen Wasserpumpe	1	093633
V-belt Keilriemen	1	059076
231677 inspection set (2000 h) / Inspektionssatz (2000 h) 5500E (CAT C9.3 Tier 4f / IV, VF)		
engine oil filter Motorölfilter	4	085693
fuel filter Kraftstofffilter	8	040247
filter water separator Filter Wasserabscheider	4	083176
V-belt Keilriemen	1	205689
V-belt Keilriemen	1	170300
air filter safety cartridge Sicherheitspatrone Luftfilter	2	149255
air filter replacement cartridge Austauschpatrone Luftfilter	2	149256
auxiliary control filter Vorsteuerfilter	2	150308
return flow filter Rücklauffilter	2	151945
leakage oil filter Leckölfilter	4	027376
breather filter Entlüftungsfilter	2	168306
ventilation filter Belüftungsfilter	2	153955
filter heater Filter Heizung	2	107202
filter heater, outside Filter Heizung (außen)	2	107060
231678 inspection set (2000 h) / Inspektionssatz (2000 h) 5500E (CAT C9.3 Tier 4f / IV, HC)		
engine oil filter Motorölfilter	4	085693
fuel filter Kraftstofffilter	8	040247
filter water separator Filter Wasserabscheider	4	083176
V-belt Keilriemen	1	205689
V-belt Keilriemen	1	170300
air filter safety cartridge Sicherheitspatrone Luftfilter	2	149255
air filter replacement cartridge Austauschpatrone Luftfilter	2	149256

Description / Bezeichnung	Qty. / St.	No. / Nr.
HydroClean HydroClean	2	150309
return flow filter Rücklauffilter	2	151945
leakage oil filter Leckölfilter	4	027376
breather filter Entlüftungsfilter	2	168306
ventilation filter Belüftungsfilter	2	153955
filter heater Filter Heizung	2	107202
filter heater, outside Filter Heizung (außen)	2	107060
162817 inspection set (2000 h) / Inspektionssatz (2000 h) 7700 (Cat C11 Tier 3 / IIIA, VF)		
return flow filter Rücklauffilter	6	150307
leakage oil filter Leckölfilter	4	027376
ventilation filter Belüftungsfilter	2	057228
auxiliary control filter Vorsteuerfilter	2	150308
engine oil filter Motorölfilter	8	085693
fuel filter Kraftstofffilter	8	105680
filter water separator Filter Wasserabscheider	8	083176
filter heater Filter Heizung	2	107202
filter heater, outside Filter Heizung (außen)	2	107060
air filter safety cartridge Sicherheitspatrone Luftfilter	2	068827
air filter replacement cartridge Austauschpatrone Luftfilter	2	068826
V-belt alternator Keilriemen Lichtmaschine	1	076929
V-belt air conditioner Keilriemen Klimaanlage	1	105682
162818 inspection set (2000 h) / Inspektionssatz (2000 h) 7700 (Cat C11 Tier 3 / IIIA, HC)		
return flow filter Rücklauffilter	6	150307
leakage oil filter Leckölfilter	4	027376
ventilation filter Belüftungsfilter	2	057228
HydroClean HydroClean	2	150309
engine oil filter Motorölfilter	8	085693
fuel filter Kraftstofffilter	8	105680
filter water separator Filter Wasserabscheider	8	083176
filter heater Filter Heizung	2	107202
filter heater, outside Filter Heizung (außen)	2	107060
air filter safety cartridge Sicherheitspatrone Luftfilter	2	068827
air filter replacement cartridge Austauschpatrone Luftfilter	2	068826
V-belt alternator Keilriemen Lichtmaschine	1	076929
V-belt air conditioner Keilriemen Klimaanlage	1	105682

14.6 SERVICE BOXES

SERVICEKOFFER

Description / Bezeichnung	Notes / Bemerkung	Pcs. / St.	No. / Nr.
056270 DIN screw kit small <i>DIN-Schrauben-Set klein</i>			
hexagonal screw <i>Sechskantschraube</i>	DIN 933 M6x25-8.8 ZN	25	000068
hexagonal screw <i>Sechskantschraube</i>	DIN 933 M6x30-8.8 ZN	25	000069
hexagonal screw <i>Sechskantschraube</i>	DIN 933 M10x20-8.8 ZN	10	000078
hexagonal screw <i>Sechskantschraube</i>	DIN 933 M10x50-8.8 ZN	10	000084
hexagonal screw <i>Sechskantschraube</i>	DIN 933 M6x12-8.8 ZN	50	000356
hexagonal screw <i>Sechskantschraube</i>	DIN 933 M8x50-8.8 ZN	10	000357
hexagonal screw <i>Sechskantschraube</i>	DIN 933 M8x20-8.8 ZN	25	000838
hexagonal screw <i>Sechskantschraube</i>	DIN 933 M8x30-8.8 ZN	25	000840
hexagonal screw <i>Sechskantschraube</i>	DIN 933 M5x10-8.8 ZN	50	002227
hexagonal screw <i>Sechskantschraube</i>	DIN 933 M5x16-8.8 ZN	50	003542
hexagonal screw <i>Sechskantschraube</i>	DIN 933 M6x10-8.8 ZN	50	004930
hexagonal screw <i>Sechskantschraube</i>	DIN 933 M8x16-8.8 ZN	25	008680
hexagonal screw <i>Sechskantschraube</i>	DIN 933 M10x30-8.8 ZN	10	008695
hexagonal screw <i>Sechskantschraube</i>	DIN 933 M6x20-8.8 ZN	50	009049
hexagonal screw <i>Sechskantschraube</i>	DIN 933 M6x16-8.8 KA	50	009335
hexagonal screw <i>Sechskantschraube</i>	DIN 933 M8x40-8.8 ZN	10	015020
hexagonal screw <i>Sechskantschraube</i>	DIN 933 M10x40-8.8	10	015751
hexagonal screw <i>Sechskantschraube</i>	DIN 933 M5x20-8.8	50	126782
056271 DIN screw set middle <i>DIN-Schrauben-Set mittel</i>			
hexagonal screw <i>Sechskantschraube</i>	DIN 931 M16x60-8.8	10	000042
hexagonal screw <i>Sechskantschraube</i>	DIN 931 M16x65-8.8	10	000043
hexagonal screw <i>Sechskantschraube</i>	DIN 933 M16x70-8.8	10	000370
hexagonal screw <i>Sechskantschraube</i>	DIN 931 M16x80-8.8	10	000045
hexagonal screw <i>Sechskantschraube</i>	DIN 931 M16x90-8.8	10	000046
hexagonal screw <i>Sechskantschraube</i>	DIN 931 M16x100-8.8	5	000048
hexagonal screw <i>Sechskantschraube</i>	DIN 933 M16x40-8.8	10	000101
hexagonal screw <i>Sechskantschraube</i>	DIN 933 M16x45-8.8	10	000102
hexagonal screw <i>Sechskantschraube</i>	DIN 933 M16x50-8.8	10	000103
hexagonal screw <i>Sechskantschraube</i>	DIN 933 M16x30-8.8	10	000367
hexagonal screw <i>Sechskantschraube</i>	DIN 933 M16x35-8.8	10	000368
hexagonal screw <i>Sechskantschraube</i>	DIN 931 M16x75-10.9	10	007412
056272 DIN screw set large <i>DIN-Schrauben-Set groß</i>			
hexagonal screw <i>Sechskantschraube</i>	DIN 931 M10x55-8.8	10	000016
hexagonal screw <i>Sechskantschraube</i>	DIN 931 M10x60-8.8	10	000017

Description / Bezeichnung	Notes / Bemerkung	Pcs. / St.	No. / Nr.
hexagonal screw <i>Sechskantschraube</i>	DIN 931 M10x80-8.8	10	000019
hexagonal screw <i>Sechskantschraube</i>	DIN 931 M12x55-8.8	10	000025
hexagonal screw <i>Sechskantschraube</i>	DIN 931 M12x60-8.8	10	000026
hexagonal screw <i>Sechskantschraube</i>	DIN 931 M12x70-8.8	10	000027
hexagonal screw <i>Sechskantschraube</i>	DIN 931 M12x90-8.8	8	000028
hexagonal screw <i>Sechskantschraube</i>	DIN 931 M14x60-8.8	8	000036
hexagonal screw <i>Sechskantschraube</i>	DIN 931 M14x70-8.8	8	000038
hexagonal screw <i>Sechskantschraube</i>	DIN 931 M14x80-8.8	8	000039
hexagonal screw <i>Sechskantschraube</i>	DIN 933 M12x30-8.8	10	000091
hexagonal screw <i>Sechskantschraube</i>	DIN 933 M12x35-8.8	10	000092
hexagonal screw <i>Sechskantschraube</i>	DIN 933 M12x40-8.8	10	000093
hexagonal screw <i>Sechskantschraube</i>	DIN 933 M12x50-8.8	10	000094
hexagonal screw <i>Sechskantschraube</i>	DIN 933 M14x30-8.8	10	000096
hexagonal screw <i>Sechskantschraube</i>	DIN 933 M14x40-8.8	10	000098
hexagonal screw <i>Sechskantschraube</i>	DIN 933 M12x45-8.8	10	000361
hexagonal screw <i>Sechskantschraube</i>	DIN 933 M14x50-8.8	8	000365
hexagonal screw <i>Sechskantschraube</i>	DIN 931 M10x65-8.8	10	000816
hexagonal screw <i>Sechskantschraube</i>	DIN 931 M12x80-8.8	10	000821
hexagonal screw <i>Sechskantschraube</i>	DIN 931 M14x90-8.8	6	000825
hexagonal screw <i>Sechskantschraube</i>	DIN 931 M10x75-8.8	10	008759
hexagonal screw <i>Sechskantschraube</i>	DIN 931 M10x90-8.8	10	016354
hexagonal screw <i>Sechskantschraube</i>	DIN 931 M10x70-8.8	10	016707
056273 DIN small components <i>DIN-Kleinteile-Set</i>			
spring washer <i>Federring</i>	DIN 127 5 ZN	100	000190
spring washer <i>Federring</i>	DIN 127 10 ZN	100	000193
spring washer <i>Federring</i>	DIN 127 12 ZN	70	000194
spring washer <i>Federring</i>	DIN 127 14 ZN	50	000195
spring washer <i>Federring</i>	DIN 127 16 ZN	50	000196
spring washer <i>Federring</i>	DIN 127 8 ZN	100	000842
spring washer <i>Federring</i>	DIN 127 6 ZN	100	008940
washer <i>Scheibe</i>	DIN 125 13 ZN	50	000245
washer <i>Scheibe</i>	DIN 125 15 ZN	50	000246
washer <i>Scheibe</i>	DIN 125 8,4 ZN	100	000843
washer <i>Scheibe</i>	DIN 1440 16 ZN	50	007168
washer <i>Scheibe</i>	DIN 125 5,3 ST KA	100	009127

14.6 SERVICE BOXES / SERVICEKOFFER

Description / Bezeichnung	Notes / Bemerkung	Pcs. / St.	No. / Nr.
washer Scheibe	DIN 9021 5,3 KA	100	009282
washer Scheibe	DIN 9021 17 KA	20	102164
washer Scheibe	DIN 125 10,5 M5	100	000244
washer Scheibe	DIN 9021 13 ZN	20	011418
washer Scheibe	DIN 9021 6,4 ZN	100	012564
washer Scheibe	DIN 9021 8,4 ST	50	009124
washer Scheibe	DIN 125 6,4 ZN	100	000243
washer Scheibe	DIN 9021 10,5 ZN	50	014970
washer Scheibe	DIN 9021 15 ZN	20	046552
hexagonal nut Sechskantmutter	DIN 934 M12-8 ZN	30	000211
hexagonal nut Sechskantmutter	DIN 934 M16-8 ZN	20	000215
hexagonal nut Sechskantmutter	DIN 985 M8-8 ZN	100	000227
hexagonal nut Sechskantmutter	DIN 985 M10-8 ZN	50	000228
hexagonal nut Sechskantmutter	DIN 985 M12-8 ZN	30	000229
hexagonal nut Sechskantmutter	DIN 985 M14-8 ZN	25	000230
hexagonal nut Sechskantmutter	DIN 985 M16-8 ZN	20	000805
hexagonal nut Sechskantmutter	DIN 934 M8-8 ZN	10	000841
hexagonal nut Sechskantmutter	DIN 985 M5-8 ZN	100	000931
hexagonal nut Sechskantmutter	DIN 985 M6-8 ZN	100	000932
hexagonal nut Sechskantmutter	DIN 934 M14-8 LH ZN	25	008476
hexagonal nut Sechskantmutter	DIN 934 M5-8 KA	100	002433
hexagonal nut Sechskantmutter	DIN 934 M10-8 KA	50	010535
hexagonal nut Sechskantmutter	DIN 934 M6-8 ZN	100	010546
217476 O-ring-kit O-Ring-Set			
O-ring O-Ring	5x1,5 NBR 70	6	017563
O-ring O-Ring	5,28x1,78 NBR 70	6	015362
O-ring O-Ring	5,3x2,4 NBR 70	6	015510
O-ring O-Ring	6x1	6	023018
O-ring O-Ring	6x2 NBR 70	4	014629
O-ring O-Ring	6,02x2,62 NBR 90	6	028948
O-ring O-Ring	6,07x1,78 NBR 90	6	017619
O-ring O-Ring	7x1,5 NBR 70	4	012614
O-ring O-Ring	7x2,5	4	006563
O-ring O-Ring	7,5x1,5	4	023027
O-ring O-Ring	7,5x2 Viton 80	6	080396

Description / Bezeichnung	Notes / Bemerkung	Pcs. / St.	No. / Nr.
O-ring O-Ring	7,65x1,78 NBR 90	6	019581
O-ring O-Ring	7,65x1,78 Viton 90	6	074718
O-ring O-Ring	8x1,5 NBR 70	6	010849
O-ring O-Ring	8x2 NBR 70	4	015667
O-ring O-Ring	9x1	6	023019
O-ring O-Ring	9,25x1,78 NBR 90	6	019748
O-ring O-Ring	10x1,5	4	022908
O-ring O-Ring	10x2 Viton 80	6	031532
O-ring O-Ring	10x2,5	4	022921
O-ring O-Ring	10,5x2 Viton 90	6	039907
O-ring O-Ring	10,77x2,62 NBR 90	4	021427
O-ring O-Ring	10,82x1,78 NBR 70	6	016780
O-ring O-Ring	11x1,5	4	027342
O-ring O-Ring	11x1,78	6	023626
O-ring O-Ring	11x2 NBR 70	6	015363
O-ring O-Ring	11x2 Viton 80	6	081308
O-ring O-Ring	11x3 NBR 70	6	022647
O-ring O-Ring	11,2x2,4 Viton 70	6	022936
O-ring O-Ring	11,3x2,2	4	165737
O-ring O-Ring	11,3x2,4 Viton 80	0	081784
O-ring O-Ring	12x1,5 NBR 90	6	081373
O-ring O-Ring	12x2 NBR 70	6	049136
O-ring O-Ring	12x2,5 NBR 70	6	051425
O-ring O-Ring	12x4	4	020975
O-ring O-Ring	12,3x2,4	4	009090
O-ring O-Ring	12,37x2,62	6	024258
O-ring O-Ring	12,5x1 Viton 70	6	087277
O-ring O-Ring	12,7x1,5	4	009958
O-ring O-Ring	13x2 NBR 70	6	021489
O-ring O-Ring	13x2,5 NBR 70	6	000519
O-ring O-Ring	13,3x2,4	4	013533
O-ring O-Ring	13,6x2,7 70	4	027042
O-ring O-Ring	14x1,5	4	023289
O-ring O-Ring	14x1,78 NBR 90	6	015509
O-ring O-Ring	14x2	4	000553

14.6 SERVICE BOXES / SERVICEKOFFER

Description / Bezeichnung	Notes / Bemerkung	Pcs. / St.	No. / Nr.
O-ring O-Ring	14x2,5	4	000520
O-ring O-Ring	14x4	6	000521
O-ring O-Ring	15x1,5 NBR 70	6	015043
O-ring O-Ring	15x2 NBR 70	6	009931
O-ring O-Ring	15x2,5 NBR 70	6	026218
O-ring O-Ring	15,1x2,7	4	011950
O-ring O-Ring	15,3x2,4 NBR 70	6	022923
O-ring O-Ring	15,54x2,62 Viton 80	6	021556
O-ring O-Ring	15,54x2,62 NBR 90	4	055779
O-ring O-Ring	16x2	6	001247
O-ring O-Ring	16x2,5	4	024147
O-ring O-Ring	16x3	4	000522
O-ring O-Ring	16x4	4	000523
O-ring O-Ring	17x1,5 NBR 88	4	009880
O-ring O-Ring	17x2 NBR 70	6	001246
O-ring O-Ring	17x2,5	4	011704
O-ring O-Ring	17,12x2,62 NBR 90	6	075874
O-ring O-Ring	18x2 NBR 80	4	176930
O-ring O-Ring	18x2,5 NBR 80	6	003353
O-ring O-Ring	18x2,5 Viton 70	6	030310
O-ring O-Ring	18,6x3,5	4	013564
O-ring O-Ring	18,66x3,53 Viton 70	6	030306
O-ring O-Ring	18,72x2,62 NBR 90	6	015027
O-ring O-Ring	18,77x1,78 Viton 80	6	016781
O-ring O-Ring	18,77x1,8 Viton 80	4	081310
O-ring O-Ring	19x2	4	013059
O-ring O-Ring	19,3x2,4	6	027262
O-ring O-Ring	19,8x2,3	4	098086
O-ring O-Ring	20x2 NBR 70	6	001518
O-ring O-Ring	20x2,5 Viton 80	6	171354
O-ring O-Ring	20x3	6	008192
O-ring O-Ring	20,29x2,62 NBR 90	4	015649
O-ring O-Ring	20,3x2,4	4	009833
O-ring O-Ring	21x2 NBR 90	6	015668
O-ring O-Ring	21,92x3,53 Viton 80	6	008904

Description / Bezeichnung	Notes / Bemerkung	Pcs. / St.	No. / Nr.
O-ring O-Ring	22x3 NBR 70	6	004343
O-ring O-Ring	23x2	4	015723
O-ring O-Ring	23x3	4	017523
O-ring O-Ring	23,47x2,62 NBR 90	6	017621
O-ring O-Ring	23,5x2,5 Viton	6	030311
O-ring O-Ring	24x2,5 NBR 70	6	005646
O-ring O-Ring	24x3 NBR 70	6	000527
O-ring O-Ring	24,99x3,53 NBR 90	4	005581
O-ring O-Ring	25x2 NBR 80	6	025796
O-ring O-Ring	25x2,5 NBR 70	6	007586
O-ring O-Ring	25x3,5 NBR 90	6	002974
O-ring O-Ring	25x3,53 Viton 90	6	030307
O-ring O-Ring	26x2,5	6	132562
O-ring O-Ring	26x3	6	000529
O-ring O-Ring	26,2x3 90	6	069724
O-ring O-Ring	27x2	6	022744
O-ring O-Ring	27x3	4	000530
O-ring O-Ring	28x1	4	010473
O-ring O-Ring	28x2	4	009709
O-ring O-Ring	29x3	4	007638
O-ring O-Ring	29,75x3,53 NBR 90	6	006355
O-ring O-Ring	29,82x2,62 NBR 90	6	025232
O-ring O-Ring	29,87x1,78	4	015648
O-ring O-Ring	30x2 NBR 70	6	015906
O-ring O-Ring	31x2	3	009712
O-ring O-Ring	32x2,5	3	020694
O-ring O-Ring	32,92x3,53 NBR 90	4	008078
O-ring O-Ring	32,92x3,53 Viton 90	4	030308
O-ring O-Ring	32,92x3,55 Viton 80	4	080397
O-ring O-Ring	33x2,2 NBR	4	075712
O-ring O-Ring	33x2,5 NBR 70	4	012373
O-ring O-Ring	33x3	3	000533
O-ring O-Ring	34x3,5	3	021014
O-ring O-Ring	34,59x2,62 NBR 90	4	016391
O-ring O-Ring	34,59x2,62 Viton 80	4	071245

14.6 SERVICE BOXES / SERVICEKOFFER

Description / Bezeichnung	Notes / Bemerkung	Pcs. / St.	No. / Nr.
O-ring O-Ring	35x2 NBR 70	4	009715
O-ring O-Ring	35x2,5	4	019210
O-ring O-Ring	35x4 NBR 70	4	015994
O-ring O-Ring	36x3	3	001243
O-ring O-Ring	37x2,5 NBR	3	009716
O-ring O-Ring	37,7x3,53 Viton 90	4	030309
O-ring O-Ring	38x2 NBR 70	4	023475
O-ring O-Ring	38x2,2 NBR 70	3	066652
O-ring O-Ring	38x2,5 NBR 70	4	028081
O-ring O-Ring	38x3,5 NBR 70	4	014520
O-ring O-Ring	39,34x2,62 NBR 90	3	066079
O-ring O-Ring	40x2 Viton 80	4	081783
O-ring O-Ring	40x2,5	3	001244
O-ring O-Ring	40x3 NBR 70	4	000537
O-ring O-Ring	40,94x2,62 Viton 80	3	065830
O-ring O-Ring	40,95x2,62 NBR 70	4	009905
O-ring O-Ring	42x3 NBR 70	4	008714
O-ring O-Ring	42x4	3	003765
O-ring O-Ring	43x4 NBR 70	4	117340
O-ring O-Ring	45x2 NBR 70	3	055075
O-ring O-Ring	45x2,5	3	016289
O-ring O-Ring	45x3 NBR	4	000540
O-ring O-Ring	45x4 Viton	4	019179
O-ring O-Ring	46x3 NBR 70	4	024259
O-ring O-Ring	47x3	3	007880
O-ring O-Ring	47,22x3,53 NBR 80	4	005582
O-ring O-Ring	47,22x3,53 Viton 90	4	030314
O-ring O-Ring	48x2 NBR 70	4	055093
O-ring O-Ring	48x3 NBR 80	4	031997
O-ring O-Ring	50x2	3	036490
O-ring O-Ring	50x3 NBR 70	4	000542
O-ring O-Ring	50x4	3	001241
O-ring O-Ring	52,07x2,62	4	043155
O-ring O-Ring	53x3,5	4	049253
O-ring O-Ring	53,5x3,53	3	017895

Description / Bezeichnung	Notes / Bemerkung	Pcs. / St.	No. / Nr.
O-ring O-Ring	55x2,5	3	003654
O-ring O-Ring	55x3,5 NBR	4	024135
O-ring O-Ring	56,75x3,53 NBR 90	4	008079
O-ring O-Ring	56,75x3,53 Viton 90	4	040027
O-ring O-Ring	59,99x2,62	3	009957
O-ring O-Ring	60x4	3	000543
O-ring O-Ring	62x3	3	005818
O-ring O-Ring	62x4 NBR 90	4	012412
O-ring O-Ring	63,09x3,53 NBR 70	4	014468
O-ring O-Ring	65x2,5	3	018258
O-ring O-Ring	65x3	3	004860
O-ring O-Ring	66,34x2,62 NBR 70	3	021245
O-ring O-Ring	67,95x2,62 NBR 70	3	015031
O-ring O-Ring	70x5	3	003690
O-ring O-Ring	7,65x1,78 EPDM AC-hose / Klimaschlauch	6	099310
O-ring O-Ring	10,82x1,78 EPDM AC-hose / Klimaschlauch	6	099308
O-ring O-Ring	14x1,78 EPDM AC-hose / Klimaschlauch	6	099307
O-ring O-Ring	17,17x1,78 EPDM AC-hose / Klimaschlauch	6	099309
seal ring Dichtring	tube mounting 10 Rohrmontage 10	2	098503
seal ring Dichtring	tube mounting 12 Rohrmontage 12	2	098504
seal ring Dichtring	tube mounting 15 Rohrmontage 15	2	098505
seal ring Dichtring	tube mounting 16 Rohrmontage 16	2	098506
seal ring Dichtring	tube mounting 20 Rohrmontage 20	2	098507
seal ring Dichtring	tube mounting 25 Rohrmontage 25	2	098508
seal ring Dichtring	tube mounting 28 Rohrmontage 28	2	098509
seal ring Dichtring	tube mounting 30 Rohrmontage 30	2	098510
seal ring Dichtring	tube mounting 35 Rohrmontage 35	2	098511
seal ring Dichtring	tube mounting 38 Rohrmontage 38	2	097689
seal ring Dichtring	tube mounting 42 Rohrmontage 42	2	102182
217477 O-ring-kit - basic O-Ring-Set - Basis			
O-ring O-Ring	5x1,5 NBR 70	6	017563
O-ring O-Ring	5,28x1,78 NBR 70	6	015362
O-ring O-Ring	5,3x2,4 NBR 70	6	015510
O-ring O-Ring	6x1	6	023018
O-ring O-Ring	6,02x2,62 NBR 90	6	028948

14.6 SERVICE BOXES / SERVICEKOFFER

Description / Bezeichnung	Notes / Bemerkung	Pcs. / St.	No. / Nr.
O-ring O-Ring	6,07x1,78 NBR 90	6	017619
O-ring O-Ring	7,5x2 Viton 80	6	080396
O-ring O-Ring	7,65x1,78 NBR 90	6	019581
O-ring O-Ring	7,65x1,78 Viton 90	6	074718
O-ring O-Ring	8x1,5 NBR 70	6	010849
O-ring O-Ring	9x1	6	023019
O-ring O-Ring	9,25x1,78 NBR 90	6	019748
O-ring O-Ring	10x2 Viton 80	6	031532
O-ring O-Ring	10,5x2 Viton 90	6	039907
O-ring O-Ring	10,82x1,78 NBR 70	6	016780
O-ring O-Ring	11x1,78	6	023626
O-ring O-Ring	11x2 NBR 70	6	015363
O-ring O-Ring	11x2 Viton 80	6	081308
O-ring O-Ring	11x3 NBR 70	6	022647
O-ring O-Ring	11,2x2,4 Viton 70	6	022936
O-ring O-Ring	11,3x2,4 Viton 80	6	081784
O-ring O-Ring	12x1,5 NBR 90	6	081373
O-ring O-Ring	12x2 NBR 70	6	049136
O-ring O-Ring	12x2,5 NBR 70	6	051425
O-ring O-Ring	12,37x2,62	6	024258
O-ring O-Ring	12,5x1 Viton 70	6	087277
O-ring O-Ring	13x2 NBR 70	6	021489
O-ring O-Ring	13x2,5 NBR 70	6	000519
O-ring O-Ring	14x1,78 NBR 90	6	015509
O-ring O-Ring	14x4	6	000521
O-ring O-Ring	15x1,5 NBR 70	6	015043
O-ring O-Ring	15x2 NBR 70	6	009931
O-ring O-Ring	15x2,5 NBR 70	6	026218
O-ring O-Ring	15,3x2,4 NBR 70	6	022923
O-ring O-Ring	15,54x2,62 Viton 80	6	021556
O-ring O-Ring	16x2	6	001247
O-ring O-Ring	17x2 NBR 70	6	001246
O-ring O-Ring	17,12x2,62 NBR 90	6	075874
O-ring O-Ring	18x2,5 NBR 80	6	003353
O-ring O-Ring	18x2,5 Viton 70	6	030310

Description / Bezeichnung	Notes / Bemerkung	Pcs. / St.	No. / Nr.
O-ring O-Ring	18,66x3,53 Viton 70	6	030306
O-ring O-Ring	18,72x2,62 NBR 90	6	015027
O-ring O-Ring	18,77x1,78 Viton 80	6	016781
O-ring O-Ring	19,3x2,4	6	027262
O-ring O-Ring	20x2 NBR 70	6	001518
O-ring O-Ring	20x2,5 Viton 80	6	171354
O-ring O-Ring	20x3	6	008192
O-ring O-Ring	21x2 NBR 90	6	015668
O-ring O-Ring	21,92x3,53 Viton 80	6	008904
O-ring O-Ring	22x3 NBR 70	6	004343
O-ring O-Ring	23,47x2,62 NBR 90	6	017621
O-ring O-Ring	23,5x2,5 Viton	6	030311
O-ring O-Ring	24x2,5 NBR 70	6	005646
O-ring O-Ring	24x3 NBR 70	6	000527
O-ring O-Ring	25x2 NBR 80	6	025796
O-ring O-Ring	25x2,5 NBR 70	6	007586
O-ring O-Ring	25x3,5 NBR 90	6	002974
O-ring O-Ring	25x3,53 Viton 90	6	030307
O-ring O-Ring	26x2,5	6	132562
O-ring O-Ring	26x3	6	000529
O-ring O-Ring	26,2x3 90	6	069724
O-ring O-Ring	27x2	6	022744
O-ring O-Ring	29,75x3,53 NBR 90	6	006355
O-ring O-Ring	29,82x2,62 NBR 90	6	025232
O-ring O-Ring	30x2 NBR 70	6	015906
O-ring O-Ring	32,92x3,53 NBR 90	4	008078
O-ring O-Ring	32,92x3,53 Viton 90	4	030308
O-ring O-Ring	32,92x3,55 Viton 80	4	080397
O-ring O-Ring	33x2,2 NBR	4	075712
O-ring O-Ring	33x2,5 NBR 70	4	012373
O-ring O-Ring	34,59x2,62 NBR 90	4	016391
O-ring O-Ring	34,59x2,62 Viton 80	4	071245
O-ring O-Ring	35x2 NBR 70	4	009715
O-ring O-Ring	35x2,5	4	019210
O-ring O-Ring	35x4 NBR 70	4	015994

14.6 SERVICE BOXES / SERVICEKOFFER

Description / Bezeichnung	Notes / Bemerkung	Pcs. / St.	No. / Nr.
O-ring O-Ring	37,7x3,53 Viton 90	4	030309
O-ring O-Ring	38x2 NBR 70	4	023475
O-ring O-Ring	38x2,5 NBR 70	4	028081
O-ring O-Ring	38x3,5 NBR 70	4	014520
O-ring O-Ring	40x2 Viton 80	4	081783
O-ring O-Ring	40x3 NBR 70	4	000537
O-ring O-Ring	40,95x2,62 NBR 70	4	009905
O-ring O-Ring	42x3 NBR 70	4	008714
O-ring O-Ring	43x4 NBR 70	4	117340
O-ring O-Ring	45x3 NBR	4	000540
O-ring O-Ring	45x4 Viton	4	019179
O-ring O-Ring	46x3 NBR 70	4	024259
O-ring O-Ring	47,22x3,53 NBR 80	4	005582
O-ring O-Ring	47,22x3,53 Viton 90	4	030314
O-ring O-Ring	48x2 NBR 70	4	055093
O-ring O-Ring	48x3 NBR 80	4	031997
O-ring O-Ring	50x3 NBR 70	4	000542
O-ring O-Ring	52,07x2,62	4	043155
O-ring O-Ring	53x3,5	4	049253
O-ring O-Ring	55x3,5 NBR	4	024135
O-ring O-Ring	56,75x3,53 NBR 90	4	008079
O-ring O-Ring	56,75x3,53 Viton 90	4	040027
O-ring O-Ring	62x4 NBR 90	4	012412
O-ring O-Ring	63,09x3,53 NBR 70	4	014468
O-ring O-Ring	7,65x1,78 EPDM AC-hose / Klimaschlauch	6	099310
O-ring O-Ring	10,82x1,78 EPDM AC-hose / Klimaschlauch	6	099308
O-ring O-Ring	14x1,78 EPDM AC-hose / Klimaschlauch	6	099307
O-ring O-Ring	17,17x1,78 EPDM AC-hose / Klimaschlauch	6	099309
217478 O-ring-kit - extension O-Ring-Set - Erweiterung			
O-ring O-Ring	6x2 NBR 70	4	014629
O-ring O-Ring	7x1,5 NBR 70	4	012614
O-ring O-Ring	7x2,5	4	006563
O-ring O-Ring	7,5x1,5	4	023027
O-ring O-Ring	8x2 NBR 70	4	015667
O-ring O-Ring	10x1,5	4	022908

Description / Bezeichnung	Notes / Bemerkung	Pcs. / St.	No. / Nr.
O-ring O-Ring	10x2,5	4	022921
O-ring O-Ring	10,77x2,62 NBR 90	4	021427
O-ring O-Ring	11x1,5	4	027342
O-ring O-Ring	11,3x2,2	4	165737
O-ring O-Ring	12x4	4	020975
O-ring O-Ring	12,3x2,4	4	009090
O-ring O-Ring	12,7x1,5	4	009958
O-ring O-Ring	13,3x2,4	4	013533
O-ring O-Ring	13,6x2,7 70	4	027042
O-ring O-Ring	14x1,5	4	023289
O-ring O-Ring	14x2	4	000553
O-ring O-Ring	14x2,5	4	000520
O-ring O-Ring	15,1x2,7	4	011950
O-ring O-Ring	15,54x2,62 NBR 90	4	055779
O-ring O-Ring	16x2,5	4	024147
O-ring O-Ring	16x3	4	000522
O-ring O-Ring	16x4	4	000523
O-ring O-Ring	17x1,5 NBR 88	4	009880
O-ring O-Ring	17x2,5	4	011704
O-ring O-Ring	18x2 NBR 80	4	176930
O-ring O-Ring	18,6x3,5	4	013564
O-ring O-Ring	18,77x1,8 Viton 80	4	081310
O-ring O-Ring	19x2	4	013059
O-ring O-Ring	19,8x2,3	4	098086
O-ring O-Ring	20,29x2,62 NBR 90	4	015649
O-ring O-Ring	20,3x2,4	4	009833
O-ring O-Ring	23x2	4	015723
O-ring O-Ring	23x3	4	017523
O-ring O-Ring	24,99x3,53 NBR 90	4	005581
O-ring O-Ring	27x3	4	000530
O-ring O-Ring	28x1	4	010473
O-ring O-Ring	28x2	4	009709
O-ring O-Ring	29x3	4	007638
O-ring O-Ring	29,87x1,78	4	015648
O-ring O-Ring	31x2	3	009712

14.6 SERVICE BOXES / SERVICEKOFFER

Description / Bezeichnung	Notes / Bemerkung	Pcs. / St.	No. / Nr.
O-ring O-Ring	32x2,5	3	020694
O-ring O-Ring	33x3	3	000533
O-ring O-Ring	34x3,5	3	021014
O-ring O-Ring	36x3	3	001243
O-ring O-Ring	37x2,5 NBR	3	009716
O-ring O-Ring	38x2,2 NBR 70	3	066652
O-ring O-Ring	39,34x2,62 NBR 90	3	066079
O-ring O-Ring	40x2,5	3	001244
O-ring O-Ring	40,94x2,62 Viton 80	3	065830
O-ring O-Ring	42x4	3	003765
O-ring O-Ring	45x2 NBR 70	3	055075
O-ring O-Ring	45x2,5	3	016289
O-ring O-Ring	47x3	3	007880
O-ring O-Ring	50x2	3	036490
O-ring O-Ring	50x4	3	001241
O-ring O-Ring	53,5x3,53	3	017895
O-ring O-Ring	55x2,5	3	003654
O-ring O-Ring	59,99x2,62	3	009957
O-ring O-Ring	60x4	3	000543
O-ring O-Ring	62x3	3	005818
O-ring O-Ring	65x2,5	3	018258
O-ring O-Ring	65x3	3	004860
O-ring O-Ring	66,34x2,62 NBR 70	3	021245
O-ring O-Ring	67,95x2,62 NBR 70	3	015031
O-ring O-Ring	70x5	3	003690
seal ring Dichtring	tube mounting 10 Rohrmontage 10	2	098503
seal ring Dichtring	tube mounting 12 Rohrmontage 12	2	098504
seal ring Dichtring	tube mounting 15 Rohrmontage 15	2	098505
seal ring Dichtring	tube mounting 16 Rohrmontage 16	2	098506
seal ring Dichtring	tube mounting 20 Rohrmontage 20	2	098507
seal ring Dichtring	tube mounting 25 Rohrmontage 25	2	098508
seal ring Dichtring	tube mounting 28 Rohrmontage 28	2	098509
seal ring Dichtring	tube mounting 30 Rohrmontage 30	2	098510
seal ring Dichtring	tube mounting 35 Rohrmontage 35	2	098511
seal ring Dichtring	tube mounting 38 Rohrmontage 38	2	097689

Description / Bezeichnung	Notes / Bemerkung	Pcs. / St.	No. / Nr.
seal ring Dichtring	tube mounting 42 Rohrmontage 42	2	102182
113541 central lubrication kit Beka Max (825 - 840) Zentralschmierung-Set Beka Max (825 - 840)			
rotary connector Drehgelenk-Steckverbinder	M8k	2	104186
rotary connector Drehgelenk-Steckverbinder	M10x1k	2	104193
bolting Eckverschraubung	90°, M8x1,25k	2	112512
connector straight Gerader Steckverbinder	M10x1k	2	104189
connector straight Gerader Steckverbinder	M8x1k	2	104198
bush Hülse	bolt bush Schraubhülse	15	108724
profile ring Profiling	6LL	10	166699
pipe Rohr	6 x 1,5 PA	1	126880
scissors Schere	hose scissors Schlauchschiere	1	150479
hose Schlauch	8,6x4	1	108716
protective spiral Schutzwendel	tube coil Rohrwendel	1	104192
plug connection Steckanschluss Rohrstopfen		10	108715
plug connection Steckanschluss Rohrstopfen		1	116328
plug connection Steckanschluss Rohrstopfen	90°, 33 mm	1	116329
crown nut Überwurfmutter	6LL	10	150480
connector Verbindungsstück	straight gerade	5	104188
cone extension Verlängerung kegelig	M10x1k	4	104190
cone extension Verlängerung konisch	M8x1,25 - M10x1	2	104194
elbow fitting angled Winkel-Steckverbinder	M8k	4	104185
elbow fitting angled Winkel-Steckverbinder	M10x1k	6	104187
swivel bolting Winkelverschraubung	M10x1k	2	116306
109049 central lubrication kit Beka Max (880) Zentralschmierung-Set Beka Max (880)			
sealing washer Dichtring		5	166699
sealing washer Dichtring		2	166699
seal Dichtung	P-R 8L/S	5	004690
bush Hülse		15	108724
bush Hülse	bolt bush Schraubhülse	5	109051
hydraulic hose Hydraulikschlauch	4-SH 25x2100 (380 bar)	1	109088
nut Mutter	M8L	5	004697
profile ring Profiling		2	158144
scissors Schere		1	150479
bulkhead fitting Schottverschraubung		1	155067
crown nut Überwurfmutter		5	150480

14.6 SERVICE BOXES / SERVICEKOFFER

Description / Bezeichnung	Notes / Bemerkung	Pcs. / St.	No. / Nr.
connector Verbindungsstück		6	104185
connector Verbindungsstück		10	104187
connector Verbindungsstück		5	104188
connector Verbindungsstück		2	104189
connector Verbindungsstück		5	108715
connector Verbindungsstück		5	109052
connector Verbindungsstück		5	109053
connector Verbindungsstück		1	109060
connector Verbindungsstück	ribbed gerillt	5	
threaded union Verschraubung		2	104194
threaded union Verschraubung		2	109056
threaded union Verschraubung	straight gerade	3	
076274 central lubrication kit Lincoln <i>Zentralschmierung-Set Lincoln</i>			
adapter Adapter	Gi G1/8, Ga M22x1,5	1	058799
connector Anschlusstück	Ga = M8, Gi = M8x1	10	022001
outlet bolting Auslassverschraubung	Ro-d = 6	30	077915
pressure limiter Druckbegrenzung	SVTSV-350-R1/4-6+NIP00R	1	043616
adjusting gauge Einstelllehre	hose integration Schlaucheinbindung	1	051666
bracket Halter		1	038116
bush Hülse	bolt bush Schraubhülse	20	037999
nipple Nippel		10	044345

Description / Bezeichnung	Notes / Bemerkung	Pcs. / St.	No. / Nr.
pipe Rohr	d = 8,4 x 2,1	25	038117
pipe Rohr	d = 6 x 1,5	50	038118
scissors Schere	plastic tube Kunststoffrohr	1	047928
protective spiral Schutzwendel	d = 6	5	038111
protective spiral Schutzwendel	d = 12	5	038112
valve Ventil	Rohr d = 6	10	043606
connector Verbindungsstück	grease hose high pressure Schmierschlauch, Hochdruck	10	077514
cone extension Verlängerung kegelig	Gi = M8x1, Ga = M8x1	10	038105
cone extension Verlängerung kegelig	Gi = M10x1, Ga = M10x1	20	038106
screw plug Verschlusschraube	M10x1	15	037972
threaded union Verschraubung	straight gerade (Schraubstutzen)	20	043613
distributor Verteiler	SSV 6	1	037962
distributor Verteiler	SSV 8	1	037963
distributor Verteiler	SSV 10	1	037964
tool Werkzeug	connector opener Lösen von Steckverbindungen	1	043612
elbow union Winkelverschraubung	WEDK 6520-6-M10x1-S01	10	037993
elbow union Winkelverschraubung	WEK 6500-6-M10x1-S01	20	077916
elbow union Winkelverschraubung	6L M8x1	20	077917
elbow union Winkelverschraubung	6L R1/8"	10	044432
elbow union Winkelverschraubung	WEDK 6520-6-1/8-S01	20	058800

14.7 HYDRAULIC BOXES HYDRAULIKKOFFER

Description / Bezeichnung	Notes / Bemerkung	Pcs. / St.	No. / Nr.
056274 SAE-flange kit <i>SAE-Flansch-Set</i>			
blank plate Blindteller	3/4", 6000	2	025270
blank plate Blindteller	1"	2	043348
blank plate Blindteller	1 1/4", 6000	2	043349
flange half Flanschhälfte	1 1/4", 6000	2	006604
flange half Flanschhälfte	1 1/2", 3000	2	006916
flange half Flanschhälfte	1", 6000	2	013178
flange half Flanschhälfte	3/4", 6000	4	014505

Description / Bezeichnung	Notes / Bemerkung	Pcs. / St.	No. / Nr.
flange half Flanschhälfte	3/4", 3000	4	014751
flange half Flanschhälfte	1", 3000	2	015050
flange half Flanschhälfte	1 1/4", 3000	4	015481
flange half Flanschhälfte	1 1/2", 6000	2	028082
pressure gauge connection Messanschluss	R 1/4"	2	166681
Seal-O-Ring O-Ring	25x3,53 FPM90 C2	10	030307
Seal-O-Ring O-Ring	32,92x3,53 FPM90 C2	10	030308
Seal-O-Ring O-Ring	37,7x3,53 FPM90 C2	10	030309

14.7 HYDRAULIC BOXES / HYDRAULIKKOFFER

Description / Bezeichnung	Notes / Bemerkung	Pcs. / St.	No. / Nr.
Seal-O-Ring O-Ring	47,22x3,53 FPM90 C5	10	030314
hexagonal nut Sechskantmutter	DIN 934 M12-8	10	000211
hexagonal nut Sechskantmutter	DIN 934 M14-8	10	000212
hexagonal nut Sechskantmutter	DIN 934 M10-8	10	010535
seal flange Verschlussflansch	3/4", 6000	1	012740
seal flange Verschlussflansch	1", 6000	1	013213
seal flange Verschlussflansch	1 1/2", 3000	1	028451
seal flange Verschlussflansch	3/4", 3000	1	029469
seal flange Verschlussflansch	1 1/4", 6000	1	032361
seal flange Verschlussflansch	1 1/4", 3000	1	049812
inter flange Zwischenflansch	1", 6000	1	015392
cylinder screw Zylinderschraube	DIN 912 M10x30-8.8	12	000112
cylinder screw Zylinderschraube	DIN 912 M10x35-8.8	12	000113
cylinder screw Zylinderschraube	DIN 912 M10x50-8.8	5	000116
cylinder screw Zylinderschraube	DIN 912 M12x30-8.8	8	000122
cylinder screw Zylinderschraube	DIN 912 M12x40-8.8	12	000124
cylinder screw Zylinderschraube	DIN 912 M12x55-8.8	4	000127
cylinder screw Zylinderschraube	DIN 912 M10x55-8.8	4	000885
cylinder screw Zylinderschraube	DIN 912 M14x70-8.8	4	000898
cylinder screw Zylinderschraube	DIN 912 M16x50-8.8	4	000901
cylinder screw Zylinderschraube	DIN 912 M12x65-8.8	12	018155
cylinder screw Zylinderschraube	DIN 912 M14x45-8.8	8	057984
040474 fitting kit Verschraubungen-Set			
hex spud straight Gerade-Einschraubstutzen	GES 10L/R1/2-WD	2	006842
hex spud straight Gerade-Einschraubstutzen	GES 16SR-WD	2	010266
hex spud straight Gerade-Einschraubstutzen	GES 12L/R1/4-WD	5	010471
hex spud straight Gerade-Einschraubstutzen	GES 10LR-WD	2	010925
hex spud straight Gerade-Einschraubstutzen	GES 8SM-WD	2	016616
hex spud straight Gerade-Einschraubstutzen	GE012LM14x1,5A3C	2	078424
hex spud straight Gerade-Einschraubstutzen	EGESD 12L/R1/4-WD	6	018279
adaptor straight Gerade-Reduzierstutzen	GS 12/10L	5	019349
connection straight Gerade-Stutzen	GS 20S	2	000731
connection straight Gerade-Stutzen	GS 15L	2	000732
connection straight Gerade-Stutzen	GS 12L	4	000733
connection straight Gerade-Stutzen	GS 25S	2	003341

Description / Bezeichnung	Notes / Bemerkung	Pcs. / St.	No. / Nr.
connection straight Gerade-Stutzen	GS 16S	2	004603
connection straight Gerade-Stutzen	GS 35L	2	004605
connection straight Gerade-Stutzen	GS 22L	2	020219
connection straight Gerade-Verbindung	SNV 16S	3	020123
connection straight Gerade-Verbindung	SNV 10L	4	021291
connection straight Gerade-Verbindung	SNV 12L	5	147821
connection straight Gerade-Verbindung	SNV 15L	2	024541
connection cross Kreuz-Stutzen	KS 12L	2	014819
L-connection adjustable L-Stutzen einstellbar	ELSD 12L	3	004638
L-connection adjustable L-Stutzen einstellbar	ELSD 10L	3	007675
L-connection adjustable L-Stutzen einstellbar	ELSD 15L	4	009534
reduction Reduzierstutzen	RESDSN 15/12L	2	003249
reduction Reduzierstutzen	RESDSN 12/10L	4	003781
T-connection adjustable T-Stutzen einstellbar	ETSD 12L	3	002339
T-connection adjustable T-Stutzen einstellbar	ETSD 10L	3	011405
screw plug Verschlusschraube	VSK 25S - M36x2	2	003859
screw plug Verschlusschraube	VSK 20S - M30x2	2	003860
screw plug Verschlusschraube	VSK 12L - M18x1,5	2	003861
screw plug Verschlusschraube	VSK 16S - M24x1,5	2	013638
sealing plug with L-nut Verschlussstopfen mit L-Mutter	VS 10L/S + M10L - M16x1,5	4	018556
sealing plug with L-nut Verschlussstopfen mit L-Mutter	VS 15L + M15L - M22x1,5	2	018762
sealing plug with L-nut Verschlussstopfen mit L-Mutter	VS 12L/S + M12L - M18x1,5	4	023468
sealing plug with L-nut Verschlussstopfen mit L-Mutter	VS 22L + M22L - M30x2	2	027774
sealing plug with S-nut Verschlussstopfen mit S-Mutter	VS 25S + M25S - M36x2	2	026385
sealing plug with S-nut Verschlussstopfen mit S-Mutter	VS 30S + M30S - M42x2	2	033806
sealing plug with S-nut Verschlussstopfen mit S-Mutter	VS 20S + M20S - M30x2	2	039258
elbow fitting angled Winkel-Schwenkstutzen	RSWS 10LM	3	099838
elbow fitting angled Winkel-Schwenkstutzen	RSWS 10LR	2	004651
elbow fitting angled Winkel-Schwenkstutzen	RSWS 12LR	2	008321
elbow fitting adjustable Winkel-Stutzen einstellbar	EWSD 12L	5	000750
elbow fitting adjustable Winkel-Stutzen einstellbar	EWSD 15L	5	004659
elbow fitting adjustable Winkel-Stutzen einstellbar	EWSD 18L	4	018264
elbow fitting adjustable Winkel-Stutzen einstellbar	EWSD 22L	2	019494
elbow fitting adjustable Winkel-Stutzen einstellbar	EWSD 16S	3	019919
elbow fitting adjustable Winkel-Stutzen einstellbar	EWSD 12S	3	023737

14.8 ELECTRIC BOXES ELEKTRIKKOFFER

Description / Bezeichnung	Notes / Bemerkung	Pcs. / St.	No. / Nr.
169166 electric box / Green Line E-series <i>Elektrik-Koffer / Green Line E-Serie</i>			
adapter plug <i>Steckhülse</i>	flat <i>flach</i>	10	085638
adapter plug <i>Steckhülse</i>	flat <i>flach</i>	10	218069
adapter plug <i>Steckhülse</i>	flat <i>flach</i>	10	110295
adapter plug <i>Steckhülse</i>	flat <i>flach</i>	10	067094
adapter plug <i>Steckhülse</i>		10	086884
adapter <i>Adapter</i>	valve connector LED <i>Ventilstecker LED</i>	2	110593
battery disconnecting switch <i>Batterietrennschalter</i>	24 V DC / 1000A	1	067815
bush <i>Tülle</i>	JPT, 2-pole <i>JPT, zweipolig</i>	1	045336
connector <i>Steckverbinder</i>		1	089326
coupling <i>Kupplung elektrisch</i>	5-pole, straight <i>5-polig, gerade PG9</i>	1	057419
crimp type contact <i>Crimpkontakt</i>		10	045338
crimp type contact <i>Crimpkontakt</i>	pin, gold plated <i>Stift, vergoldet</i>	20	048750
crimp type contact <i>Crimpkontakt</i>	socket, gold plated <i>Buchse, vergoldet</i>	20	048749
diode <i>Diode</i>	5A FK1	3	110187
diode <i>Diode</i>	diode modul <i>Diodenmodul, 4-fach</i>	1	014033
extractor tool <i>Auszehwerkzeug</i>	blue <i>blau</i>	2	040176
extractor tool <i>Auszehwerkzeug</i>	red <i>rot</i>	2	038135
extractor tool <i>Auszehwerkzeug</i>	yellow <i>gelb</i>	2	073595
fuse <i>Sicherung</i>	10 A	5	067083
fuse <i>Sicherung</i>	135 A	1	169292
fuse <i>Sicherung</i>	15 A	5	067084
fuse <i>Sicherung</i>	1 A	5	110268
fuse <i>Sicherung</i>	20 A	5	067085
fuse <i>Sicherung</i>	25 A	5	067086
fuse <i>Sicherung</i>	2 A	5	110270
fuse <i>Sicherung</i>	30 A	5	110272
fuse <i>Sicherung</i>	3 A	5	067080
fuse <i>Sicherung</i>	40 A	1	110178
fuse <i>Sicherung</i>	5 A	5	067081
fuse <i>Sicherung</i>	7,5 A	5	067082
fuse <i>Sicherung</i>	80 A	1	110171
housing <i>Gehäuse</i>	JPT, 2-pole <i>JPT, zweipolig</i>	1	045337

Description / Bezeichnung	Notes / Bemerkung	Pcs. / St.	No. / Nr.
ignition lock <i>Zündschloss</i>	P-0-1-2-Start	1	110172
lightning <i>Leuchtmittel</i>	Typ H3	2	050656
lightning <i>Leuchtmittel</i>	Typ H4	2	038488
multimeter <i>Multimeter</i>		1	037608
niveau switch <i>Niveauschalter</i>	coolant <i>Kühlwasser</i>	1	156174
niveau switch <i>Niveauschalter</i>	engine oil <i>Motoröl</i>	1	036401
plug base <i>Stecksackel</i>		1	086883
plug base <i>Stecksackel</i>		1	146842
plug base <i>Stecksackel</i>		1	086880
plug base <i>Stecksackel</i>		1	086882
plug <i>Stecker</i>	1,5-2,5 mm ²	10	067278
plug <i>Stecker</i>	24 V	2	068608
plug <i>Stecker</i>	5 pol.	1	044129
plug <i>Stecker</i>	9,5 mm	5	110367
potentiometer <i>Potentiometer</i>	0-10k Ohm, 2-5 Nm	1	089666
pressure switch <i>Druckschalter</i>	1 - 10 bar	1	037693
pressure switch <i>Druckschalter</i>	100 bar, M10x1 keg.	1	020098
pressure switch <i>Druckschalter</i>	5 bar, M12x1,5	1	018237
pressure switch <i>Druckschalter</i>	change-over-contact <i>Wechslerkontakt</i>	1	074011
pressure switch <i>Druckschalter</i>	change-over-contact <i>Wechslerkontakt</i>	1	095675
protection cap <i>Schutzkappe</i>	-40°C / + 85°C	1	155093
relay <i>Relais</i>	1,5 Hz / 21 W	1	014258
relay <i>Relais</i>	24 V	1	110207
relay <i>Relais</i>	24 V 10 A/20 A	1	110146
relay <i>Relais</i>	24 V DC	1	151888
relay <i>Relais</i>	24 V DC / 20/10 A	3	009729
relay <i>Relais</i>	24 V, 10 A	1	086707
relay <i>Relais</i>	24 V, 25A/25 A	1	138590
relay <i>Relais</i>	24 V DC, 100 A	1	069720
resistor <i>Widerstand</i>	121 Ohm	1	146841
resistor <i>Widerstand</i>	220 Ohm	1	110447
resistor <i>Widerstand</i>	24 V 6,0/3,0/1,5 Ohm	1	138357
sensor <i>Sensor</i>	induktiv	1	054109

14.8 ELECTRIC BOXES / ELEKTRIKKOFFER

Description / Bezeichnung	Notes / Bemerkung	Pcs. / St.	No. / Nr.	Description / Bezeichnung	Notes / Bemerkung	Pcs. / St.	No. / Nr.
solenoid coil Magnetspule	24 V / 14 W (JPT)	1	106994	extractor tool Ausziehwerkzeug	blue blau	2	040176
solenoid coil Magnetspule	24 V / 17 W (DT04)	1	134099	extractor tool Ausziehwerkzeug	red rot	2	038135
solenoid coil Magnetspule	24 V / 20 W (JPT)	1	108742	extractor tool Ausziehwerkzeug	yellow gelb	2	073595
solenoid coil Magnetspule	24 V / 42 W (JPT)	1	107669	fuse Sicherung	10 A	5	067083
solenoid coil Magnetspule	27 V / 20 W (DT04)	1	182510	fuse Sicherung	15 A	5	067084
solenoid coil Magnetspule	27 V / 20 W (JPT)	2	166195	fuse Sicherung	1 A	5	110268
switch Schalter		1	043706	fuse Sicherung	20 A	5	067085
switch Schalter	0-R	1	110293	fuse Sicherung	25 A	5	067086
switch Schalter	0-R-R	1	110286	fuse Sicherung	2 A	5	110270
switch Schalter	0-T	1	110324	fuse Sicherung	30 A	5	110272
switch Schalter	28 V/15 A, -40°C bis + 85°C	1	155092	fuse Sicherung	3 A	5	067080
switch Schalter	3 way 3-stufig	1	015215	fuse Sicherung	40 A	1	110178
switch Schalter	M16 x 1	1	033723	fuse Sicherung	5 A	5	067081
switch Taster	windscreen wiper Waschanlage Frostscheibe	1	157288	fuse Sicherung	7,5 A	5	067082
115489 electric box / Green Line D-series Elektrik-Koffer / Green Line D-Serie				fuse Sicherung	80 A	1	110171
adapter plug Steckhülse	flat flach	10	085638	fuse Sicherung	bolt-down	1	110180
adapter plug Steckhülse	flat flach	10	218069	housing Gehäuse	JPT, 2-pole JPT, zweipolig	1	045337
adapter plug Steckhülse	flat flach	10	110295	ignition lock Zündschloss	P-0-1-2-Start	1	110172
adapter plug Steckhülse	flat flach	10	067094	lightning Leuchtmittel	Typ H3	2	050656
adapter plug Steckhülse		10	086884	lightning Leuchtmittel	Typ H4	2	038488
adapter Adapter	eco switch ECO	1	096967	lightning Leuchtmittel		2	040136
adapter Adapter	valve connector LED Ventilstecker LED	2	110593	multimeter Multimeter		1	037608
battery disconnecting switch Batterietrennschalter	24 V DC / 1000A	1	067815	niveau switch Niveauschalter	coolant Kühlwasser	1	039346
bush Tülle	JPT, 2-pole JPT, zweipolig	1	045336	niveau switch Niveauschalter	engine oil Motoröl	1	036401
cable Kabel	with plug mit Stecker	1	037690	plug base Stecksackel	9-pole 9-polig	1	009728
connector Steckverbinder		1	089326	plug base Stecksackel		1	086882
contact element Kontaktetelement		1	039069	plug base Stecksackel		1	086880
coupling Kupplung elektrisch	5-pole, straight 5-polig, gerade PG9	1	057419	plug base Stecksackel		1	146842
crimp type contact Crimpkontakt		10	045338	plug base Stecksackel		1	086883
crimp type contact Crimpkontakt	pin, gold plated Stift, vergoldet	20	048750	plug Stecker	1,5-2,5 mm ²	10	067278
crimp type contact Crimpkontakt	socket, gold plated Buchse, vergoldet	20	048749	plug Stecker	24 V	2	068608
diode Diode	5 A FK1	3	110187	plug Stecker	5 pol.	1	044129
diode Diode	diode modul Diodenmodul, 4-fach	1	014033	plug Stecker	9,5 mm	5	110367

14.8 ELECTRIC BOXES / ELEKTRIKKOFFER

Description / Bezeichnung	Notes / Bemerkung	Pcs. / St.	No. / Nr.	Description / Bezeichnung	Notes / Bemerkung	Pcs. / St.	No. / Nr.
potentiometer <i>Potentiometer</i>	0-10k Ohm, 2-5 Nm	1	089666	switch <i>Schalter</i>	3 way 3-stufig	1	015215
potentiometer <i>Potentiometer</i>		1	086331	switch <i>Schalter</i>	cabin up <i>Kabine auf</i>	1	110262
pressure switch <i>Druckschalter</i>	1 - 10 bar	1	037693	switch <i>Schalter</i>	emergency stop <i>Not-Aus</i>	1	110181
pressure switch <i>Druckschalter</i>	100 bar, M10x1 keg.	1	020098	switch <i>Schalter</i>	filter service <i>Filterverschmutzung</i>	1	110208
pressure switch <i>Druckschalter</i>	5 bar, M12x1,5	1	018237	switch <i>Schalter</i>	GLR	1	110125
pressure switch <i>Druckschalter</i>	change-over-contact <i>Wechslerkontakt</i>	1	095675	switch <i>Schalter</i>	M16 x 1	1	033723
pressure switch <i>Druckschalter</i>	change-over-contact <i>Wechslerkontakt</i>	1	074011	switch <i>Schalter</i>		1	110284
pressure switch <i>Druckschalter</i>	n/o switch <i>Schließer</i>	1	022406	switch <i>Schalter</i>		1	110287
relay <i>Relais</i>	1,5 Hz / 21W	1	014258	114816 electric box / Green Line C-series CAT <i>Elektrik-Koffer / Green Line C-Serie CAT</i>			
relay <i>Relais</i>	24 V	1	110207	starter relay <i>Anlasserrelais</i>	24 V DC, 100 A	1	069720
relay <i>Relais</i>	24 V 10A/20A	1	110146	crimp type contact <i>Crimpkontakt</i>		2	045338
relay <i>Relais</i>	24 V DC	1	151888	diode <i>Diode</i>	diode modul <i>Diodenmodul, 3-fach</i>	1	068767
relay <i>Relais</i>	24 V DC / 20/10A	3	009729	button, metal <i>Drehknopf, Metall</i>	6 mm	1	088456
relay <i>Relais</i>	24 V, 10 A	1	086707	pressure switch <i>Druckschalter</i>	640 bar max	1	014474
relay <i>Relais</i>	24 V, 25 A/25 A	1	138590	pressure switch <i>Druckschalter</i>	5 bar, M12x1,5	1	018237
relay <i>Relais</i>	24 V DC, 100 A	1	069720	pressure switch <i>Druckschalter</i>	100 bar, M10x1 keg.	1	020098
relay <i>Relais</i>		1	124852	pressure switch <i>Druckschalter</i>	26 bar, M10x1	1	022406
relay <i>Relais</i>		1	129143	pressure switch <i>Druckschalter</i>	1 - 10 bar	1	037693
relay <i>Relais</i>		1	069449	pressure switch <i>Druckschalter</i>		1	018237
resistor <i>Widerstand</i>	121 Ohm	1	146841	pressure switch <i>Druckschalter</i>	0 - 400 bar, 1/4"	1	095675
resistor <i>Widerstand</i>	220 Ohm	1	110447	cable, brown <i>Fahrzeugleitung, braun</i>	FLR-Y TYP:B, 1 mm ²	1	051759
resistor <i>Widerstand</i>	24 V 6,0/3,0/1,5 Ohm	1	138357	cable, yellow <i>Fahrzeugleitung, gelb</i>	FLR-Y TYP:B, 1,5 mm ²	1	051793
sensor <i>Sensor</i>	induktiv	1	054109	cable, green <i>Fahrzeugleitung, grün</i>	FLR-Y TYP:B, 1 mm ²	1	051779
sensor <i>Sensor</i>	temperature <i>Temperatur</i>	1	037767	casing <i>Cehäuse</i>	timer 2-pole <i>Timer, 2-polig</i>	1	045337
solenoid coil <i>Magnetspule</i>	24 V / 14 W (JPT)	2	106994	casing <i>Cehäuse</i>	adapter plug <i>Steckhülse</i>	1	067105
solenoid coil <i>Magnetspule</i>	24 V / 17 W (DT04)	1	134099	lamp socket <i>Glühlampe</i>	24 V	5	014010
solenoid coil <i>Magnetspule</i>	24 V / 27 W (JPT)	1	154501	lighting <i>Glühlampe, Halogen</i>	Typ H4	2	038488
solenoid coil <i>Magnetspule</i>	24 V / 31 W (JPT)	1	107457	lighting <i>Glühlampe, Halogen</i>	Typ H3	2	050656
solenoid coil <i>Magnetspule</i>	24 V / 42 W (JPT)	1	107669	relay <i>Intervallrelais</i>	24 V DC	1	151888
solenoid coil <i>Magnetspule</i>	27 V / 20 W (JPT)	2	166195	contact block <i>Kontaktelement</i>	with adapter <i>mit Adapter</i>	1	072611
switch <i>Schalter</i>	0-R	1	110293	pilot lamp <i>Kontrollleuchte</i>	24 V DC	1	014009
switch <i>Schalter</i>	0-R-R	1	110286	coupling (flexible) <i>Kupplung elektrisch</i>	5-pole, straight PG9 <i>5-polig, gerade PG9</i>	1	057419
switch <i>Schalter</i>	0-T	1	110324	lighting <i>Leuchtmittel</i>	24 V	2	040136

14.8 ELECTRIC BOXES / ELEKTRIKKOFFER

Description / Bezeichnung	Notes / Bemerkung	Pcs. / St.	No. / Nr.	Description / Bezeichnung	Notes / Bemerkung	Pcs. / St.	No. / Nr.
solenoid coil Magnetspule	3 contacts 3 Anschlussfahnen	2	023102	plug base Stecksackel	9-pole 9-polig	1	009728
solenoid coil Magnetspule	14 W	1	079816	plug base Stecksackel	with diode MSD4 mit Diode MSD4	1	022081
multimeter Multimeter	digital LCD display digitale LCD-Anzeige	1	037608	switch Taster	pushbutton T-0-T Drucktastenschalter T-0-T	1	048315
control switch Niveauschalter	sensor oil minimum Sonde Ölminimum	1	036401	switch Taster	M22-D-5	1	072550
control switch Niveauschalter	coolant Kühlwasser	1	039346	temperature sensor Temperaturgeber	0 - 120°C	1	037767
potentiometer Potentiometer	R261	1	086331	bush Tülle	housing 2-pole Timergehäuse, 2-polig	1	045336
potentiometer Potentiometer	hand throttle Handgas	1	087740	switch Wahlschalter	3 step 3-stufig	1	015215
relay Relais	change over Wechsler	2	009729	Service indicator air filter Wartungsschalter Luftfilter		1	043706
relay Relais	direction indicator Blinkergeber	1	014258	change over switch Wechselschalter	0-R	1	014008
relay Relais	12 V	1	034215	resistance Widerstand	220 Ohm, 4W +/-5 %	1	027107
relay Relais	24 V DC, 2 x 150 W	1	038490	resistance Widerstand	resistance Vorwiderstand Kühlwasserheizg.	1	032492
relay Relais	24 V, I max 50 A	1	049507	time relay Zeitrelais, abfallverzögert	24 V	1	069449
switch Schalter	combi plug, 0-R-T Kombischalter, 0-R-T	1	045266	time relay Zeitrelais, anzugsverzögert	24 V, 10 A	1	086707
switch Schalter	on/off Ein/Aus-Schalter	1	067898	ignition lock Zündschloss	position P-0-1-2-start Stellung P-0-1-2-Start	1	027101
heat-shrinkable tubing Schrumpfschlauch	CTW 2,4/1,2	1	089673	159707 electric box / Green Line C-series DEUTZ <i>Elektrik-Koffer / Green Line C-Serie DEUTZ</i>			
protective cap Schutzkappe	G 1/4 A, IP 67	1	093977	starter relay Anlasserrelais	24 V DC	1	031258
sensor Sensor	inductive induktiv	1	054109	starter relay Anlasserrelais	24 V DC, 100 A	1	069720
safety switch armrest Sicherheitsschalter Armlehne	M16 x 1	1	033723	crimp type contact Crimpkontakt		2	045338
fuse Sicherung	5 A	10	067081	diode Diode	diode modul Diodenmodul, 3-fach	1	068767
fuse Sicherung	10 A	10	067083	button, metal Drehknopf, Metall	6 mm	1	088456
fuse Sicherung	15 A	10	067084	pressure switch Druckschalter	640 bar max	1	014474
fuse Sicherung	20 A	10	067085	pressure switch Druckschalter	5 bar, M12x1,5	1	018237
fuse Sicherung	25 A	10	067086	pressure switch Druckschalter	100 bar, M10x1 keg.	1	020098
fuse Sicherung	60 A	1	067901	pressure switch Druckschalter	26 bar, M10x1	1	022406
automatic fuse Sicherungsstreifen	80 A	1	061689	pressure switch Druckschalter	1 - 10 bar	1	037693
automatic fuse Sicherungsstreifen	125 A	1	067284	pressure switch Druckschalter	0 - 400 bar, 1/4"	1	095675
signal converter Signalwandler	0-10 V/PWM	1	079045	casing Gehäuse	timer 2-pole Timer, 2-polig	1	045337
plug Stecker	8-pole 8-polig	1	014000	casing Gehäuse	adapter plug Steckhülse	1	067105
plug Stecker	2-pole 2-polig	1	027594	lighting Glühlampe, Halogen	Typ H4	2	038488
plug Stecker	5-pole 5-polig	1	044129	lighting Glühlampe, Halogen	Typ H3	2	050656
plug with cable Stecker mit Kabel	24 V, 3 x 0,75 mm ²	1	037688	relay Intervallrelais	24 V DC	1	151888
plug with cable Stecker mit Kabel	24 V, 5 x 0,75 x 10 m	1	037690	cable Kabel	FLR-Y TYP:B, 1 mm ²	1	051759
adapter plug Steckhülse	0,5 - 1,5 mm ²	3	067092				

14.8 ELECTRIC BOXES / ELEKTRIKKOFFER

Description / Bezeichnung	Notes / Bemerkung	Pcs. / St.	No. / Nr.	Description / Bezeichnung	Notes / Bemerkung	Pcs. / St.	No. / Nr.
cable Kabel	FLR-Y TYP:B, 1 mm ²	1	051779	plug Stecker	8-pole 8-polig	1	014000
cable Kabel	FLR-Y TYP:B, 1,5 mm ²	1	051793	plug Stecker	2-pole 2-polig	1	027594
contact block Kontaktenelement	with adapter mit Adapter	1	072611	plug Stecker	5-pole 5-polig	1	044129
pilot lamp Kontrollleuchte	24 V DC	1	014009	plug with cable Stecker mit Kabel	24 V, 3 x 0,75 mm ²	1	037688
coupling (flexible) Kupplung elektrisch	5-pole, straight PG9 5-polig, gerade PG9	1	057419	plug with cable Stecker mit Kabel	24 V, 5 x 0,75 x 10 m	1	037690
lamp socket Lampenfassung	24 V	5	014010	adapter plug Steckhülse	flat flach	3	067092
lighting Leuchtmittel	24 V	2	040136	plug base Stecksackel	9-pole 9-polig	1	009728
solenoid coil Magnetspule	3 contacts 3 Anschlussfahnen	2	023102	plug base Stecksackel	with diode MSD4 mit Diode MSD4	1	022081
solenoid coil Magnetspule	14 W	1	079816	switch Taster	pushbutton T-0-T Drucktastenschalter T-0-T	1	048315
multimeter Multimeter	digital LCD display digitale LCD-Anzeige	1	037608	switch Taster	M22-D-S	1	072550
control switch Niveauschalter	sensor oil minimum Sonde Ölminimum	1	036401	temperature sensor Temperaturgeber	0 - 120°C	1	037767
control switch Niveauschalter	coolant Kühlwasser	1	039346	bush Tülle	housing 2-pole Timergehäuse, 2-polig	1	045336
potentiometer Potentiometer	R261	1	086331	resistance Vorwiderstand Kühlwasserheizg.		1	032492
potentiometer Potentiometer	hand throttle Handgas	1	087740	switch Wahlschalter	3 step 3-stufig	1	015215
relay Relais	24 V DC / 20/10 A	2	009729	service switch air filter Wartungsschalter Luftfilter		1	043706
relay Relais	direction indicator Blinkgeber	1	014258	resistance Widerstand	220 Ohm, 4W +/-5 %	1	027107
relay Relais	24 V DC, 2 x 150 W	1	038490	time relay Zeitrelais, abfallverzögert	24 V	1	069449
relay Relais	24 V, I max 50 A	1	049507	time relay Zeitrelais, anzugsverzögert	24 V, 10 A	1	086707
switch Schalter	change over switch Wechselschalter	1	014008	ignition lock Zündschloss	position P-0-1-2-start Stellung P-0-1-2-Start	1	027101
switch Schalter	combi plug, 0-R-T Kombischalter, 0-R-T	1	045266	039333 electric box / Green Line A/B-series Elektrik-Koffer / Green Line A/B-Serie			
switch Schalter	on/off Ein/Aus-Schalter	1	067898	starter relay Anlasserrelais	24 V DC	1	031258
heat-shrinkable tubing Schrumpfschlauch	CTW 2,4/1,2	1	089673	battery disconnecting switch Batterietrennschalter	max 2500 A / 24 V (10s)	1	013248
protective cap Schutzkappe	G 1/4 A, IP 67	1	093977	diode Diode	1 A, 1N 4007	1	034222
sensor Sensor	inductive induktiv	1	054109	pressure switch Druckschalter	640 bar max	1	014474
security switch armrest Sicherheitsschalter Armlehne	M16 x 1	1	033723	pressure switch Druckschalter	5 bar, M12x1,5	1	018237
fuse Sicherung	5 A	10	067081	pressure switch Druckschalter	100 bar, M10x1 keg.	1	020098
fuse Sicherung	10 A	10	067083	pressure switch Druckschalter	26 bar, M10x1	1	022406
fuse Sicherung	15 A	10	067084	pressure switch Druckschalter	1 - 10 bar	1	037693
fuse Sicherung	20 A	10	067085	fuse Flachsicherung	10 A	5	034624
fuse Sicherung	25 A	10	067086	fuse Flachsicherung	20 A	5	034625
fuse Sicherung	60 A	1	067901	contact block Kontaktenelement		1	039069
automatic fuse Sicherungsstreifen	80 A	1	061689	pilot lamp Kontrollleuchte	24 V DC	1	014009
automatic fuse Sicherungsstreifen	125 A	1	067284	lamp socket Lampenfassung	24 V	1	014010

14.8 ELECTRIC BOXES / ELEKTRIKKOFFER

Description / Bezeichnung	Notes / Bemerkung	Pcs. / St.	No. / Nr.	Description / Bezeichnung	Notes / Bemerkung	Pcs. / St.	No. / Nr.
lighting Leuchtmittel	24 V	2	040136	cable Kabel	with plug mit Stecker	1	037690
solenoid coil Magnetspule	3 contacts 3 Anschlussfahnen	2	023102	clip Klemme	0,2 - 0,6 mm ²	2	045334
solenoid coil Magnetspule		1	067144	clip Klemme	0,2 - 4 mm ²	2	037275
multimeter Multimeter	digital LCD display digitale LCD-Anzeige	1	037608	connector Steckverbinder	2 m, 3x0,75 mm ²	1	050841
control switch Niveauschalter	coolant Kühlwasser	1	039346	connector Steckverbinder	2 m, 5x0,34 mm ²	1	050843
potentiometer Potentiometer	hand throttle Handgas	1	089666	contact element Kontaktelement	with adapter mit Adapter	1	072611
relay Relais	change over Wechsler	2	009729	diode Diode	1 A, 1N 4007	2	034222
relay Relais	direction indicator Blinkergeber	1	014258	diode Diode	5 A FK1	3	110187
relay Relais	24 V, 70 A	1	049122	fuse Sicherung	10 A	5	034624
switch Schalter	combi plug, 0-R-T Kombischalter, 0-R-T	1	045266	fuse Sicherung	10 A	5	067083
sensor Sensor	inductive closer induktiv, Schließer	1	040869	fuse Sicherung	15 A	5	037527
sensor Sensor	inductive opener induktiv, Öffner	1	040870	fuse Sicherung	15 A	5	067084
sensor Sensor	inductive induktiv	1	054109	fuse Sicherung	20 A	5	034625
security switch armrest Sicherheitsschalter Armlehne	M16 x 1	1	033723	fuse Sicherung	20 A	5	067085
fuse Sicherung	40 A	1	030934	fuse Sicherung	30 A	5	110272
plug Stecker	8-pole 8-polig	1	014000	fuse Sicherung	40 A	1	110178
plug Stecker	2-pole 2-polig	1	027594	fuse Sicherung	80 A	1	110171
plug with cable Stecker mit Kabel	24 V, 3 x 0,75 mm ²	1	037688	fuse Sicherung	bolt-down	1	110180
plug with cable Stecker mit Kabel	24 V, 5 x 0,75 x 10 m	1	037690	ignition lock Zündschloss	P-0-1-2-Start	1	027101
plug base Stecksattel	9-pole 9-polig	1	009728	LED LED	modul + diode Modul + Diode	3	039017
plug base Stecksattel	with diode MSD4 mit Diode MSD4	1	022081	limit switch Endschalter	4-pole 4-polig	1	099530
switch Taster	RD-01	1	072550	limit switch Endschalter	6C-SU1 STW	1	001312
temperature sensor Temperaturgeber	0 - 120°C	1	037767	limit switch Endschalter	D-A1Z W	1	046891
resistance Vorwiderstand Kühlwasserheizg.		1	032492	multimeter Multimeter		1	037608
switch Wahlschalter	3 step 3-stufig	1	015215	niveau switch Niveauschalter	coolant Kühlwasser	1	039346
service switch air filter Wartungsschalter Luftfilter		1	043706	niveau switch Niveauschalter	engine oil Motoröl	1	036401
change over switch Wechselschalter	0-R	1	014008	plug base Stecksattel	with diode MSD4 mit Diode MSD4	1	022081
resistance Widerstand	220 Ohm, 4W +/-5 %	1	027107	plug Stecker	24 V	1	037691
time relay Zeitrelais, anzugsverzögert	24 V, 10 A	1	086707	plug Stecker	4-pole 4-polig	1	075301
ignition lock Zündschloss	position P-0-1-2-start Stellung P-0-1-2-Start	1	027101	plug Stecker	M12, 5-pole M12, 5-polig	1	249639
095390 electric-box / Crane Line <i>Elektrik-Koffer / Crane Line</i>				plug Stecker	with cable mit Kabel	1	037688
adapter Adapter	valve connector LED Ventilstecker LED	2	110593	plug Stecker	with diode mit Diode	1	037276
cable Kabel	can-bus Can-Bus	1	096774	potentiometer Potentiometer	0-10 kOhm, 2-5 Nm	1	089666

14.8 ELECTRIC BOXES / ELEKTRIKKOFFER

Description / Bezeichnung	Notes / Bemerkung	Pcs. / St.	No. / Nr.	Description / Bezeichnung	Notes / Bemerkung	Pcs. / St.	No. / Nr.
potentiometer <i>Potentiometer</i>		1	031524	switch <i>Schalter</i>	M22-WS	1	072551
pressure switch <i>Druckschalter</i>		1	072567	switch <i>Schalter</i>	T-0-T	1	048315
pressure switch <i>Druckschalter</i>		1	086331	switch <i>Schalter</i>		1	033723
pressure switch <i>Druckschalter</i>	1 - 10 bar	1	037693	168716 electric-box / Relay-Kit Telescopic Cranes <i>Elektrik-Koffer / Relais-Kit Telekrane</i>			
pressure switch <i>Druckschalter</i>	640 bar max	1	014474	diode <i>Diode</i>	5 A FK1	3	110187
pressure switch <i>Druckschalter</i>	change-over-contact <i>Wechslerkontakt</i>	1	095675	diode <i>Diode</i>	6 A	5	110297
relay <i>Relais</i>	24 V	1	069449	fuse <i>Sicherung</i>	10 A	10	034624
relay <i>Relais</i>	24 V	2	110207	fuse <i>Sicherung</i>	10 A	10	067083
relay <i>Relais</i>	24 V 10 A/20 A	1	110146	fuse <i>Sicherung</i>	15 A	10	037527
relay <i>Relais</i>	24 V DC / 20/10 A	4	009729	fuse <i>Sicherung</i>	15 A	10	067084
relay <i>Relais</i>	24 V DC, 16 A	2	039012	fuse <i>Sicherung</i>	20 A	10	034625
relay <i>Relais</i>	24 V DC, 5 A	2	039011	fuse <i>Sicherung</i>	20 A	10	067085
relay <i>Relais</i>	24 V DC	1	031258	fuse <i>Sicherung</i>	25 A	10	027541
relay <i>Relais</i>	24 V DC, 100 A	1	069720	fuse <i>Sicherung</i>	25 A	10	067086
relay <i>Relais</i>	change-over-contact <i>Wechslerkontakt</i>	1	109519	fuse <i>Sicherung</i>	2 A	10	110270
relay <i>Relais</i>		1	051934	fuse <i>Sicherung</i>	2 A	10	110357
relay <i>Relais</i>		1	129143	fuse <i>Sicherung</i>	30 A	10	110272
resistor <i>Widerstand</i>	121 Ohm	1	146841	fuse <i>Sicherung</i>	40 A	1	110178
resistor <i>Widerstand</i>	220 Ohm	1	110447	fuse <i>Sicherung</i>	5 A	10	067081
resistor <i>Widerstand</i>	24 V 6,0/3,0/1,5 Ohm	1	138357	fuse <i>Sicherung</i>	80 A	1	110171
sensor <i>Sensor</i>	temperature <i>Temperatur</i>	1	037767	fuse <i>Sicherung</i>	bolt-down	1	110180
solenoid coil <i>Magnetspule</i>	24 V / 12 W (DIN 43650)	2	023102	fuse <i>Sicherung</i>		10	055352
solenoid coil <i>Magnetspule</i>	24 V / 14 W (JPT)	2	106994	relay <i>Relais</i>	1,5 Hz / 21W	1	014258
solenoid coil <i>Magnetspule</i>	24 V / 14 W (DIN43650)	2	079816	relay <i>Relais</i>	24 V	1	067897
solenoid coil <i>Magnetspule</i>	24 V / 31 W (JPT)	1	107457	relay <i>Relais</i>	24 V	1	069449
solenoid coil <i>Magnetspule</i>	27 V / 20 W (JPT)	2	166195	relay <i>Relais</i>	24 V	2	110207
switch <i>Schalter</i>	0-R	1	014008	relay <i>Relais</i>	24 V 10 A/20 A	1	110146
switch <i>Schalter</i>	0-R	1	110293	relay <i>Relais</i>	24 V DC	1	151888
switch <i>Schalter</i>	0-R, locked <i>0-R, verriegelt</i>	1	045267	relay <i>Relais</i>	24 V DC / 20/10 A	4	009729
switch <i>Schalter</i>	0-R-R	1	110286	relay <i>Relais</i>	24 V DC, 2x150 W	1	038490
switch <i>Schalter</i>	3 way <i>3-stufig</i>	1	015215	relay <i>Relais</i>	24 V, 10 A	1	086707
switch <i>Schalter</i>	emergency stop <i>Not-Aus</i>	1	247396	relay <i>Relais</i>	24 V, 25 A/25 A	1	138590
switch <i>Schalter</i>	filter service <i>Filterverschmutzung</i>	1	043706	relay <i>Relais</i>	24 V DC, 100 A	1	069720

14.8 ELECTRIC BOXES / ELEKTRIKKOFFER

Description / Bezeichnung	Notes / Bemerkung	Pcs. / St.	No. / Nr.	Description / Bezeichnung	Notes / Bemerkung	Pcs. / St.	No. / Nr.
relay Relais		3	052641	pin-and-socket connector Steckverbinder	10 m	1	050841
relay Relais		1	067218	pin-and-socket connector Steckverbinder		1	050842
relay Relais		1	129143	pin-and-socket connector Steckverbinder	2-pole 2-polig	1	118729
168667 electric-box / plug + connectors <i>Elektrik-Koffer / Stecker + Steckverbinder</i>				pin-and-socket connector Steckverbinder	JPT Junior Power Timer - lose Ader	1	151087
adapter Adapter	valve plug LED Ventilstecker LED	1	110593	pin-and-socket connector Steckverbinder	JPT Junior Power Timer - 10 m	1	151087
extractor tool Ausziehwerkzeug	red rot	4	038135	pin housing Stiftgehäuse	timer, 2-pole Timer, 2-polig - JPT	2	129785
extractor tool Ausziehwerkzeug	blue blau	4	040176	ledge Stiftleiste	24-pole 24-polig	1	037630
extractor tool Ausziehwerkzeug	2,5 mm ² yellow 2,5 mm ² gelb	4	073595	ledge Stiftleiste	12-pole 12-polig	3	037631
socket board Buchsenleiste	24-pole 24-polig	1	037634	ledge Stiftleiste	2-pole 2-polig	3	037632
socket board Buchsenleiste	12-pole 12-polig	3	037635	ledge Stiftleiste	8-pole 8-polig	3	038129
socket board Buchsenleiste	2-pole 2-polig	3	037636	ledge Stiftleiste	3-pole 3-polig	3	038130
socket board Buchsenleiste	8-pole 8-polig	3	038131	ledge Stiftleiste	6-pole 6-polig	3	042678
socket board Buchsenleiste	3-pole 3-polig	3	038132	bush Tülle	housing, 2-pole Timergehäuse, 2-polig	1	045336
socket board Buchsenleiste	6-pole 6-polig	3	042679	valve plug, black Ventilstecker, schwarz	24 V	2	068608
crimp type contact Crimpkontakt	pin Stift	10	037637	valve plug, black Ventilstecker, schwarz	250 V	2	068609
crimp type contact Crimpkontakt	bush Buchse	10	037638	lock Verriegelung	pin, 3-pole Stift, 3-polig	3	040169
crimp type contact Crimpkontakt		12	045338	lock Verriegelung	socket, 3-pole Buchse, 3-polig	3	040170
crimp type contact Crimpkontakt	socket, gold plated Buchse, vergoldet	20	048749	lock Verriegelung	socket, 12-pole Buchse, 12-polig	3	040171
crimp type contact Crimpkontakt	pin, gold plated Stift, vergoldet	20	048750	lock Verriegelung	pin, 12-pole Stift, 12-polig	3	040172
seal Dichtung	spare seal Einzeldichtung	7	135926	lock Verriegelung	socket, 8-pole Buchse, 8-polig	3	040173
casing Gehäuse	timer 2-pole Timer, 2-polig	3	045337	lock Verriegelung	pin, 8-pole Stift, 8-polig	3	040174
tape Isolierband	coroplast, black Coroplast, schwarz	1	168668	lock Verriegelung	socket, 2-pole Buchse, 2-polig	3	042680
coupling (flexible) Kupplung elektrisch	black schwarz	2	013054	lock Verriegelung	pin, 6-pole Stift, 6-polig	3	042681
coupling (flexible) Kupplung elektrisch	5-pole, straight PG9 5-polig, gerade PG9	2	057419	lock Verriegelung	socket, 2-pole Buchse, 2-polig	3	042682
heat-shrinkable tubing Schrumpfschlauch	1,5 mm ²	3	073643	lock Verriegelung	socket, 6-pole Buchse, 6-polig	3	042683
heat-shrinkable tubing Schrumpfschlauch		3	089676	lock Verriegelung	socket, 4-pole Buchse, 4-polig	3	057612
plug socket Steckdose	4-pole 4-polig	3	057611	lock Verriegelung	pin, 4-pole Stift, 4-polig	3	057613
plug Stecker	24 V	2	037691				
plug Stecker	4-pole 4-polig	3	057610				
plug Stecker	pin, 2-pole Stift, 2-polig	2	122803				
plug with cable Stecker mit Kabel	15 mm x 10 m	1	037687				
plug with cable Stecker mit Kabel	24-pole 24-polig	1	037690				
plug base Stecksockel	with diode MSD4 mit Diode MSD4	2	022081				

14.9 TOOL BOXES WERKZEUGKOFFER

Description / Bezeichnung	Notes / Bemerkung	Pcs. / St.
161949 service box <i>Servicekoffer</i>		
ball-headed pin spanner set <i>Kugelpf-Stiftschlüsselsatz</i>	FAKKT SW 1,5 - 10	1
caliper <i>Messschieber</i>	150 mm	1
combination spanner <i>Gabelringschlüssel</i>	cranked 10 mm <i>gekröpft 10 mm</i>	1
combination spanner <i>Gabelringschlüssel</i>	cranked 13 mm <i>gekröpft 13 mm</i>	1
combination spanner <i>Gabelringschlüssel</i>	cranked 17 mm <i>gekröpft 17 mm</i>	1
combination spanner <i>Gabelringschlüssel</i>	cranked 19 mm <i>gekröpft 19 mm</i>	1
combination spanner <i>Gabelringschlüssel</i>	cranked 22 mm <i>gekröpft 22 mm</i>	1
dial gauge <i>Messuhr</i>	0 - 10 mm x 0,01	1
digital stopwatch <i>Digitale Stoppuhr</i>	IP 54	1
ear protection set <i>Gehörschutz-Stöpsel</i>	size m / l <i>M / L</i>	2
hard protective box <i>Hartschalenkoffer</i>	FAKKT	1
magnet measuring stativ <i>Magnet-Mess-Stativ</i>		1
manometer connection <i>Manometeranschluss</i>		3
manometer <i>Manometer</i>	0 - 60 bar	1
manometer <i>Manometer</i>	0 - 600 bar	2
measuring hose <i>Messschlauch</i>	630 bar	1
measuring hose <i>Messschlauch</i>	630 bar	2
illuminating hand magnifier <i>Handleuchtlupe</i>	LED 10x	1
open end spanner <i>Gabelschlüssel</i>	set 8 pcs. <i>Set 8tlg.</i>	1
pint hunter <i>Splinttreiber</i>	set 6 pcs. <i>Set 6tlg.</i>	1
power side cutter <i>Kraft-Seitenscheider</i>	FAKKT 180 mm	1
safety glasses <i>Schutzbrille</i>	Xc-Fogban PC klar	1
screw driver <i>Schraubendreher</i>	set 6 pcs. <i>Set 6tlg.</i>	1
slip joint plier <i>Wasserpumpenzange</i>	250 mm	1
socket spanner <i>Steckschlüsselsatz</i>	1/4" and 1/2" 50 pcs. <i>1/4" und 1/2" 50tlg.</i>	1
tachometer <i>Tachometer</i>	digital	1
VDE-long nose plier <i>VDE-Flachrundzange</i>	200 mm	1
Voltcraft VC150 DMM <i>Voltcraft VC150 DMM</i>		1
safety vest <i>Warnschutzweste</i>	EN 471 orange	1

Description / Bezeichnung	Notes / Bemerkung	Pcs. / St.
057624 tool box <i>Werkzeugkasten</i>		
3 square hollow scraper <i>3-Kant-Hohlschaber</i>	200 mm	1
accu lamp <i>Akkuleuchte</i>		1
ball-headed offset screwdriver <i>Kugelpf-Winkelschraubendreher</i>	FAKKT 9 pcs. <i>FAKKT 9tlg.</i>	1
box with insert <i>Montagekoffer mit Einsatz</i>	910 mm	1
combination spanner <i>Gabelringschlüssel</i>	set <i>Set</i>	1
cross screw driver <i>Kreuzschraubendreher</i>	set 3 pcs. <i>Set 3tlg.</i>	1
electric plier <i>Kombizange</i>	180 mm VDE-lagged <i>180 mm VDE-isoliert</i>	1
fitters hammer <i>Schlosserhammer</i>	with handle protection <i>mit Stielschutzhülle</i>	1
flat chisel <i>Flachmeißel</i>	FACTOR 250 mm	1
hand lamp <i>Handlampe</i>	24 V	1
hexagon socket spanner <i>Innensechskantschlüssel</i>	set 9 pcs. <i>Set 9tlg.</i>	1
impact drill and screw driver <i>Akku-Schlagbohrschrauber</i>	ELU 12 V	1
nylon hammer <i>Nylon-Hammer Gr. 50</i>	with hickory handle <i>mit Hickorystiel</i>	1
one-hand angle grinder <i>Einhandwinkelschleifer</i>	FEIN	1
open end spanner <i>Gabelschlüssel</i>	set <i>Set</i>	1
pin puncher <i>Splinttreiber</i>	FACTOR set 6 pcs. <i>FACTOR-Set 6tlg.</i>	1
plier <i>Presszange</i>	for cables <i>für Kabelverbindungen</i>	1
power screw driver <i>Kraftschraubendreher</i>	set 5 pcs. <i>Set 5tlg.</i>	1
power side cutter <i>Kraft-Seitenscheider</i>	200 mm	1
punch set <i>Durchschläger</i>	FACTOR set 6 pcs. <i>FACTOR-Set 6tlg.</i>	1
slip joint plier <i>Wasserpumpenzange</i>	300 mm	1
snap ring plier <i>Sicherungsringzangen</i>	set <i>Set</i>	1
snipe nose side cutting plier <i>Storchschnabelzange</i>	45° VDE-lagged <i>45° VDE-isoliert</i>	1
socket spanner <i>Steckschlüsselsatz</i>	Rahsol 24 pcs. <i>Rahsol 24tlg.</i>	1
spike bar <i>Nageleisen</i>	600 mm	1
threaded drill set <i>Bohrersatz</i>		1
torque spanner <i>Drehmomentschlüssel</i>	Torkofix-K 60 - 300 Nm	1
voltage tester <i>Spannungsprüfer</i>	DIGI CHECK	1

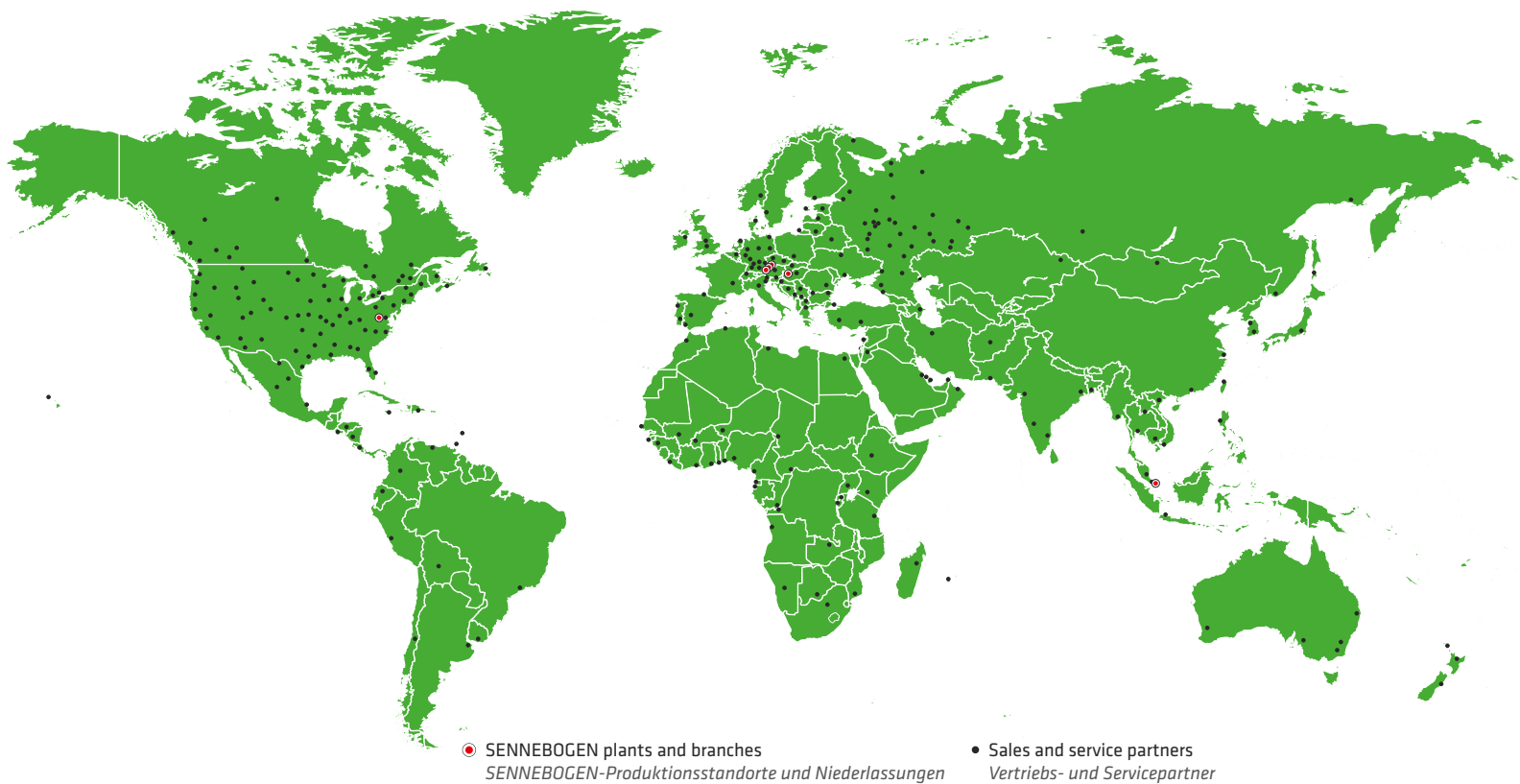

OUR SERVICE POINTS

UNSERE SERVICESTÜTZPUNKTE

Service Catalog - 261758 (2021)

CONTACT SPARE PARTS CENTER KONTAKT ERSATZTEILZENTRUM

Ordering spare parts
Ersatzteil-Bestellungen
spareparts@sennebogen.de

CONTACT CUSTOMER SERVICE KONTAKT KUNDENDIENST

Technical consulting
Technische Unterstützung
service@sennebogen.de