



Waste Management *Recycling*

Material Handling Machines
Materialumschlagmaschinen

SENBOGEN

The Recycling Experts – For every job the right machine

Die Recyclingexperten – Für jeden Einsatz die richtige Maschine

Material Handling Machine / Materialumschlagmaschine

pages / Seiten

817E	817 M	18,6 t 9 m 97 kW	ELECTRO BATTERY	817	18 t 9 m 75 kW	16 - 19	
822G	822 M	22 t 10 m 109 kW		822 R	24,3 t 10 m 109 kW	20 - 25	
824G	824 M	26,3 t 12 m 118 kW		824 R	27,3 t 12 m 118 kW	26 - 29	
826G	826 M	28,6 t 13 m 127 kW		826 R	31,7 t 13 m 127 kW	30 - 31	
825E	825 M	28,8 t 14 m 129 kW		825 R	32,8 t 14 m 129 kW	32 - 35	
			ELECTRO BATTERY	825	30,4 t 14 m 110 kW		
830E	830 M	38,5 t 17 m 168 kW		830 M HDS	41,5 t 17 m 168 kW	36 - 39	
				830 R	43 t 17 m 168 kW		
				830 R special	48 t 17 m 168 kW		
	830 Vario Tool	38,5 t 13 m 168 kW					
340G	340	4 t 7,7 m 100 kW		355E	355	5,5 t 8,5 m 123 kW	40 - 45

For every industry the right solution

Für jede Branche die richtige Lösung



Used paper / Altpapier



Waste wood / Altholz



Waste / Abfall



Used tires / Altreifen



Scrap / Schrott



Demolition waste / Bauschutt



2 All engine specifications in this brochure refer to EU standards (Stage V). Further technical information, also concerning Stage IIIa engines, can be found in the technical brochures.
Alle Motorangaben der Broschüre beziehen sich auf EU-Standard (Stufe V). Weitere technische Informationen, auch zu Stufe IIIa-Motoren, sind in den technischen Prospekten zu finden.

FAMILY BUSINESS

WITH DECADES OF EXPERIENCE –
YOU CAN RELY ON OUR TECHNICAL SOLUTIONS.

FAMILIENUNTERNEHMEN

MIT JAHRZEHNTELANGER ERFAHRUNG –
SETZEN SIE AUF UNSERE TECHNISCHEN LÖSUNGEN.

Since 1952, we stand for customer-specific mechanical engineering and have successfully established ourselves as market leader in many industries of crane technology and demanding material handling worldwide.

Seit 1952 stehen wir für kundenspezifischen Maschinenbau und haben uns erfolgreich als Marktführer in vielen Branchen der Krantechnik und des anspruchsvollen Materialumschlags weltweit etabliert.



FAMILY / FAMILIE SENNEBOGEN: ERICH, SEBASTIAN, ANTON, VICTORIA, ALEXANDER, WALTER (from left to right / von links nach rechts)



WE STAND FOR WIR STEHEN FÜR

MANAGEMENT BOARD / DIE GESCHÄFTSLEITUNG:
ALFRED ENDL, THORSTEN RESCH, WALTER SENNEBOGEN,
ERICH SENNEBOGEN, ANTON SENNEBOGEN,
DR. ANDREAS MAURER (from left to right / von links nach rechts)

STABILITY & RELIABILITY

Our stable and continuous development leads to the highest level of reliability and performance.

ORGANIC GROWTH AND INDEPENDENCE

For us this means future focus; for our partners and customers it brings long-term stability and security.

A STRONG HERITAGE SECURES THE FUTURE

SENNEBOGEN has become one of the leading manufacturers in the market. Continuous investments in our companies secure the advantage.

PROXIMITY TO OUR PARTNERS

The personal contact with our customers, distributors, suppliers or employees supports us in becoming better every day.

STABILITÄT UND ZUVERLÄSSIGKEIT

Unsere stabile und kontinuierliche Entwicklung führt zu einem Höchstmaß an Zuverlässigkeit und Leistungsfähigkeit.

ORGANISCHES WACHSTUM UND UNABHÄNGIGKEIT

Für uns bedeutet dies Zukunftsorientierung, für unsere Partner und Kunden langfristige Beständigkeit und Sicherheit.

STÄRKE SICHERT ZUKUNFT

SENNEBOGEN entwickelte sich zu einem führenden Hersteller am Markt. Kontinuierliche Investitionen in unsere Unternehmen sichern den Vorsprung.

NÄHE ZU UNSEREN PARTNERN

Die persönliche Begegnung mit unseren Kunden, Händlern, Lieferanten oder Mitarbeitern unterstützt uns dabei, jeden Tag besser zu werden.

WORLDWIDE CUSTOMER FOCUS.

WELTWEITE KUNDENORIENTIERUNG.

- Locations and branches /
Standorte und Niederlassungen
- Sales and service partners /
Vertriebs- und Servicepartner

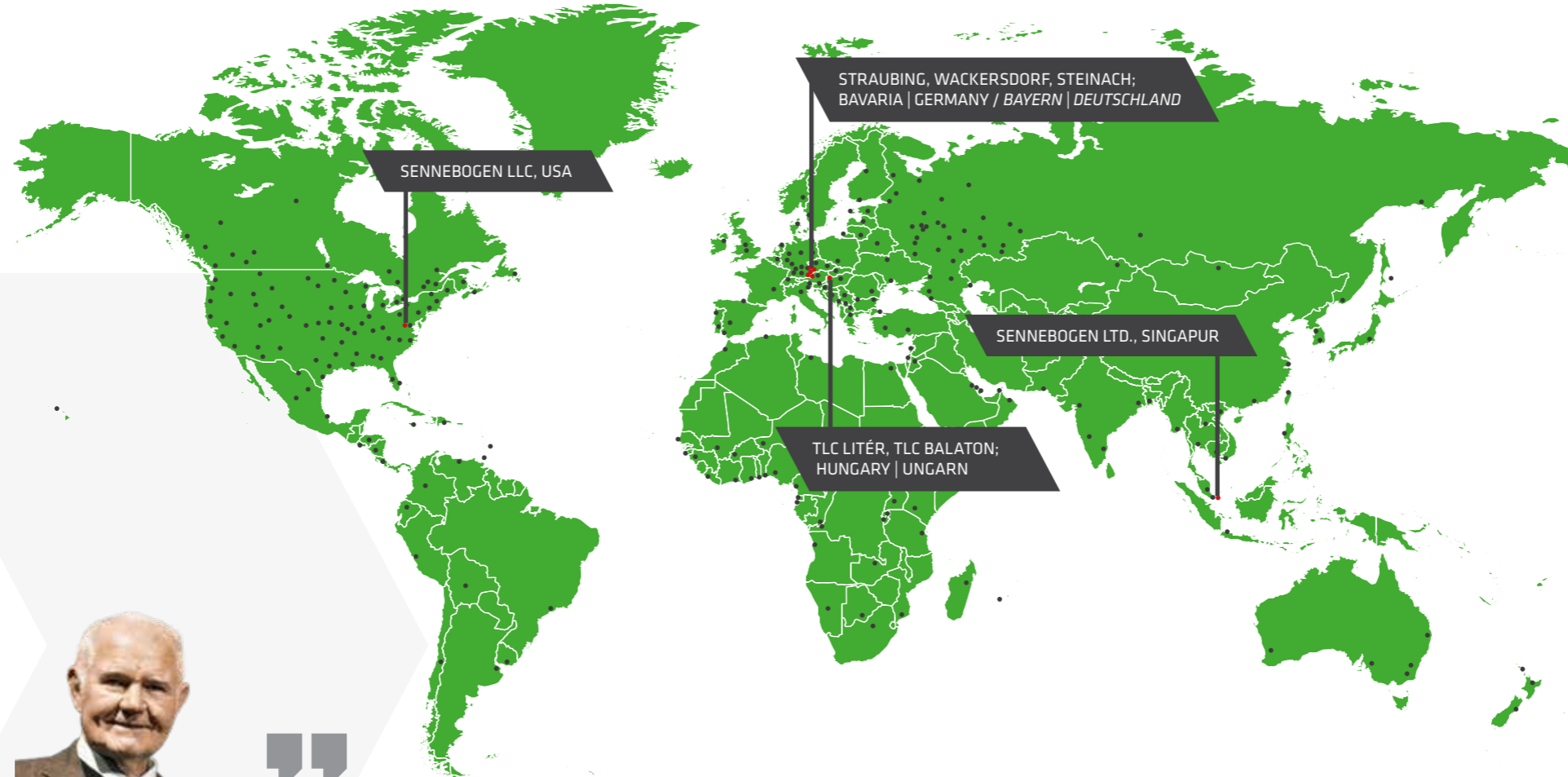

“
If you don't change anything,
you will not improve anything.

*Wer nichts verändert, der wird
auch nichts besser machen.*

Erich Sennebogen, 1931 - 2011
Founder / Unternehmensgründer

REPRESENTED WORLDWIDE WITH
OUR LOCATIONS AND SALES PARTNERS.

WELTWEIT VERTRETEN MIT UNSEREN
STANDORTEN UND VERTRIEBSPARTNERN.



What happens at a recycling site Was auf dem Recyclingplatz passiert

01 Delivery and unloading Anliefern und Entladen

Wood Recycling Facts Holzrecycling Fakten

8 mio. tons of used wood incur in Germany per year. So far only **33 %** are being recycled.

8 Mio. Tonnen Hölzabfälle fallen jährlich in Deutschland an. Lediglich **33 %** davon werden aktuell recycelt.



Material:
Waste wood
Material:
Altholz

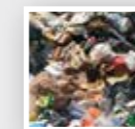

Material:
Waste
Material:
Abfälle

02 Piling and sorting Anhäufen und Sortieren

Waste Management Facts Abfallrecycling Fakten

60 % of the european waste has to be recycled by law until the year 2028. Germany has already reached a proportion of **over 70 %**.

60 % des europäischen Hausmülls müssen gesetzlich bis 2028 recycelt werden. Deutschland hat bereits eine Quote von **>70 %** erreicht.

04 Loading and stocking Verladen und Einlagern

Plastics Recycling Facts Kunststoff Recycling Fakten

82 % of the **4.5 mio. tons** of plastic waste produced in Germany are currently reused - with an upward trend.

82 % der insgesamt **4,5 Mio. Tonnen** Kunststoffabfälle in Deutschland werden aktuell verwertet, Tendenz steigend.



Material:
Plastics
Material:
Kunststoffe

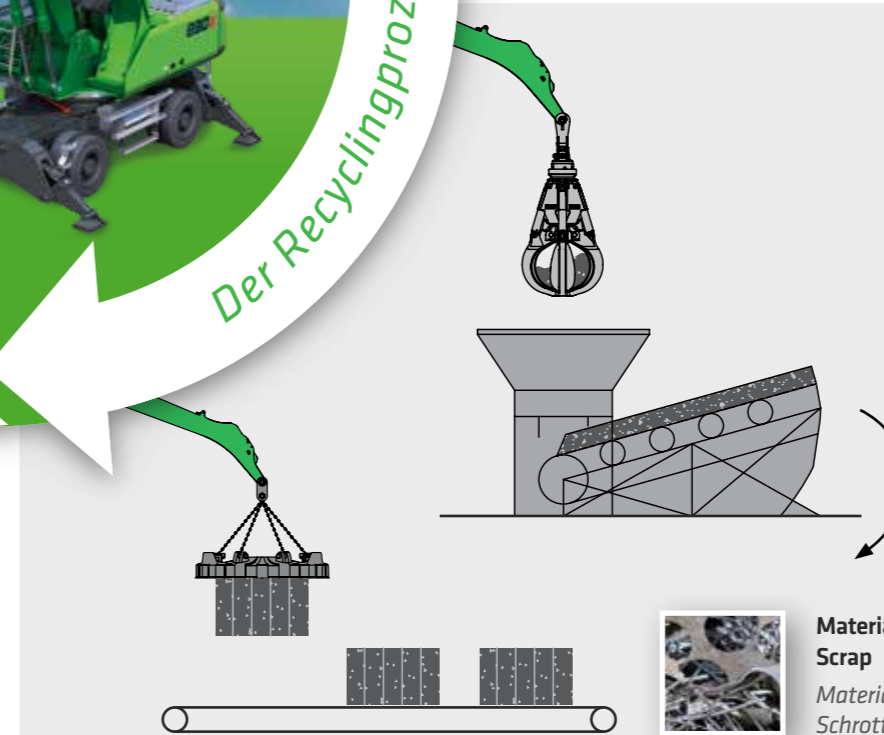

Material:
Scrap
Material:
Schrott

03 Processing and feeding Aufbereiten und Bestücken

Scrap Recycling Facts Schrottreycling Fakten

570 mio. tons of steel are recycled per year worldwide - that makes steel the recycling world champion.

570 Mio. Tonnen Stahl werden weltweit jährlich recycelt. Damit ist Stahl der Recycling-Weltmeister



More information about our grabs can be found on page 42/43. Mehr Informationen zu unserem Greifersortiment finden Sie auf Seite 42/43.

Well-equipped for recycling Bestens gerüstet für's Recycling

1



LED headlights for larger field of vision
LED Beleuchtung für größeres Sichtfeld

2

Reduced operating costs up to 50% through electric drive
Reduzierte Betriebskosten bis zu 50% durch Elektroantrieb

3

Clean coolers through automatic fan reversal
Saubere Kühler durch automatische Lüfterumkehr

4

Protection cover for hydraulic hoses
Schutzabdeckung für Hydraulikschläuche

5

Dustproof cylinder, through reverse mounting
Staubgeschützter Zylinder, dank umgedrehten Einbau

6



Optimal view from the elevating comfort cab Maxcab with sliding door*
*Optimale Sicht aus der hochfahrbaren Maxcab Komfortkabine mit Schiebetür**

7



Clean and safe working with blade*
*Sauberes und sicheres Arbeiten mit Schiebeschild**

8



Panorama view through cameras at right and rear
Rundumsicht durch Kameras nach rechts und hinten

9

Perfectly suited attachments (see page 42/43)
Perfekt abgestimmte Anbaugeräte (siehe Seite 42/43)



Electro: Reduce costs by 50%

Elektro: Kosten um 50% senken



6 benefits of electro-hydraulic drives

6 Vorteile elektrohydraulischer Antriebe

- **Increased comfort:** during operation with vibration-free drives and extremely low operating noise
 - **High value retention:** through longer service life of the hydraulic components
 - **Low operating costs:** thanks to low energy costs
 - **Longer extended maintenance intervals:** compared with diesel engines
 - **Reduced maintenance costs:** no need for fuel and oil filters / oil changes
 - **Always ready for use:** no fuelling and no fuel storage required
- Mehr Arbeitskomfort: durch vibrationsfreie Antriebe und sehr geräuscharmes Arbeiten
 - Hoher Werterhalt: durch die längere Lebensdauer der hydraulischen Komponenten
 - Niedrige Betriebskosten: dank geringer Energie- und Servicekosten
 - Längere Service-Intervalle: im Vergleich zum Dieselmotor
 - Geringe Servicekosten: durch Entfall von Kraftstoff- und Ölfilter / Ölwechsel
 - Immer einsatzbereit: da kein Betanken und keine Kraftstofflagerung erforderlich

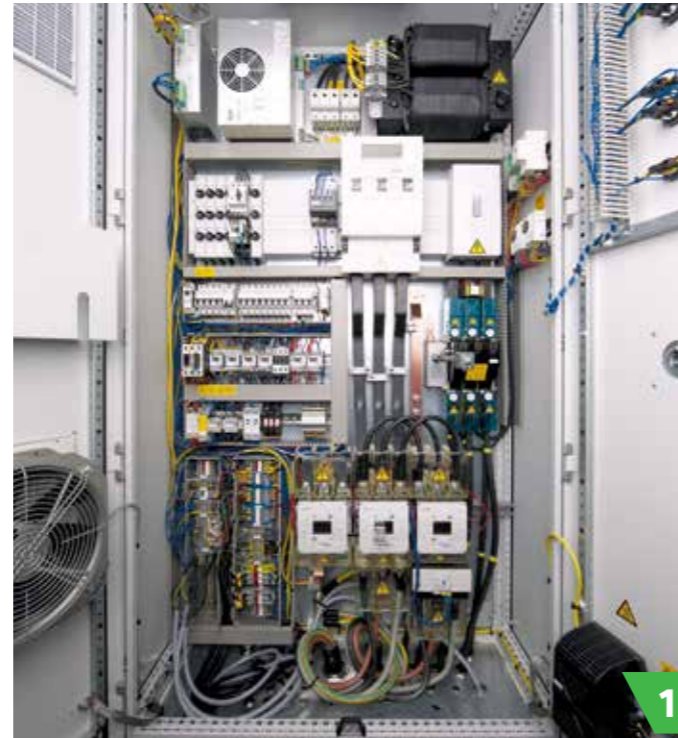

- 1** Clearly arranged electro components; standard components with high degree of availability
Übersichtlich angeordnete Elektrokompenten; Standard-Bauteile mit hoher Verfügbarkeit
- 2** Future-oriented electro-hydraulic drives: Economical, environmental-friendly and absolutely emission free
Zukunftsorientierte elektrohydraulische Antriebe: Sparsam, umweltfreundlich und absolut emissionsfrei

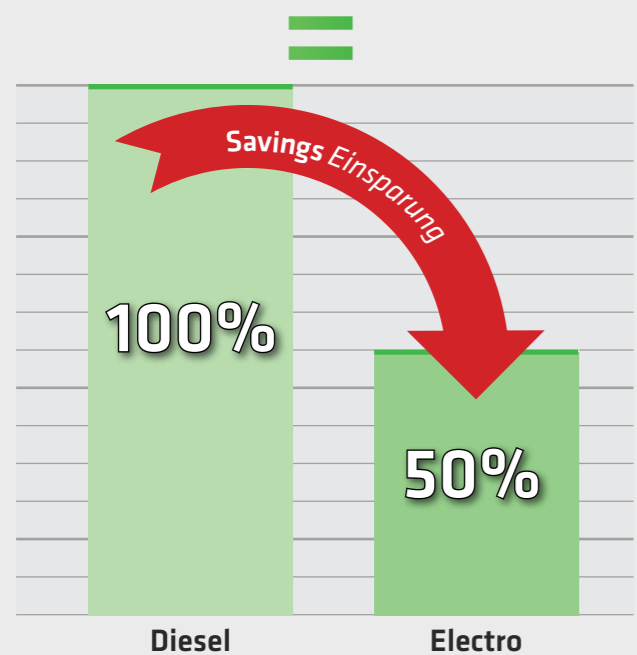

Electric Mobility – for every application

Elektrische Mobilität – für jede Applikation

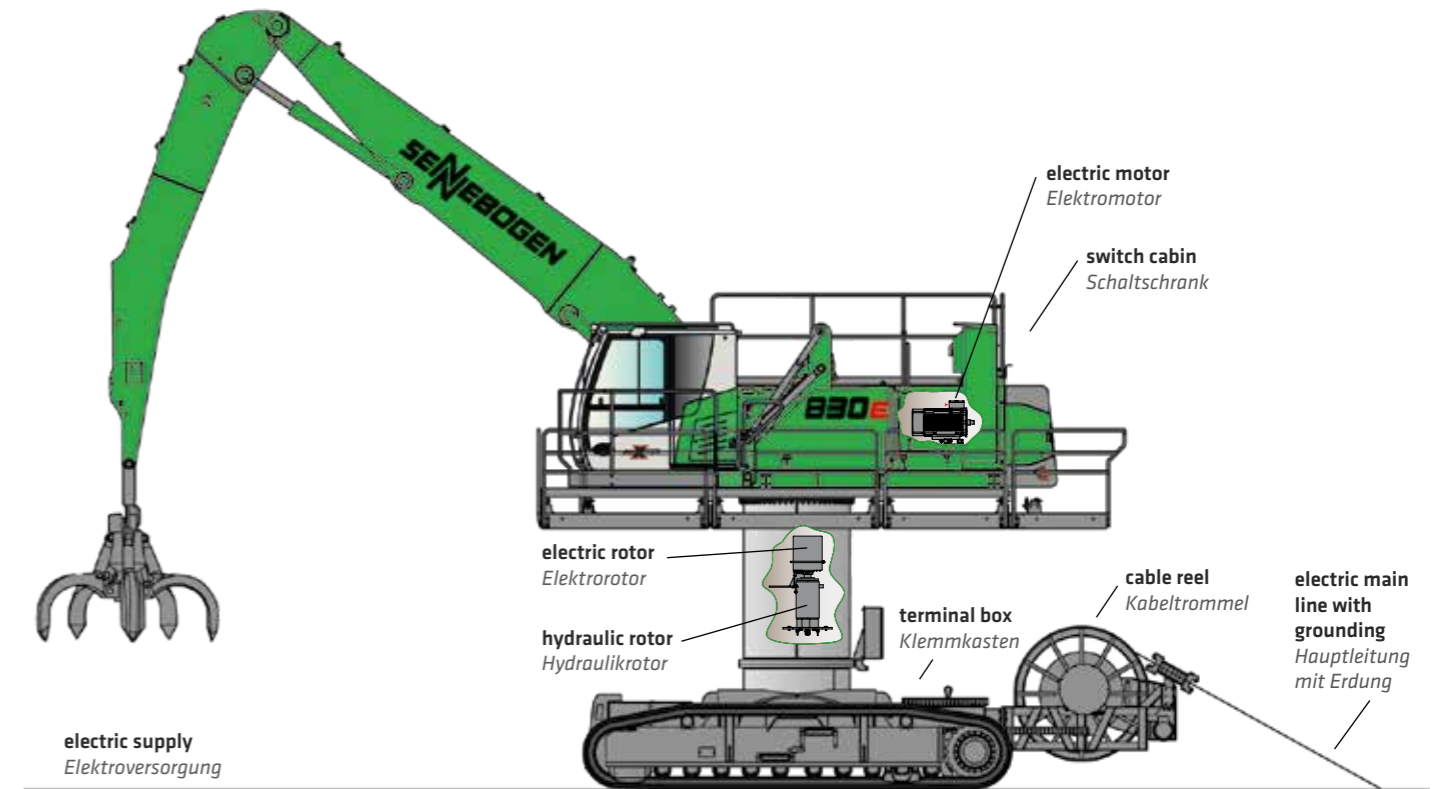

- Cylindrical reels for limited installation heights
■ Zylindrische Trommel für geringe Einbauhöhen
- Monospiral reel for linear travel paths
■ Spiralige Trommeln für lineare Verfahwege
- Powerpack solutions, for freely moving machines with electric drives
■ Powerpack-Lösungen für frei verfahrbare Maschinen mit Elektroantrieb

Modular design - versatile solutions

Modularer Aufbau - vielseitige Lösungen

AUSRÜSTUNGEN

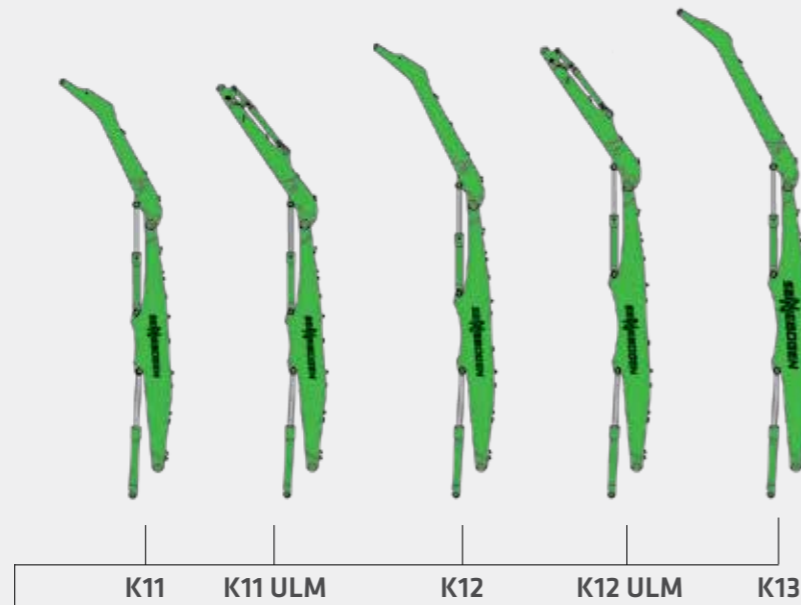

K = Kompaktausleger
 ULM = Ausrüstung mit Umlenkmechanismus, z. B. für Sortiergreifer

KABINE

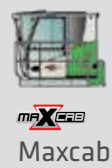

KABINENERHÖHUNG

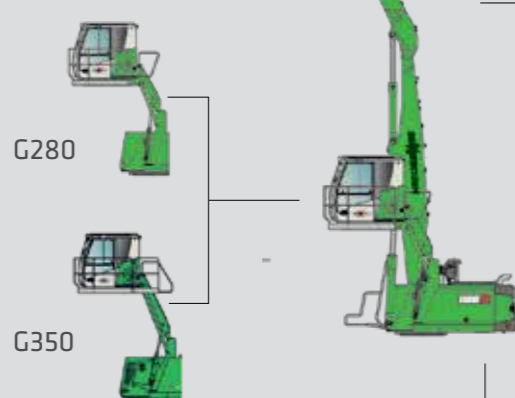

Diesel-hydraulischer Antrieb

UNTERWAGEN

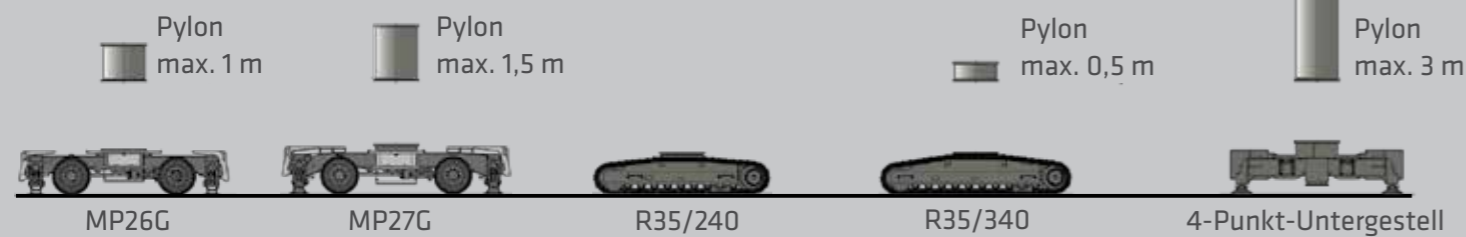

What will your machine be like?
 Wie sieht Ihre Maschine aus?













- Configure your individual machine with the use of our modular design. The wide range of solutions we are able to realise this way is unique all over the world.
- Konfigurieren Sie Ihre individuelle Maschine aus unserem modularen Baukastensystem. Die große Vielfalt an Lösungen, die wir auf diese Weise realisieren, ist weltweit einzigartig.

WATCH VIDEO
 VIDEO ANSEHEN



817E

Material Handling Machine Materialumschlagmaschine

-  **97 kW engine power***
Motorleistung*
-  **75 kW, 400 V, 50 Hz electro (alternative)**
Elektro (alternativ)
-  **17,2 t - 18,6 t operating weight**
Einsatzgewicht
-  **230 l fuel tank**
Kraftstofftankinhalt
-  **K8 / K8 ULM / K9 / K9 ULM equipment**
Ausrüstung
-  **2,9 t lift capacity at 8 m reach¹**
Traglast bei 8 m Reichweite¹
-  **300 l recommended sorting grab**
empfohlener Sortiergreifer
-  **190 l hydraulic tank**
Hydrauliktank
-  **1,96 m tail radius**
Heckradius
-  **2,54 m upper carriage width**
Oberwagenbreite
-  **0 - 8 rpm / 0 - 8 U/min¹ slewing speed**
Drehgeschwindigkeit
-  **5 m eye level**
Sichthöhe

¹ With mobile undercarriage in 5 m height / Bei Mobilunterwagen in 5 m Höhe

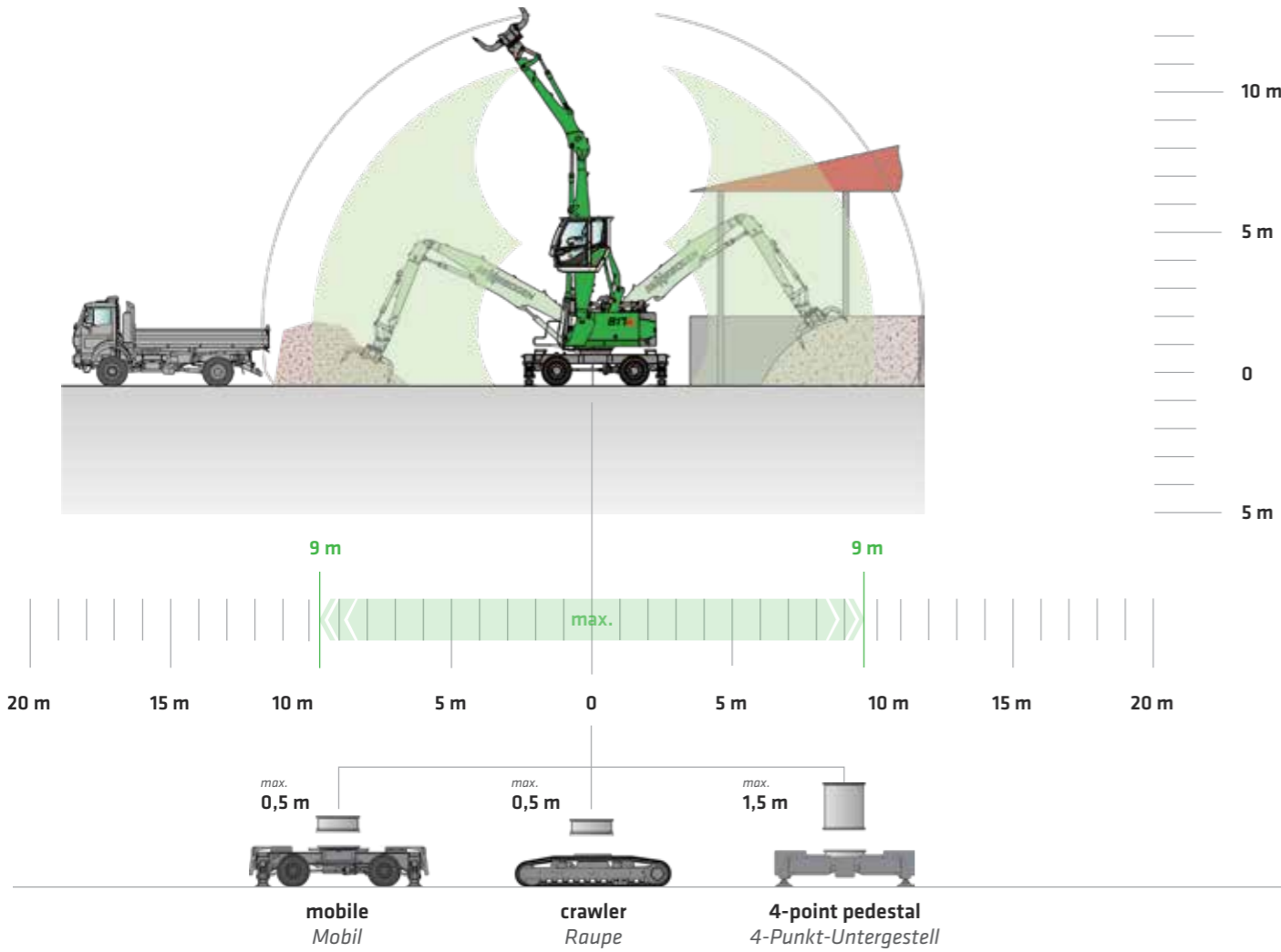

817 M - with sorting grab - loading of shredder; Germany
817 M - mit Sortiergreifer - Schredderbeladung; Deutschland



817 M - with sorting grab - loading of shredder indoor; Spitzbergen
817 M - Schredderbeladung in der Halle; Spitzbergen

16 * in accordance with emission standard Stage V. Other technical information can be found in the product brochure.
* gemäß Abgasstufe V. Weitere technische Informationen sind im technischen Prospekt zu finden.



817 M - with original SENNEBOGEN sorting grab - sorting works outdoor; Germany
817 M - mit original SENNEBOGEN Sortiergreifer- Sortiertätigkeiten im Freien; Deutschland



817 Electro - Efficient recycling and zero emissions thanks to stationary electrohydraulic drive; Germany
817 Elektro - effizientes Recycling und 0 Emissionen dank stationärer, elektrohydraulischer Lösung; Deutschland



817 M - loading of a truck at the ideal viewing height with SENNEBOGEN sorting grab; Germany
817 M - Beladung eines LKW auf idealer Sichthöhe mit SENNEBOGEN Sortiergreifer; Deutschland

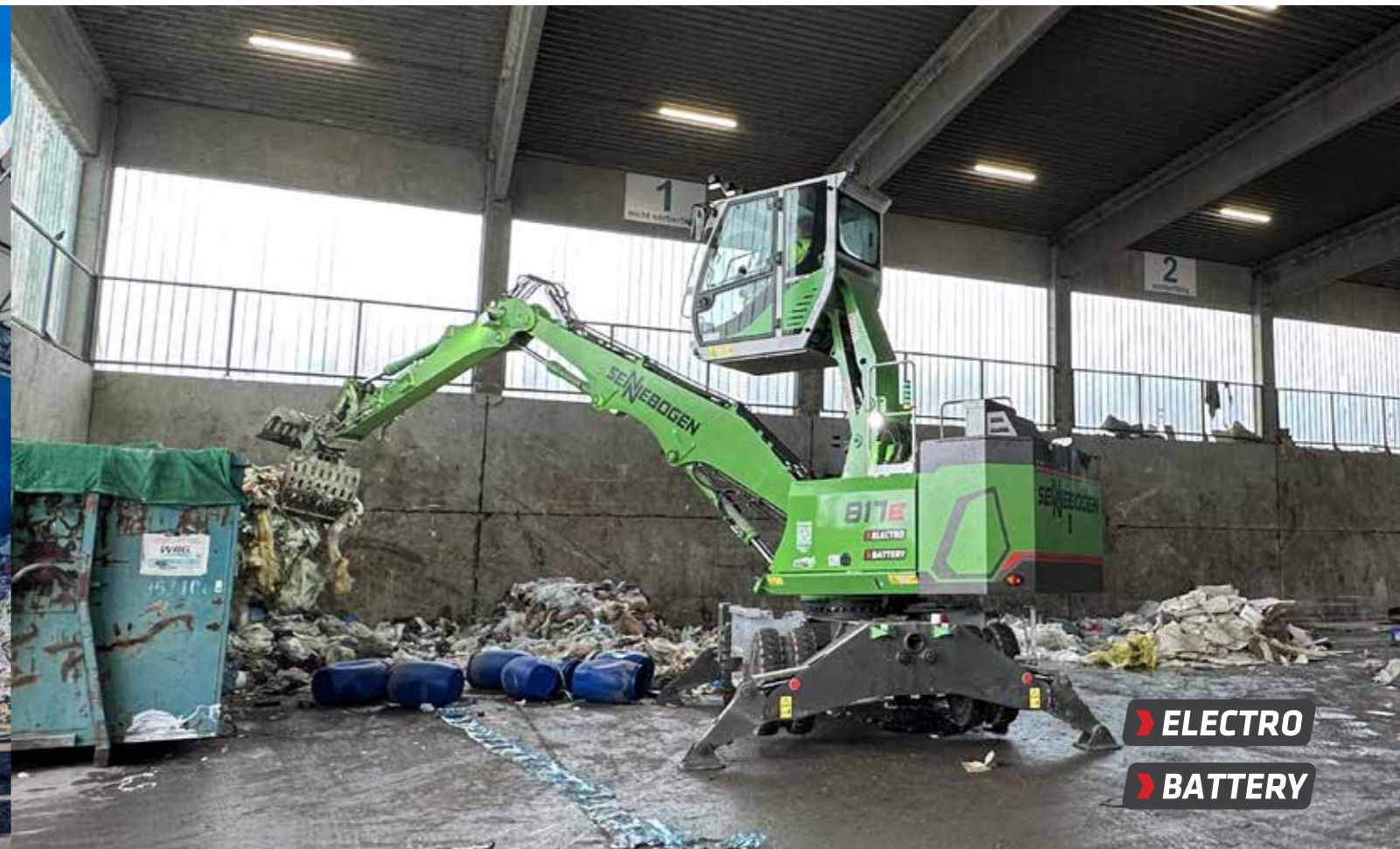

817 Electro Battery - with battery technology - sorting works indoor; Germany
817 Elektro Battery - mit Akku-Technologie - Sortiertätigkeiten in der Halle; Deutschland

ELECTRO
BATTERY



Material Handling Machine

Materialumschlagmaschine

*Vorgängermodell 818 E

- 110 kW**
engine power*
*Motorleistung**
- 22 t - 24,3 t**
operating weight
Einsatzgewicht
- 330 l**
fuel tank
Kraftstofftankinhalt
- K9 / K9 ULM / K10 / K10 ULM**
equipment
Ausrüstung
- 3,7 t**
lift capacity at 9 m reach¹
Traglast bei 9 m Reichweite¹
- 600 l**
recommended orange-peel grab
empfohlener Mehrschalengreifer
- 220 l**
hydraulic tank
Hydrauliktank
- 2,39 m**
tail radius
Heckradius
- 2,54 m**
upper carriage width
Oberwagenbreite
- 0 - 8 rpm / 0 - 8 U/min¹**
slewing speed
Drehgeschwindigkeit
- 2,9 m - 7 m**
eye level
Sichthöhe

¹ With mobile undercarriage in 6 m height / Bei Mobilunterwagen in 6 m Höhe

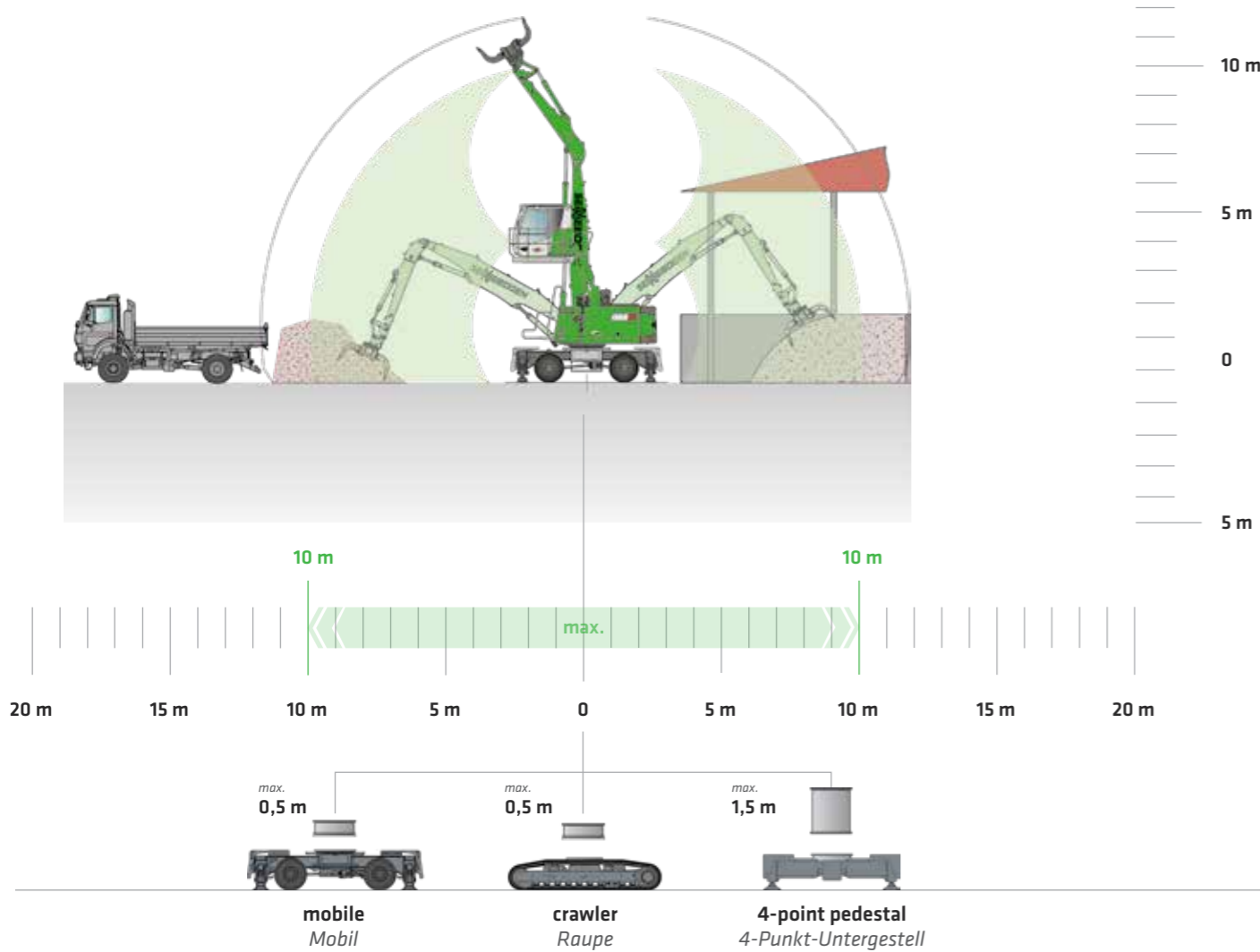

822 M - with sorting grab - sorting of waste; Germany
822 M - mit Sortiergreifer - Sortierung von Abfall; Deutschland



822 M - with sorting grab - loading of a truck with used tires; Austria
822 M - mit Sortiergreifer - LKW-Beladung mit Altreifen; Österreich

20 * in accordance with emission standard Stage V. Other technical information can be found in the product brochure.
* gemäß Abgasstufe V. Weitere technische Informationen sind im technischen Prospekt zu finden.



822 M - loading of container outdoor; Austria
 822 M - Container Beladung im Freien; Österreich



822 M - sorting of aluminum bundles with sorting grab and quick change grab; Germany
 822 M - Sortierung von Aluminiumballen mit Sortiergreifer und Schnellwechsler; Deutschland



822 M - with sorting grab - sorting of timber; Germany
 822 M - mit Sortiergreifer - Sortieren von Holz; Deutschland



818 R Electro- with sorting grab - handling of waste wood; Norway
 818 R Elektro - mit Sortiergreifer - Materialumschlag Altholz; Norwegen



818 M Elektro – with sorting grab – loading of shredder indoor - machine with powerpack solution; Germany
 818 M Elektro – mit Sortiergreifer – Schredderbelandung in der Halle - Maschine mit Powerpack-Lösung; Deutschland



818 M - wood processing on a recycling site; UK
 818 M - Holzverarbeitung in einer Recycling-Anlage; Großbritannien



818 M Electro – with original SENNEBOGEN orange peel grab – feeding of a baling press; Germany
 818 M Elektro – mit original SENNEBOGEN Mehrschalengreifer – Beschickung der Ballenpresse; Deutschland

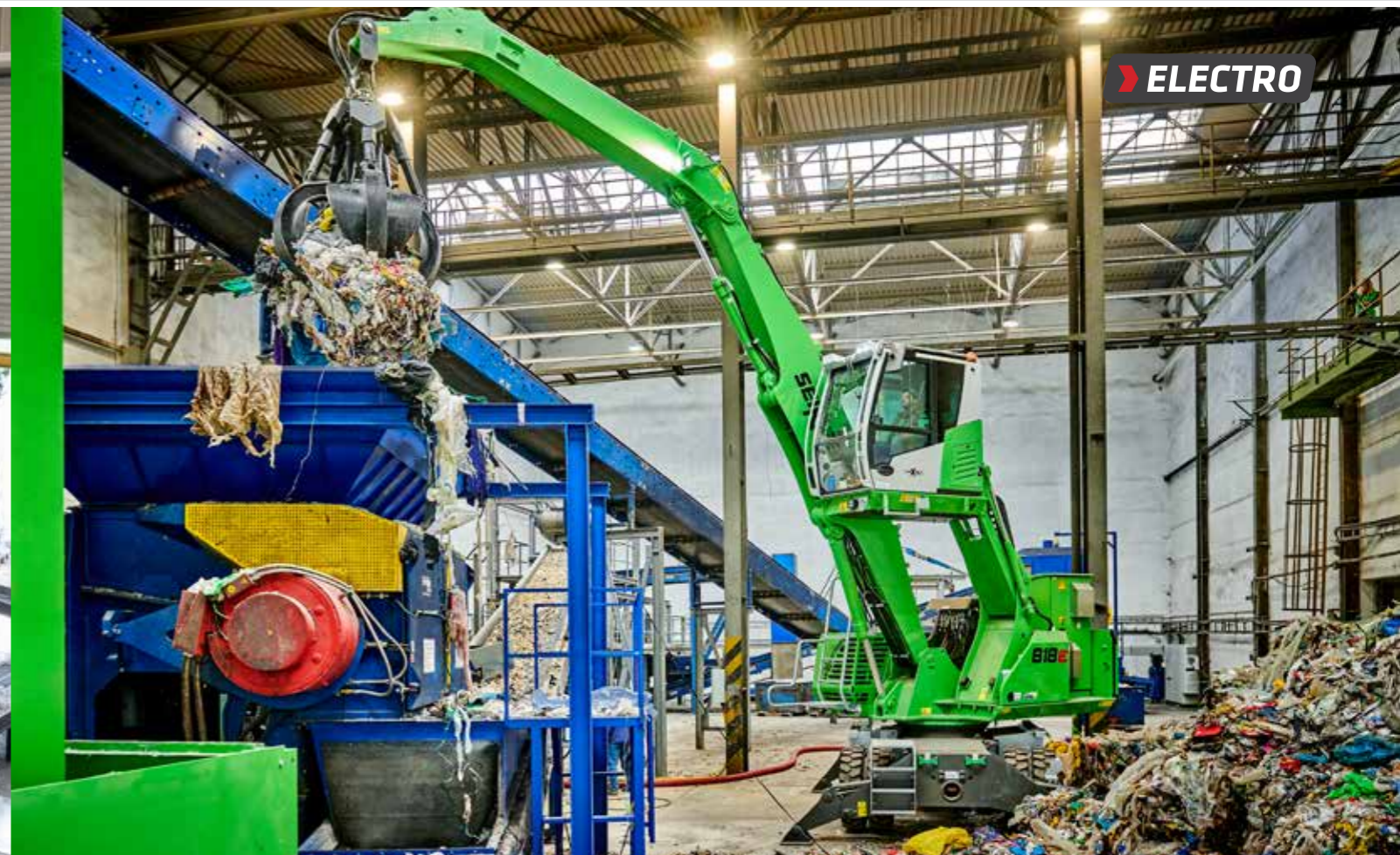











818 M Electro – with orange peel grab, feeding a shredding unit for thermoplastics; Czech Republic
 818 M Elektro – mit Mehrschalengreifer, Beschicken einer Thermoplastik-Zerkleinerungsanlage; Tschechien



Material Handling Machine

Materialumschlagmaschine

*Vorgängermodell 821 E

-  **118 kW**
engine power*
*Motorleistung**
-  **24 t - 26,3 t**
operating weight
Einsatzgewicht
-  **330 l**
fuel tank
Kraftstofftankinhalt
-  **K9 / K10 / K10 ULM / K11 / K11 ULM / K12**
equipment
Ausrüstung
-  **4,0 t**
lift capacity at 10,5 m reach¹
Traglast bei 10,5 m Reichweite¹
-  **600 l**
recommended orange peel grab
empfohlener Mehrschalengreifer
-  **240 l**
hydraulic tank
Hydrauliktank
-  **2,49 m**
tail radius
Heckradius
-  **2,54 m**
upper carriage width
Oberwagenbreite
-  **0 - 8 rpm / 0 - 8 U/min⁻¹**
slewing speed
Drehgeschwindigkeit
-  **2,9 m - 8,6 m**
eye level
Sichthöhe

¹ With mobile undercarriage in 6 m height / Bei Mobilunterwagen in 6 m Höhe

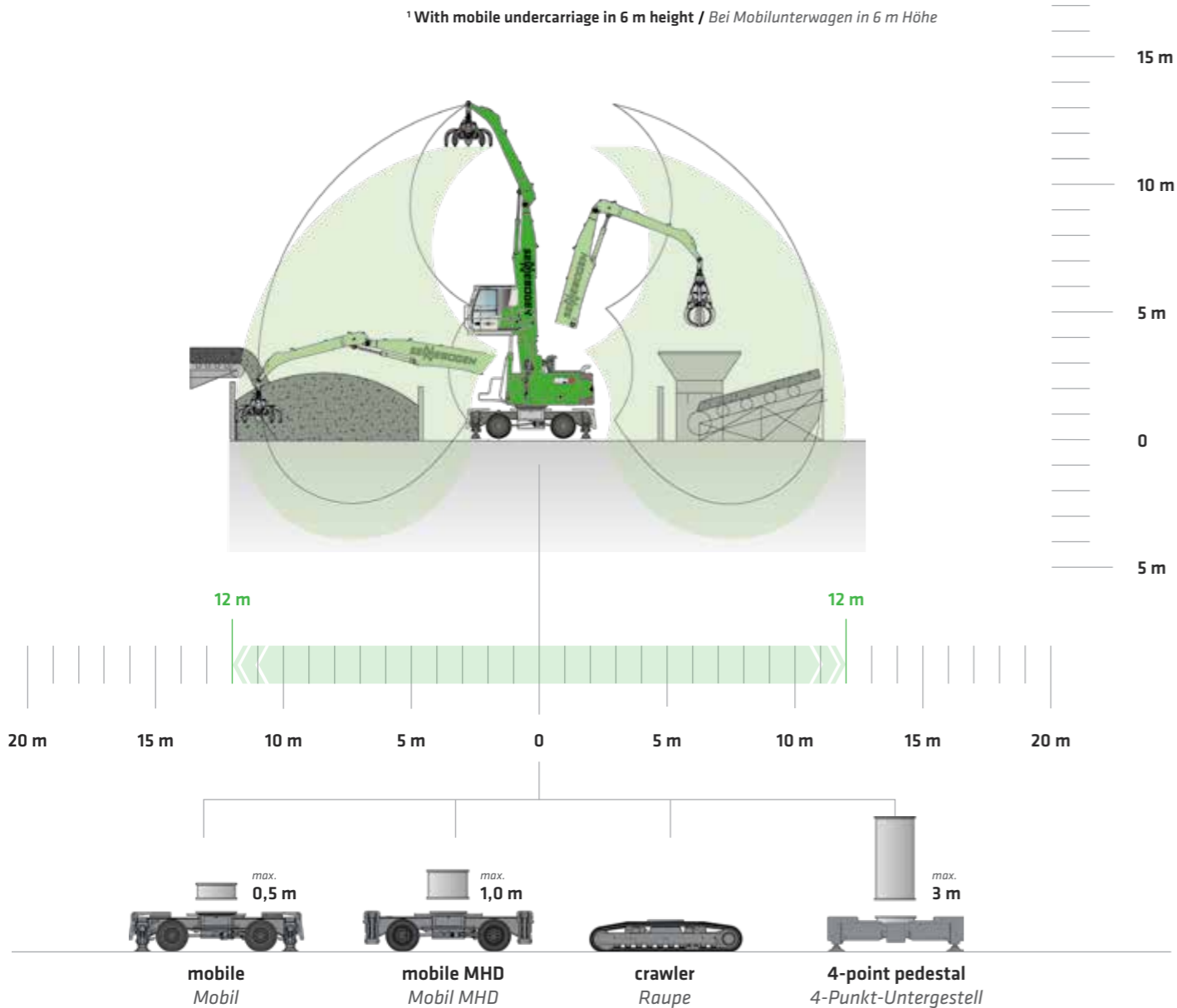

824 M - with orange peel grab - scrap handling; Germany
824 M - mit Mehrschalengreifer - Schrottschlag; Deutschland



824 M - with sorting grab - sorting of waste wood; Switzerland
824 M - mit Sortiergreifer - Sortieren von Altholz; Schweiz

26 * in accordance with emission standard Stage V. Other technical information can be found in the product brochure.

* gemäß Abgasstufe V. Weitere technische Informationen sind im technischen Prospekt zu finden.

ELECTRO



821 R Electro - with sorting grab - bulky waste; Netherlands
821 R Elektro - mit Sortiergreifer - Sperrmüllsortierung; Niederlande



821 M - with 4 t scrap shear - shredding of scrap; France
821 M - mit 4 t Schrottschere - Zerkleinern von Schrott; Frankreich

ELECTRO



821 M Electro - with orange peel grab - feeding a shredder - powerpack; Germany
821 M Elektro - mit Mehrschalengreifer - Shredderbeschickung - Powerpack; Deutschland













821 M - with sorting grab - sorting of waste, indoor; Netherlands
821 M - mit Sortiergreifer - Sortieren von Abfall in der Halle; Niederlande



Material Handling Machine

Materialumschlagmaschine

-  **129 kW**
engine power*
*Motorleistung**
-  **K11 / K11 ULM / K12 / K12 ULM / K13**
equipment
Ausrüstung
-  **2,49 m**
tail radius
Heckradius
-  **26 t**
operating weight
Einsatzgewicht
-  **4,4 t**
lift capacity at 10,5 m reach¹
Traglast bei 10,5 m Reichweite¹
-  **2,54 m**
upper carriage width
Oberwagenbreite
-  **330 l**
fuel tank
Kraftstofftankinhalt
-  **600 l**
recommended orange peel grab
empfohlener Mehrschalengreifer
-  **0 - 8 rpm / 0 - 8 U/min¹**
slewing speed
Drehgeschwindigkeit
-  **240 l**
hydraulic tank
Hydrauliktank
-  **2,9 m - 8,6 m**
eye level
Sichthöhe

¹ With mobile undercarriage in 6 m height / Bei Mobilunterwagen in 6 m Höhe

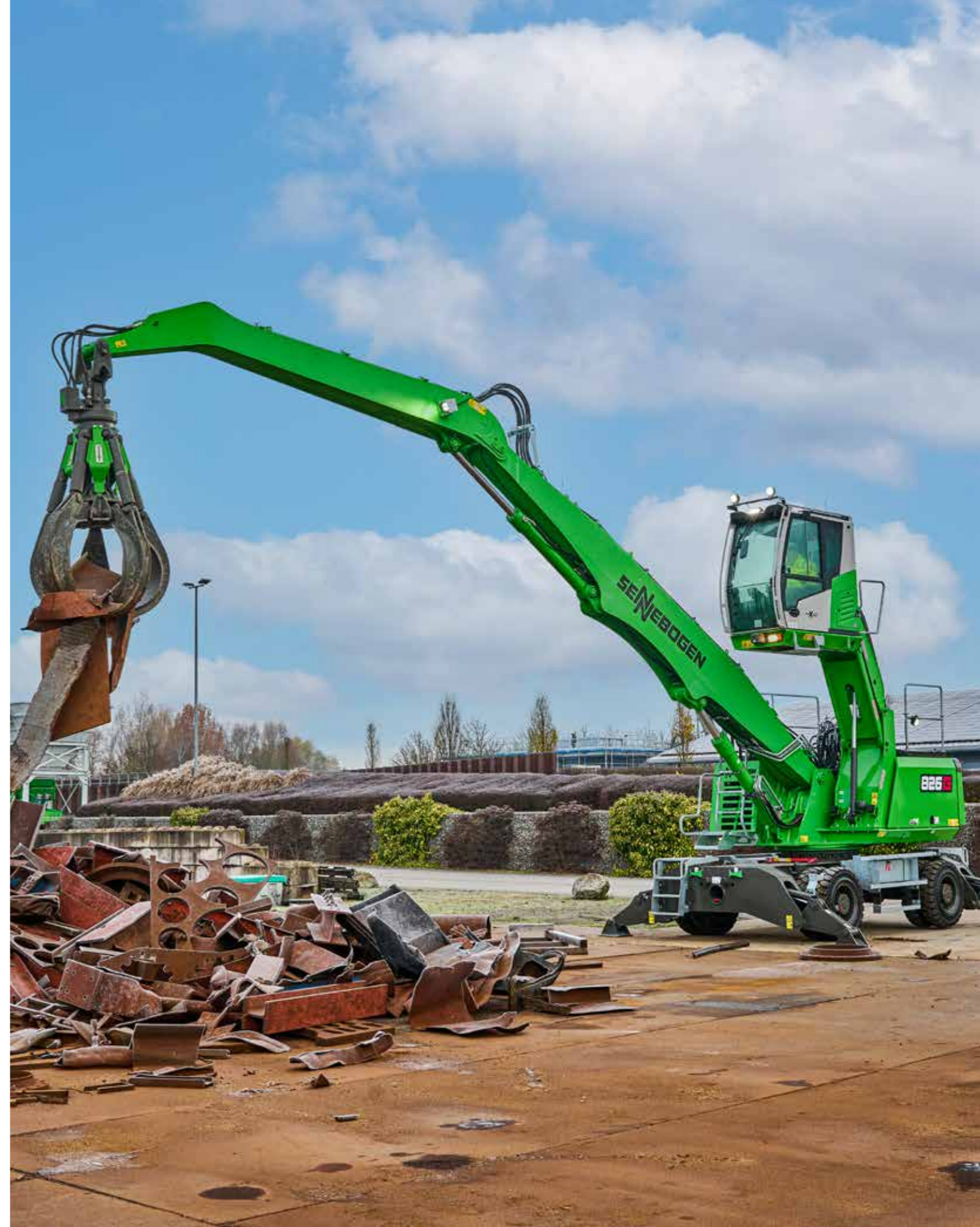
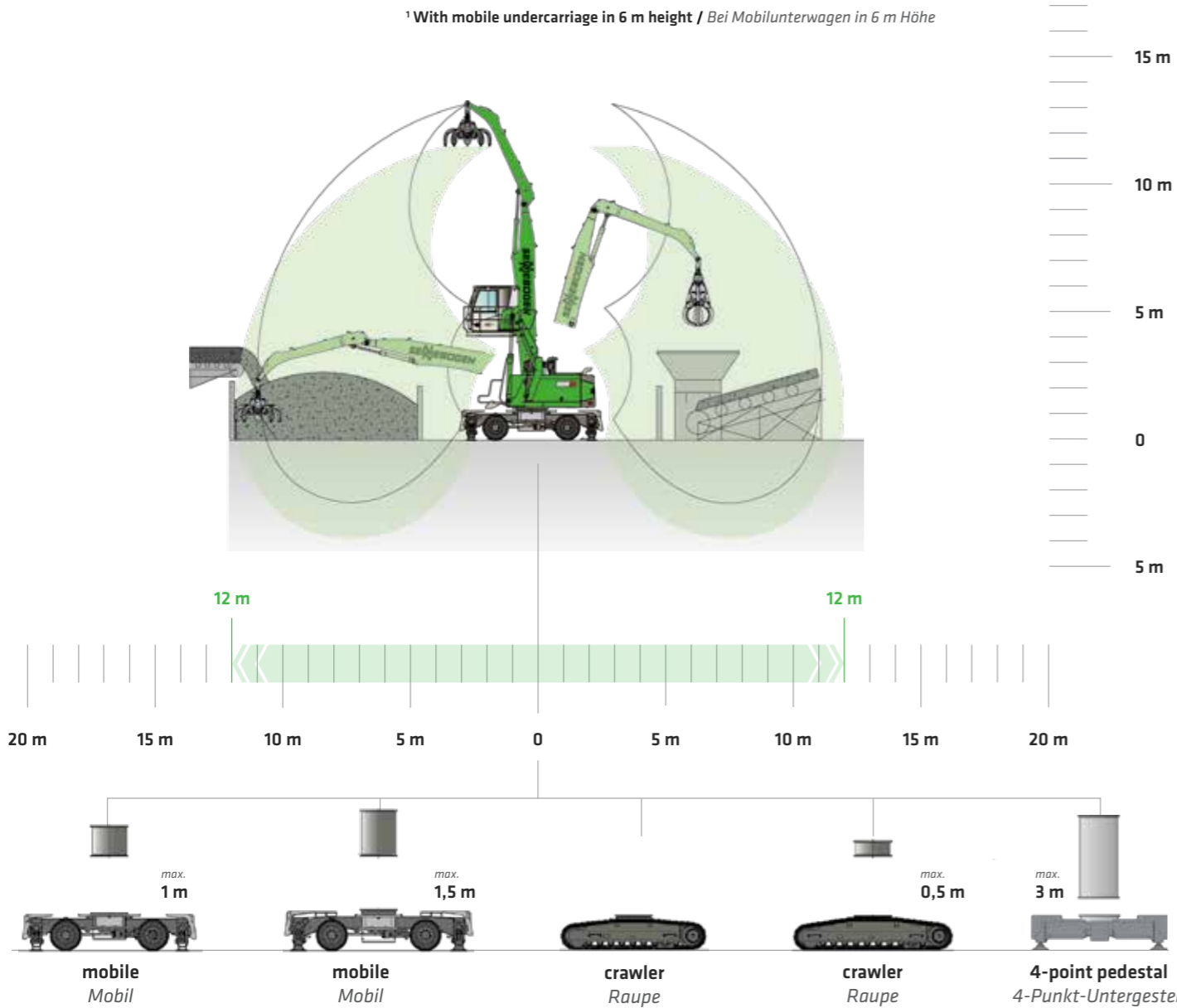











30 * in accordance with emission standard Stage V. Other technical information can be found in the product brochure.
* gemäß Abgasstufe V. Weitere technische Informationen sind im technischen Prospekt zu finden.

826 M - with orange peel grab - sorting scrap; Germany
826 M - mit Mehrschalengreifer - Schrottsortierung; Deutschland

825E Material Handling Machine

Materialumschlagmaschine

-  **129 kW engine power***
Motorleistung*
-  **110 kW, 400 V, 50 Hz electro**
Elektro
-  **ca. 28,8 t operating weight**
Einsatzgewicht
-  **450 l fuel tank**
Kraftstofftankinhalt
-  **K12 / K12 ULM / K13 / K14 equipment**
Ausrüstung
-  **4,2 t lift capacity at 12 m reach¹**
Traglast bei 12 m Reichweite¹
-  **600 l recommended orange peel grab**
empfohlener Mehrschalengreifer
-  **310 l hydraulic tank**
Hydrauliktank
-  **2,75 m tail radius**
Heckradius
-  **2,75 m upper carriage width**
Oberwagenbreite
-  **0 - 8 rpm / 0 - 8 U/min⁻¹ slewing speed**
Drehgeschwindigkeit
-  **2,9 m - 8,7 m eye level**
Sichthöhe

¹ With mobile undercarriage in 4,5 m height / Bei Mobilunterwagen in 4,5 m Höhe

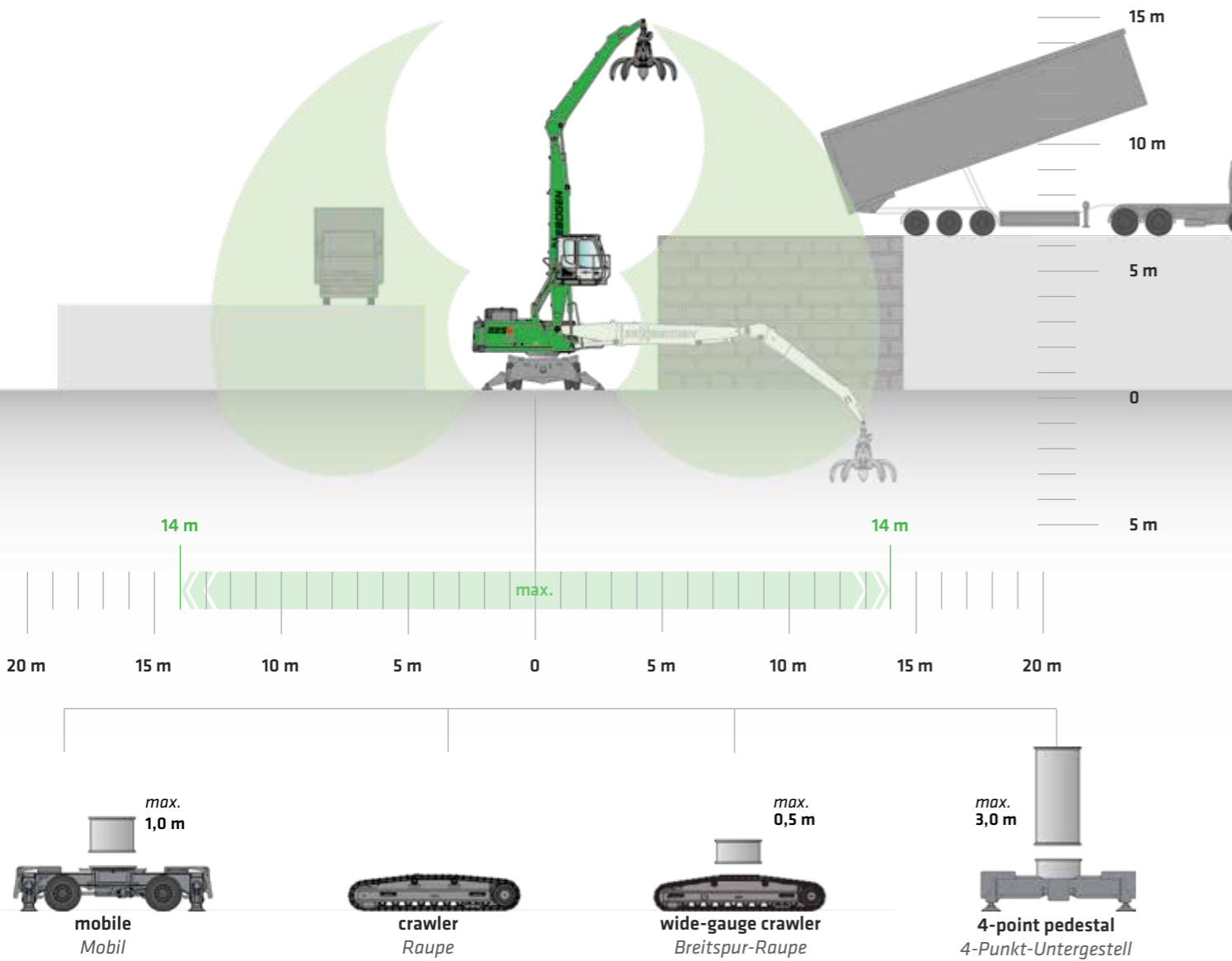

825 M - with orange peel grab - truck loading with used paper; Germany
825 M - mit Mehrschalengreifer - LKW Beladung mit Altpapier; Deutschland



ELECTRO

BATTERY

825 Electro Battery - with battery technology - sorting scrap - Handling aluminum; Sweden
825 Electro Battery - mit Akku-Technologie - Schrottsortierung - Alu-Umschlag; Schweden

32 * in accordance with emission standard Stage V. Further technical information can be found in the product brochure.
* gemäß Abgasstufe V. Weitere technische Informationen sind im technischen Prospekt zu finden.



825 M – vario tool with scrap shear and orange peel grab – scrap handling; Hungary
 825 M – Vario Tool mit Schrottschere und Mehrschalengreifer – Schrottschlag; Ungarn



ELECTRO

825 M Electro – with orange peel grab – scrap recycling indoor with ceiling power supply; Germany
 825 M Elektro – mit Mehrschalengreifer – Schrottschlag im Halleneinsatz mit Deckenstromzuführung; Deutschland



ELECTRO













825 stationary Electro – with orange peel grab – feeding a scrap shear; Hungary
 825 stationär Elektro – mit Mehrschalengreifer – Beschickung einer Schrottschere; Ungarn



825 M – scrap handling with magnet; Germany
 825 M – Schrottschlag mit Magnet; Deutschland

830E

Material Handling Machine Materialumschlagmaschine

-  **168 kW engine power***
Motorleistung*
-  **132 kW, 400 V, 50 Hz electro (alternative 1)**
Elektro (alternativ 1)
-  **160 kW, 400 V, 50 Hz electro (alternative 2)**
Elektro (alternativ 2)
-  **38,5 t - 56 t operating weight**
Einsatzgewicht
-  **500 l fuel tank**
Kraftstofftankinhalt
-  **K15 / K17 / B16 / K14 / K14 ULM / K13 VT equipment**
Ausrüstung
-  **3,6 t lift capacity at 17 m reach¹**
Traglast bei 17 m Reichweite¹
-  **600 - 800 l recommended orange peel grab**
empfohlener Mehrschalengreifer
-  **310 l hydraulic tank**
Hydrauliktank
-  **3,10 m tail radius**
Heckradius
-  **2,75 m upper carriage width**
Oberwagenbreite
-  **0 - 8 rpm / 0 - 8 U/min¹ swing speed**
Drehgeschwindigkeit
-  **3,1 m - 10,1 m eye level**
Sichthöhe

¹With mobile undercarriage in 4,5 m height / Bei Mobilunterwagen in 4,5 m Höhe

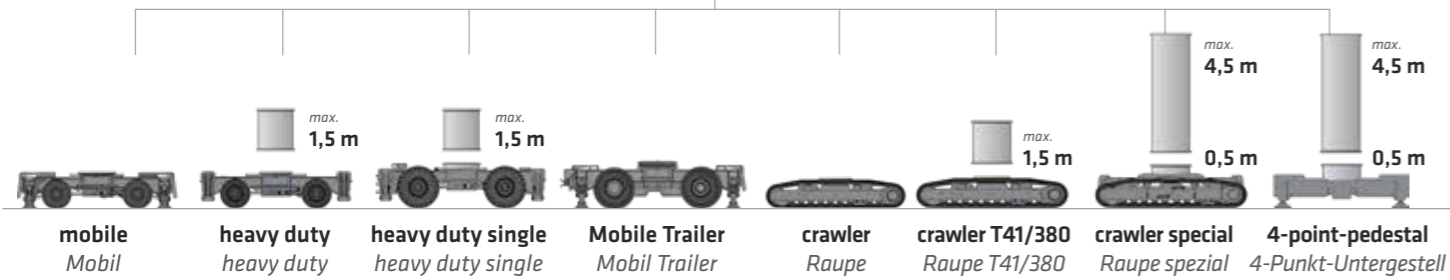
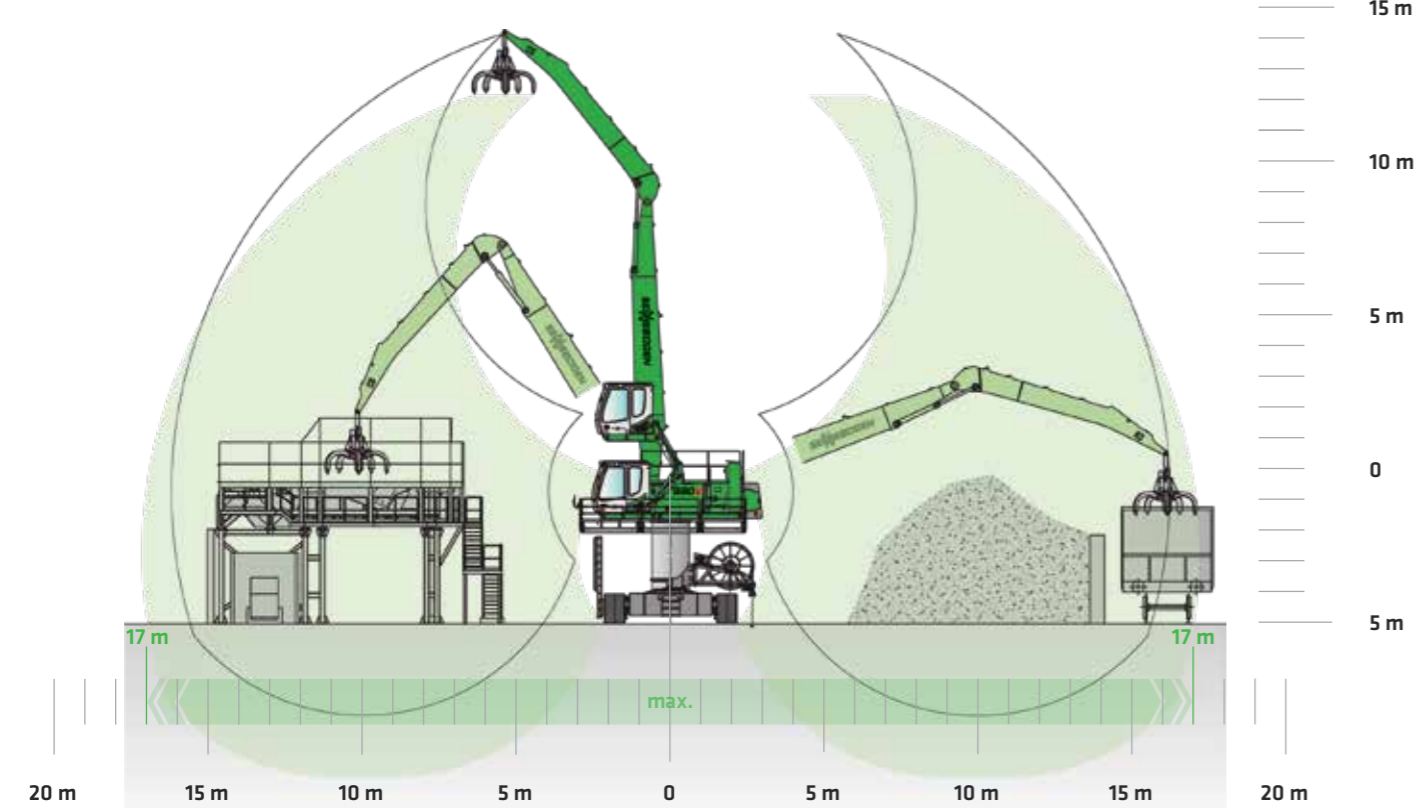

ELECTRO



830 R Electro - with orange peel grab - scrap handling; Japan
830 R Elektro - mit Mehrschalengreifer - Schrottschlag; Japan

ELECTRO



830 M Electro - with orange peel grab - loading of steel bales; Great Britain
830 M Elektro - mit Mehrschalengreifer - Verladung von Stahlballen; Großbritannien

36 * in accordance with emission standard Stage V. Stage IIIa and other technical information can be found in the product brochure.
* gemäß Abgasstufe V. Stufe IIIa-Werte und andere technische Informationen sind im technischen Prospekt zu finden.



830 M Vario Tool - with 4 t scrap shear - shearing of scrap; Great Britain
830 M Vario Tool - mit 4 t Schrottschere - Zerkleinern von Schrott; Großbritannien



830 M - with orange peel grab - scrap handling; Germany
830 M - mit Mehrschalengreifer - Schrottschlag; Deutschland















830 M - with orange peel grab - scrap recycling; UK
830 M - mit Mehrschalengreifer - Schrottreycling; UK



830 R Electro - with orange peel grab - scrap recycling; Switzerland
830 R Elektro - mit Mehrschalengreifer - Schrottreycling; Schweiz

340 G

Telehandler Teleskoplader

-  **100 kW**
engine power
Motorleistung
-  **0 - 40 km/h**
travel speed
Fahrgeschwindigkeit
-  **9,4 t**
operating weight
Einsatzgewicht
-  **160 l**
fuel tank
Kraftstofftankinhalt
-  **7,7 m**
lifting height
Hubhöhe
-  **4 t**
lift capacity
Traglast
-  **1,1 m³ - 3,0 m³**
recommended bucket size
empfohlene Schaufelgröße
-  **140 l**
hydraulic tank
Hydrauliktank
-  **2,5 m**
transport height
Transporthöhe
-  **2,5 m**
transport width
Transportbreite
-  **3,1 m**
wheel base
Radstand
-  **4,1 m**
eye level
Sichthöhe



340 G Telehandler - loading of a container with used paper; Germany
340 G Teleskoplader - Container-Beladung mit Altpapier; Deutschland















340 G Telehandler - loading of a truck with used paper; Germany
340 G Teleskoplader - LKW-Beladung mit Altpapier; Deutschland



340 G Telehandler - Biocycling; Germany
340 G Teleskoplader - Biocycling; Deutschland

355 E Telehandler Teleskoplader

-  **123 kW**
engine power
Motorleistung
-  **0 - 40 km/h**
travel speed
Fahrtgeschwindigkeit
-  **11,8 t**
operating weight
Einsatzgewicht
-  **200 l**
fuel tank
Kraftstofftankinhalt
-  **8,5 m**
lifting height
Hubhöhe
-  **5,5 t**
lift capacity
Traglast
-  **1,6 m³ - 5,0 m³**
recommended bucket size
empfohlene Schaufelgröße
-  **120 l**
hydraulic tank
Hydrauliktank
-  **2,7 m**
transport height
Transporthöhe
-  **2,5 m**
transport width
Transportbreite
-  **3,25 m**
wheel base
Radstand
-  **4,25 m**
eye level
Sichthöhe



355 E Telehandler - handling used tires with bucket; Netherlands
355 E Teleskoplader - Umschlag von Altreifen mit Schaufel; Niederlande



355 E Telehandler - truck loading with bucket - ideal overview with elevating cab; Germany
355 E Teleskoplader - LKW Beladung mit Schaufel - beste Übersicht dank hochfahrbarer Kabine; Deutschland



355 E Telehandler - handling of waste wood with bucket; Germany
355 E Teleskoplader - Materialumschlag von Altholz; Deutschland



355 E Telehandler - truck unloading of waste paper bundles; Hungary
355 E Teleskoplader - LKW-Entladung von Altpapierballen; Ungarn



355 E Telehandler - feeding a shredder with bark mulch; Germany
355 E Teleskoplader - Schredderbeschickung mit Rindenmulch; Deutschland



355 E Telehandler - powerful engine under dusty conditions thanks to standard reversible fan; Hungary
355 E Teleskoplader - Leistungsstarker Motor auch bei staubigen Umgebungen dank serienmäßigen Umkehrlüfter; Ungarn

Warranty Programs Gewährleistung

Basic Warranty / Grund-Gewährleistung*

➤ The Basic Warranty is valid for the first 12 months or max. 2000 operating hours from the date of commissioning and applies to either Parts or a Full Warranty including labour and travel costs.

Die Grund-Gewährleistung gilt in den ersten 12 Monaten bzw. max. 2000 Betriebsstunden ab Inbetriebnahme auf Teile oder im Rahmen einer Vollgewährleistung inkl. Arbeits- und Fahrtkosten.

Extended Warranty / Erweiterte Gewährleistung*

➤ Also from month 13 / operating hour 2001 you can choose from different exclusive packages depending on your wishes and the scope of warranty:

Auch ab dem 13. Monat / ab der 2001. Betriebsstunde wählen Sie je nach Wunsch und Gewährleistungsumfang aus unterschiedlichen Exklusiv-Paketen:

-  **Platinum Package**
-  **Gold Package**
-  **Silver Package**
-  **Bronze Package**

Spare-Parts Warranty / Ersatzteil-Gewährleistung*

➤ SENNEBOGEN grants a warranty on brand-new, original SENNEBOGEN spare parts from installation or respectively for 12 months or up to a maximum of 2000 operating hours in the first 18 months after delivery.

Auf fabrikneue, original SENNEBOGEN Ersatzteile gewährt SENNEBOGEN ab Einbau bzw. 12 Monate lang oder bis max. 2000 Betriebsstunden im Zeitraum der ersten 18 Monate ab Auslieferung eine Gewährleistung.



For every job the right tool Für jeden Einsatz das richtige Werkzeug

Sorting grab / Sortiergreifer



- » **With metal ribs or perforated skin available**
Mit Siebrippen oder Lochrückwand lieferbar
- » **Minor height, lower weight**
Geringe Bauhöhe, niedriges Gewicht
- » **Optimized for SENNEBOGEN**
Optimiert für SENNEBOGEN
- » **Grab capacity 300 l - 520 l**
Greiferinhalt 380 l - 520 l

Further information is available in our special grab brochure

Weitere Informationen finden Sie in unserem speziellem Greiferprospekt



Orange peel grab (4 shells) / Mehrschalengreifer (4 Schalen)



- » **Simple and clear dipping into containers or other repositories**
Einfaches und sauberes Eintauchen in Container oder andere Behälter
- » **Safe grab closure with bulky goods, e.g. bars, autobodies**
Sicherer Greifschluss bei sperrigen Materialien, z.B. Langmaterial, Autokarosserien
- » **Grab capacity 500 l - 2000 l**
Greiferinhalt 500 l - 2000 l

- » **Less weight than with 5 shells, allows approx. 13% more payload!**
Weniger Greifergewicht als mit 5 Schalen, ermöglicht ca. 13% mehr Nutzlast!

Orange peel grab (5 shells) / Mehrschalengreifer (5 Schalen)



- » **Cast steel crosshead, shells of SGM.40 made of cast steel**
Stahlgussstraverse, Schalen von SGM.40 gegossen
- » **Endless rotation up to 18 rpm**
Endlos Drehantrieb bis 18 min⁻¹
- » **External drive motor for easy maintenance**
Externer Antriebsmotor für einfache Wartung
- » **Grab capacity 500 l - 8000 l**
Greiferinhalt 500 l - 8000 l

Shell profiles / Schalenformen



- » **Half opened shell**
Halboffene Schale

- » **Closed shell**
Geschlossene Schale

- » **Further shell profiles on inquiry**
Weitere Schalenformen auf Anfrage



Loading hook / Lasthaken



- » **Free rotatable loading hook**
Frei drehender Lasthaken

- » **Hydraulically rotatable loading hook***
*Hydraulisch drehbarer Lasthaken**



Quick change device Variolock / Schnellwechselsystem Variolock

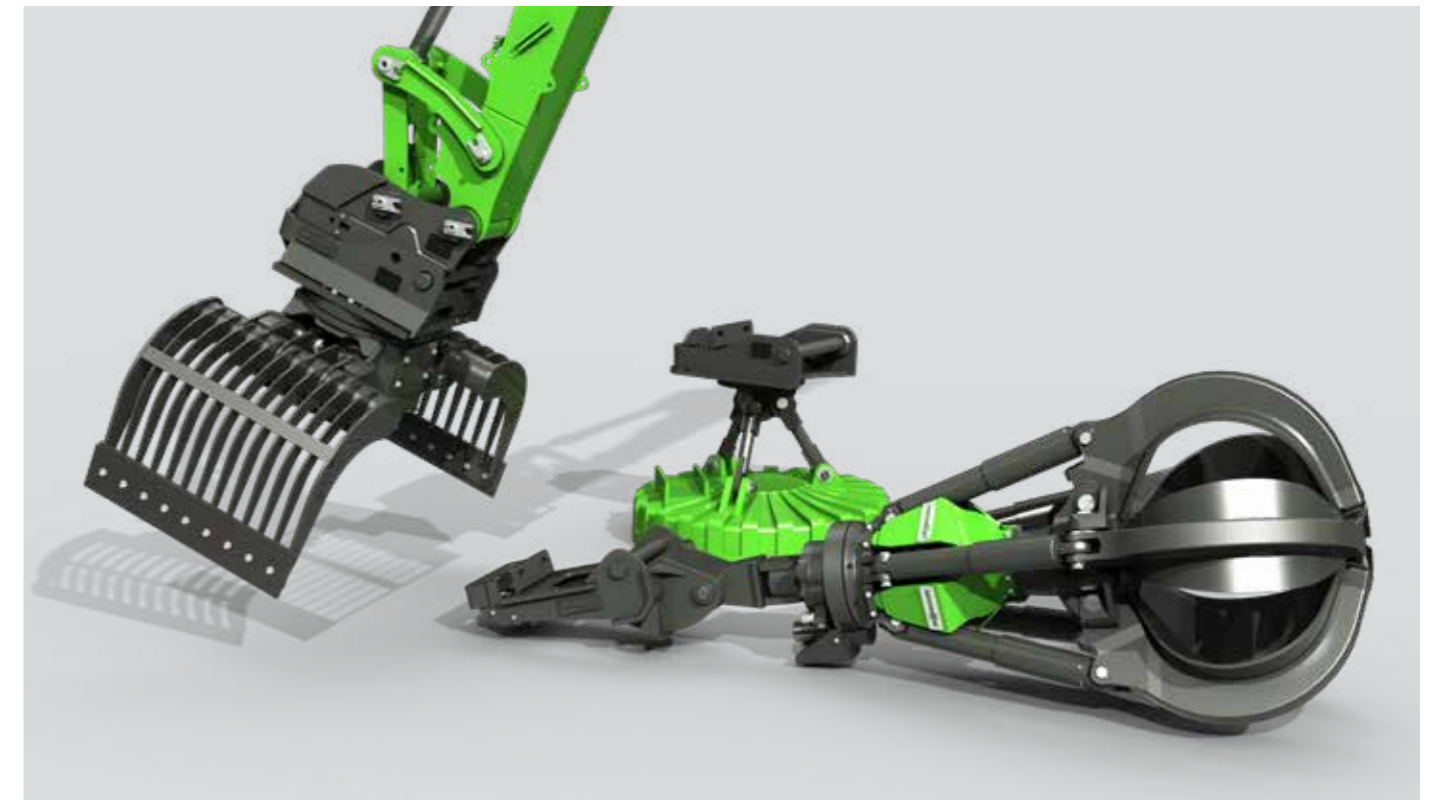

- » **Fully-hydraulic change device at the ULM-stick**
Vollhydraulisches Wechselsystem am ULM-Stiel

- » **Fast and safe changing of the attachments**
Schnelles und sicheres Wechseln der Anbaugeräte

- » **Also available with electric feed-through**
Auch Elektrodurchführung möglich



CUSTOMER SERVICE WORLDWIDE WELTWEIT

- / We support you with any questions online, by phone and on site with our worldwide network.
- / Wir unterstützen Sie bei Fragen online, telefonisch und mit unserem Netzwerk weltweit vor Ort.
- / Our extended warranty packages offer you even more security and service.
- / Unsere erweiterten Gewährleistungspakete bieten Ihnen noch mehr Sicherheit und Service.

SPARE PARTS: GO FOR QUALITY

ERSATZTEILE: SETZEN SIE AUF QUALITÄT



Excellent delivery performance - also in urgent cases

Exzellente Lieferperformance - auch in dringenden Fällen



Supply of spare parts to all continents through our global network

Ersatzteilversorgung auf allen Kontinenten durch unser weltweites Netzwerk



Automated warehouse technology for more than 30 000 items in stock

Automatisierte Lagertechnik für mehr als 30 000 vorrätige Artikel



Lower service costs with the use of high-quality SENNEBOGEN spare parts

Niedrige Servicekosten durch Verwendung von hochwertigen SENNEBOGEN Ersatzteilen

RENT MACHINES FLEXIBLY

MASCHINEN FLEXIBEL MIETEN

Our rental park enables you to rent machines on a medium or long-term basis:

- / for specific projects
- / to fill short-term gaps in your machine park
- / ensure the continued flow of goods

Unser Mietpark ermöglicht Ihnen, mittel- oder langfristig Maschinen anzumieten:

- / projektbezogen
- / um kurzfristig Lücken im Maschinenpark zu füllen
- / um Warenströme zu gewährleisten

SENNEBOGEN rental

rental.sennebogen.com



USED MACHINES WITH HIGH QUALITY

GEBRAUCHTMASCHINEN MIT HOHER QUALITÄT

Used machines have lower investment costs and still offer a high quality and durability! Find your used machine at SENNEBOGEN used!

Gebrauchtmaschinen haben einen geringeren Investitionsaufwand und bieten dennoch eine hohe Qualität und Lebensdauer! Finden Sie ihre Gebrauchtmachine bei SENNEBOGEN used!

SENNEBOGEN used

used.sennebogen.com

SENNEBOGEN ACADEMY

Expansive in knowledge, because success is based on knowledge. At the SENNEBOGEN Academy we place great importance on ensuring it flows powerfully.

Expansiv im Wissen, denn Erfolg beruht auf Wissen. In der SENNEBOGEN Academy legen wir Wert darauf, dass es kraftvoll fließt.

➔ www.sennebogen-academy.com



TARGET GROUP ORIENTED TRAINING
for our dealers and customers.

ZIELGRUPPENGERECHTES TRAINING
für unsere Händler und Kunden.



15 000 m² OUTDOOR DEMONSTRATION AREA
combines theory and practice in our training courses optimally.

15 000 m² VORFÜHRGELÄNDE
vereint Theorie und Praxis in unseren Trainings.



TRAINING CREATES AN ADVANTAGE
we offer a wide range of trainings from basic training to product expert trainings.

AUSBILDUNG SCHAFFT VORSPRUNG
In unseren Kursen bilden wir Basis- bis Expertentrainings an.



OPTIMAL KNOWLEDGE TRANSFER
Through trainings for service and sales partners we ensure the continuous operation of our machines worldwide.

OPTIMALER WISSENSTRANSFER
Trainings für Service- und Vertriebspartner sorgen für den reibungslosen Betrieb unserer Maschinen weltweit.

SENtrack



**FLEET MANAGEMENT
FOR PROFESSIONALS**

**FUHRPARKMANAGEMENT
FÜR PROFIS**

1. REDUCE SERVICE COSTS

Monitor the machine and its main operating parameters (temperatures, consumption). If key figures deviate significantly from the target value, the user is informed immediately.

2. REDUCE CONSUMPTION

Easily identify and optimize idle times or change set parameters when machines are underloaded to reduce consumption.

3. IMPROVE PRODUCTIVITY

With just a few clicks, you can identify and optimize machine capacity, analyze routes and thus make your processes more profitable.

4. SAFEGUARD YOUR INVESTMENT

Alarm messages inform you about critical machine conditions. In the event of irregular movements, the machine can also easily be deactivated remotely.

➔ www.sennebogen.com/sentrack

1. SERVICEKOSTEN SENKEN

Überwachen Sie die Maschine und ihre wichtigsten Betriebsparameter (Temperaturen, Verbrauch). So erkennen Sie Abweichungen frühzeitig.

2. VERBRAUCH REDUZIEREN

Identifizieren und optimieren Sie Leerlaufzeiten der Maschinen oder ändern Sie Einstellungsparameter bei Unterlast, um so den Verbrauch zu reduzieren.

3. PRODUKTIVITÄT VERBESSERN

Mit nur wenigen Klicks erkennen und optimieren Sie die Auslastung der Maschinen, können Fahrstrecken analysieren und dadurch Ihre Prozesse gewinnbringend umgestalten.

4. INVESTITION ABSICHERN

Alarmmeldungen informieren Sie über kritische Zustände der Maschine. Bei irregulären Bewegungen lässt sich die Maschine zudem bequem aus der Ferne deaktivieren.



MOVE BIG THINGS WITH US



SENNEBOGEN IN FIGURES. *SENNEBOGEN IN ZAHLEN.*



2200+

Employees worldwide
Mitarbeiter weltweit



180+

Sales and service partners worldwide
Vertriebs- und Servicepartner weltweit



100+

Countries worldwide which we export to
Länder weltweit, in die wir exportieren



72+

Years of experience
Jahre Erfahrung

JOIN OUR OPERATORS' CLUB

Exclusive information, sharing experience with other SENNEBOGEN operators as well as fun and enthusiasm. All the benefits here:

WERDEN SIE MITGLIED IM FAHRERCLUB

Exklusive Informationen, Erfahrungsaustausch mit SENNEBOGEN-Fahrern sowie Spaß und Begeisterung. Alle Vorteile unter:



[www.sennebogen.com/
en/the-company/operators-club](http://www.sennebogen.com/en/the-company/operators-club)

BIG RANGE OF PRODUCTS. EXCELLENT RANGE OF SIZES.

RIESIG IM SORTIMENT. FEIN IM GRÖSSENRASTER.



Telehandler
Teleskoplader
4-5,5 t

Balancer
130-300 t

Material handler
Materialumschlag
17-420 t

Duty cycle crane
Seilbagger
13,5-300 t

Crawler crane
Raupenkran
50-300 t

Telescopic crane
Teleskopkran
16-130 t

Port crane
Hafenkran
300 t



SENNEBOGEN
Maschinenfabrik GmbH
 Hebbelstraße 30
 94315 Straubing, Germany
 Tel. +49 94 21 540-0
 Fax +49 94 21 43882
 marketing@sennebogen.de
 www.sennebogen.com

SENNEBOGEN LLC
 1957 SENNEBOGEN Trail
 Stanley, North Carolina 28164, USA
 Tel. +1 704 347-4910
 Fax +1 704 347-8894
 sales@sennebogenllc.com
 www.sennebogen-na.com

SENNEBOGEN Pte. Ltd.
 25 International Business Park
 # 04-11/12 German Centre
 Singapore 60 99 16
 Tel. +65 6562 826-0
 Fax +65 6562 826-1
 info@sennebogen.asia
 www.sennebogen.asia

Detailed product brochures on request:

The technical data and charts included in this brochure are for general information only. No responsibility is taken for the correctness of the details provided. This information is subject to technical modifications, changes in equipment and enhancements. The pictures may include optional equipment.

Fragen Sie bitte nach detaillierten Produktbroschüren:

Die Daten und Übersichtstabellen dieser Broschüre dienen nur zur allgemeinen Information. Alle Angaben sind ohne Gewähr. Technische Änderungen, Ausstattungsänderungen und Weiterentwicklungen vorbehalten. Geräteabbildungen können Sonder- und Zusatzausstattungen enthalten.